

2016



GHOST

GHOST

LEGENDS REBORN

ENG

BUILDING ON THE PAST, HEADING FOR THE FUTURE.

LECTOR was the first high-end hardtail in our history. The AMR was our very first carbon full suspension model and RIOT was the first bike featuring our unique suspension technology. They are here again, reborn, and their quality speaks for itself.

Having already won industry awards, the new LECTOR is drawing the attention of bike fans and media, even prior to its official unveiling. RIOT, a multi-award winning bike, is no longer a standalone with the introduction of the hard charging PathRIOT. The new AMR platform will become our future flagship confirming our constant pursuit of simple perfection. Perfection is always our aim, and is a word which hopefully best describes our approach to product development.

And as proof that our focus is not directed only at mountain bikes, we're introducing a completely new Cross-Trekking-Urban line called SQUARE. Consisting of more than 40 models, packed with stunning design ideas, inventive technical features and smartly engineered details. We believe the SQUARE will set the benchmark for this whole segment. Teru LC – one of the lightest bikes in the market – will get even stronger with the new Bosch Performance CX engine as our Fully-E-HyBRIDE range. All of our Nivolet Tour models get what they deserve, the same lightweight, super-stiff frame seen in our top models.

All this said, we trust this year will reward you with bikes that are both reborn and newborn. Enjoy.

GER

DIE VERGANGENHEIT IM KOPF. DIE ZUKUNFT IM BLICK.

Perfektion entsteht, wenn man auf Überflüssiges verzichtet. Wenn man Dinge klarer, einfacher und damit funktionaler macht. Wenn wir ein neues Produkt entwickeln, ist Perfektion unser Ziel. Und dass wir das erreichen, haben wir in der Vergangenheit schon oft bewiesen.

Mit Rädern wie dem LECTOR, unserem neuen High-End-Hardtail, dem AMR, unserem ersten Carbon-Fully, oder dem RIOT, unserem ersten Bike mit preisgekröntem Fahrwerk, setzten wir immer wieder Meilensteine in unserer Firmengeschichte. Mit der gleichen Perfektion sind auch die neuen Modelle dieser Saison entwickelt worden. Zum Beispiel das neue LECTOR, das bereits vor seiner offiziellen Vorstellung Journalisten und Bike-Enthusiasten den Kopf verdreht hat. Das vielfach preisgekrönte RIOT, das mit dem PathRIOT endlich einen Verwandten an seiner Seite hat und natürlich unserem Aushängeschild, der neuen AMR-Reihe.

Es dreht sich aber nicht alles nur um Trails und Mountainbikes. Das beweist unsere neue Cross-Trekking-Urban-Produktlinie SQUARE. Sie besteht aus mehr als 40 Modellen, vollgepackt mit cleveren technischen Details und innovativen Features. Diese Serie wird in ihrem Segment Maßstäbe setzen! Das Teru LC ist eines der leichtesten E-Bikes auf dem Markt und mit dem neuen Bosch-Performance-CX-Motor wird es – wie auch unsere anderen E-Modelle – noch leistungsfähiger. Unsere Nivolets LC bekommen, was sie verdienen: Sie bauen auf dem super-leichten und supersteifen Rahmen auf, den man schon von unseren Topmodellen kennt, und werden mit innovativen Komponenten wie zum Beispiel Scheibenbremsen ausgestattet.

Wir freuen uns auf ein neues Jahr mit unseren neuen Bikes und sind überzeugt: Mit diesem Line-up wurden nicht nur große Legenden wiedergeboren, es haben auch einige neue das Licht der Welt erblickt.



PRODUCT NAMING

ENG

Introducing new products this year means new names, so we're using this opportunity to take the next step in simplifying our naming system based on feedback we have received from our customers. To better familiarize you with all the new products, we have prepared a simple overview table.

GER

Neue Produkte brauchen neue Namen. Also nutzen wir die Gelegenheit, um die Systematik unserer Modelle zu vereinfachen – ganz so, wie es uns das Feedback unserer Kunden nahegelegt hat. Damit du dich mit all den neuen Produkten vertraut machen kannst, haben wir eine einfache Übersichtstabelle für dich vorbereitet.



NAME	FRAME MATERIAL			E-BIKE	CATEGORY	SUB-CATEGORY	GENDER		TRAVEL		WHEELS
	ULC	LC	AL				MAN	MISS	FRONT	REAR	
PATHRIOT		●			MTB FULL SUSPENSION	ENDURO RACE	●		170	150	27,5
RIOT		●			MTB FULL SUSPENSION	ALL MOUNTAIN	●		150/130	130	27,5
SL AMR		●	●		MTB FULL SUSPENSION	ALL MOUNTAIN	●		130	130	27,5
SL AMR X		●	●		MTB FULL SUSPENSION	ALL MOUNTAIN	●		150/130	145	27,5
FR AMR		●	●		MTB FULL SUSPENSION	ENDURO	●		160	160	27,5
AMR		●	●		MTB FULL SUSPENSION	ALL MOUNTAIN	●		130	120	29
KATO FS			●		MTB FULL SUSPENSION	ALL MOUNTAIN	●		130	130	27,5
LECTOR	●	●			MTB HARDTAIL	XC RACE	●		100		29
ASKET		●			MTB HARDTAIL	XC TRAIL	●		130		27,5
TACANA			●		MTB HARDTAIL	XC TOUR	●		100		29
TACANA X			●		MTB HARDTAIL	XC RACE	●		100		29
KATO			●		MTB HARDTAIL	XC TOUR	●		120		27,5
KATO X			●		MTB HARDTAIL	XC TRAIL	●		120		27,5
SONA			●		MTB HARDTAIL	XC TOUR	●		100		26
NILA		●			MTB HARDTAIL	XC RACE	●	●	100		27,5
LANAO FS			●		MTB FULL SUSPENSION	ALL MOUNTAIN		●	130	130	27,5
LANAO			●		MTB HARDTAIL	XC TOUR		●	100		27,5
LAWU			●		MTB HARDTAIL	XC TOUR		●	100		26
TERU FS			●	●	MTB FULL SUSPENSION	ALL MOUNTAIN	●		130	120	29
TERU FS X			●	●	MTB FULL SUSPENSION	ALL MOUNTAIN	●		150	140	27,5
TERU		●	●	●	MTB HARDTAIL	XC TOUR	●	●	120		27,5
ANDASOL CROSS			●	●	LANE	COUNTRY	●	●	60		28
ANDASOL TREKKING			●	●	LANE	TREKKING	●	●	60		28
ANDASOL WAVE			●	●	LANE	WAVE	●	●	60		28
SQUARE CROSS			●		LANE	COUNTRY	●	●	60		28
SQUARE CROSS X			●		LANE	COUNTRY	●	●	60		28
SQUARE TREKKING			●		LANE	TREKKING	●	●	35, 40, 50		28
SQUARE URBAN			●		LANE	URBAN	●	●			28
SQUARE URBAN X			●		LANE	URBAN	●	●			28
NIVOLET RACE	●	●			ROAD	RACE	●				28
NIVOLET TOUR		●	●		ROAD	ENDURANCE/COMFORT	●				28
NIVOLET TOUR DISC		●			ROAD	ENDURANCE	●				28
POWERKID			●		MTB HARDTAIL	KID	●	●	50		12, 16, 20, 24
HTX EBS		●			MTB HARDTAIL	XC RACE	●		100		29

FROM SKETCH TO TRAIL AND BACK

ENG

Our R&D team consists of highly educated engineers, who are even more importantly also passionate bike riders. Their passion is reflected in every piece of their work. It all starts with the sketch, which is the very first step in the long development process. Next, the work continues digitally as the sketches are transformed using sophisticated 3-D software to create the lightest, stiffest and most efficient bikes possible. Prototypes undergo the toughest, most precise evaluations on our test rigs to guarantee durability and safety. In the final step, the prototype bikes leave the laboratory for testing under real riding conditions by our team of professional racers. They provide feedback to our engineers to get what they most want in high performance racing machines. What you get in the end are the finest bicycles in the world.

GER

Unsere Entwickler sind erfahrene Ingenieure. Aber was fast noch wichtiger ist, sie sind leidenschaftliche Biker. Am Anfang jeder Entwicklung steht eine Idee, eine Inspiration oder Vision. In einer ersten Skizze nimmt diese Gestalt an und wird mit Hilfe modernster 3-D-Visualisierungen und Simulationen am Computer weiter ausgearbeitet. Danach werden die ersten Prototypen auf unseren Prüfständen auf Mark und Bein getestet. Nur so können wir Haltbarkeit und Sicherheit unserer Produkte gewährleisten. Und schließlich der vielleicht wichtigste Schritt im Prozess: Die Prototypen verlassen das Labor und werden von unseren Teamfahrern unter realen Bedingungen auf Herz und Nieren getestet. Die Erfahrungen aus der Praxis lassen unsere Ingenieure direkt wieder in den Entwicklungsprozess einfließen, sodass am Ende Fahrräder stehen, auf die alle stolz sind – die Konstrukteure gleichermaßen wie die Menschen, die sie fahren.

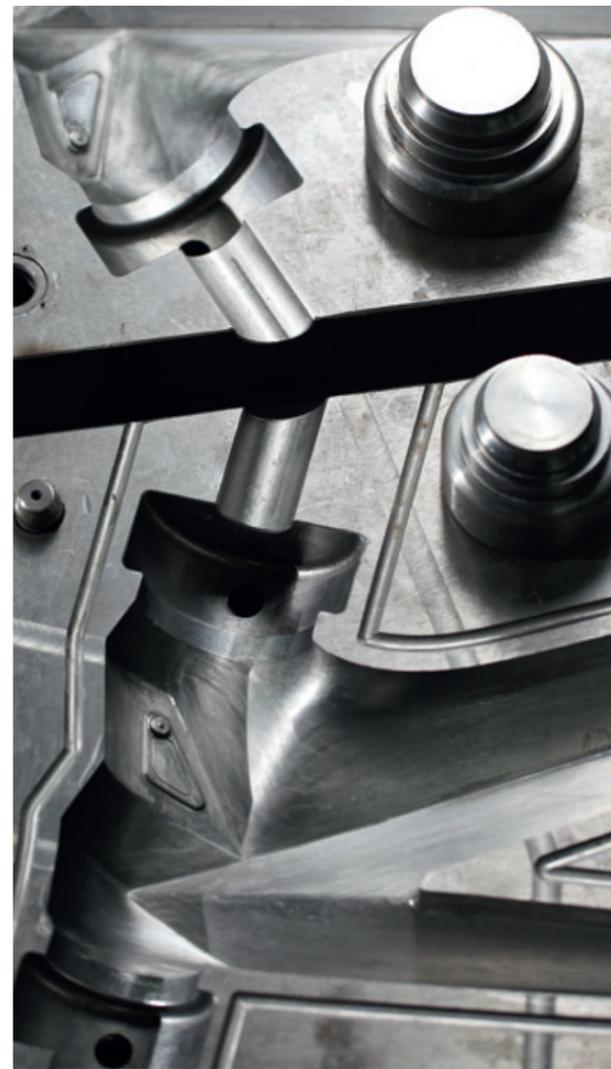

RIOT-LINK

ENG

The innovative and patent-pending RIOT-link not only represents the new benchmark in the bicycle industry, it is a revolution in terms of rear suspension. It provides a completely new experience on the trail, because the RIOT-link system allows you to ride faster than you ever did before, and the unprecedented control makes every ride safer!

Technically speaking, the RIOT-link is a mechanical system using a floating shock that is compressed from both sides. The continuous interaction of upper and lower rocker is the key to the RIOT-link's ultimate kinematics performance. While the upper rocker controls the first 80% of the travel efficiently, the lower RIOT-rocker takes over as travel progresses, and provides optimum bottom-out protection during the last 20% of travel. This unique combination results in a whole new performance level.

GER

Das von Grund auf neu entwickelte und zum Patent angemeldete RIOT-Link setzt nicht nur neue Maßstäbe in der Fahrradindustrie, sondern ist sogar eine Revolution in Sachen Hinterradfederung. Die Erfahrung auf dem Trail ist eine vollkommen neue, weil dir das RIOT-Link-System erlaubt, schneller als je zuvor zu fahren. Die überragende Kontrolle, die es bietet, macht jede Fahrt sicherer! Technisch betrachtet arbeitet das RIOT-Link-System mit einem schwimmend aufgehängten Floating-Federbein, das von beiden Seiten angesteuert wird. Das kontinuierliche Zusammenspiel von oberem und unterem Rocker ist entscheidend für die Kinematik-Performance des RIOT-Link. Während der obere Rocker maßgeblich für die Kontrolle der ersten 80 Prozent des Federwegs verantwortlich ist, gewinnt der unten liegende RIOT-Rocker mit zunehmendem Federweg an Einfluss und stellt auf den letzten 20 Prozent des Federwegs optimalen Durchschlagschutz bereit. Das Ergebnis dieser einzigartigen Kombination ist ein völlig neues Leistungsniveau.



MORE INFO
www.ghost-bikes.com/riot

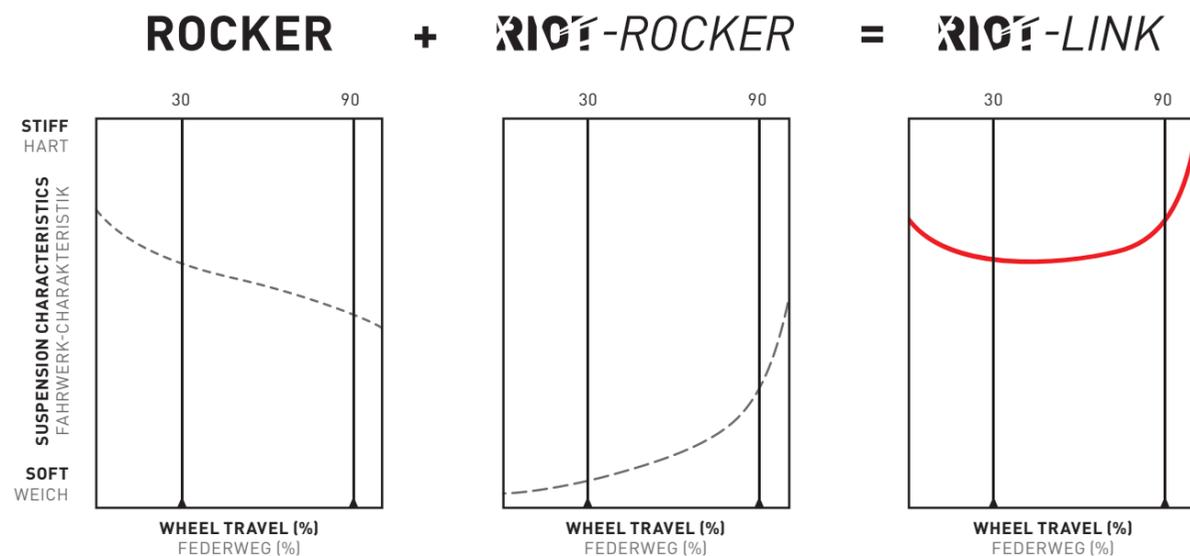

E – HYBRIDE

ENG

Our entire E-HyBRIDE series has been redesigned. These new pedelecs are equipped with the latest Bosch motors in order to guarantee the greatest possible range and reliability. All models designed for sporting use feature best-in-class Bosch Performance CX motors and 500 Wh batteries at an unbeatable price.

The highlight of our E-HyBRIDE series is the Teru LC 10 featuring a carbon fiber frame, premium components and an ultra-low overall weight of only 16.9 kg.

GER

Unsere neuen E-HyBRIDE-Modelle sind von Grund auf neu konstruiert worden. Wir statten unsere Pedelecs mit den neuesten Bosch-Motoren aus, um dir die größte Reichweite und Zuverlässigkeit zu garantieren. In allen Modellen, die für den sportlichen Einsatz gedacht sind, werden die High-Class Bosch-Performance-CX-Motoren und 500 Wh Akkus verbaut – und das zu einem unschlagbaren Preis.

Das Highlight unter unseren E-HyBRIDEs ist das ultraleichte Teru LC 10 mit Carbonrahmen, besten Komponenten und einem Gewicht von nur 16,9 Kilogramm.



 **BOSCH**



TECHNOLOGY

ENG

HYDROFORMED ALUMINUM

The hydroforming process optimizes every area of the frame for best stiffness and optimized force flow. Additionally, it provides freedom for creative tube designs.

GER

Der Hydroforming-Prozess erzielt bestmögliche Steifigkeit und optimalen Kraftfluss für jedes einzelne Rahmensegment. So haben wir Freiheit für kreatives Rohrdesign.

LC – LIGHTWEIGHT CARBON

Stiff, strong and made with precision. Our carbon process specifies the material lay-up in every area of the frame to optimize ride quality and ensure the best possible strength-to-weight ratio.

Steif, stark und mit Präzision gefertigt. Unser Carbon-Prozess wird durch Schichtaufbau an jedem Rahmenpunkt optimiert und bietet bestmögliches Leistungs-Gewicht-Verhältnis.

ULC – ULTRA LIGHTWEIGHT CARBON

Stiff, strong and made with precision. Our carbon process specifies the material lay-up in every area of the frame and ensures the best possible strength-to-weight ratio.

Im präzisen Fertigungsprozess kommen die stärksten Carbonfasern zum Einsatz. Durch eine optimierte Materialverteilung erreichen wir maximale Steifigkeit bei weniger Materialverbrauch und damit minimalem Gewicht.

COMPOSITE BUSHINGS

Innovative, lightweight composite bushings when mated with hard anodized aluminum axles create very little friction, are maintenance free for long life, and offer excellent stiffness for suspension systems.

Innovative, superleichte Kompositlager mit harteloxierten Aluminiumachsen sorgen für minimale Reibung. Die wartungsfreien Kompositlager garantieren zudem eine sehr lange Lebensdauer und hohe Steifigkeit für das Federungssystem.

ISCG

The International Standard Chain Guide is a standardized 3-point system allowing the mounting of chain guides directly to the bottom bracket area. Mounting chain guides no longer requires disassembly of the bottom bracket!

Der International Standard Chain Guide ist eine genormte 3-Punkt-Befestigung von Kettenführungen direkt am Tretlagergehäuse. Bei der Montage von Kettenführungen muss das Tretlager nicht mehr ein- oder ausgebaut werden.

FOUR BAR LINKAGE

Proven for years, this reliable suspension system uses an advanced principle where braking forces don't influence the suspension performance. It guarantees maximum pedal efficiency and traction both up and down the hill.

Seit Jahren bewährt – diese verlässliche Hinterradfederung arbeitet nach einem fortschrittlichen Prinzip, bei dem die Bremskräfte die Federungsfunktion nicht beeinflussen. So sind maximale Tritteffizienz und Traktion garantiert – bergauf und bergab.

ENG

RIOT-LINK

The innovative and patent pending RIOT-link suspension system represents the new benchmark in the bicycle industry. RIOT-link is a mechanical system using a full floating shock that is compressed from both sides. All in one – the system offers higher pedal efficiency, unmatched sensitivity through the first 80% of the travel and high progressivity during the last 20% of the travel, making it impossible to bottom out.

GER

Das von Grund auf neu entwickelte und zum Patent angemeldete RIOT-Link ist der neue Maßstab in der Fahrradindustrie. RIOT-Link ist ein mechanisches System mit einem schwimmend aufgehängten Federbein, das von beiden Seiten angesteuert wird. All in one – das System bietet bessere Antriebsneutralität, beispielloses Ansprechverhalten auf den ersten 80 Prozent des Federwegs und hohe Progressivität auf den letzten 20 Prozent. Durchschläge werden so verhindert.

X12 AXLE

The hub axle clamps tightly into the rear triangle under great axial tension, making the whole system very light and yet super stiff.

Die Nabenachse wird unter großer axialer Spannung fest in den Hinterbau geklemmt, wodurch am ganzen System viel Gewicht eingespart werden kann und hohe Steifigkeit erzielt wird.

DISCONNECT BRAKE MOUNT

Innovative connection of rear brake directly onto the X12 axle. This solution lowers weight, reduces stress on the rear triangle and does not require threading anything into the frame for caliper installation. In its second generation, the mount has been streamlined for a lower profile, less weight, and a cleaner look.

Innovative, direkte Verbindung der Hinterradbremse mit der X12-Achse. Durch diese technische Lösung wird Gewicht reduziert und ein Teil der Kräfte von den Sitzstreben entkoppelt. Außerdem ist kein Gewinde im Rahmen für den Einbau des Bremsstellers notwendig. Die zweite Generation ist im Detail optimiert und perfekt auf das neue Rahmendesign angepasst.

BOSCH DRIVE

This electric drive unit delivers outstanding quality, performance and durability in the most practical designs. The easy to remove rechargeable battery pack and clean synoptic display provide a user-friendly experience and guarantee flawless performance.

Dieser Elektroantrieb garantiert hervorragende Qualität, Leistungsfähigkeit und Langlebigkeit in praktischem Design. Der aufladbare Akku-Pack ist leicht abnehmbar, und das clean gestaltete synoptische Display ist extrem benutzerfreundlich und garantiert die einwandfreie Funktion.

BIKE DESCRIPTIONS

ENG

In this chapter, we would like to explain our approach to outlining model specifications. We've added some extra specs to our tables, in particular trekking related components such as racks, fenders, kickstands and lights. In order to make the presentation and selling of our products more efficient, we're also introducing a brand new feature called spec change indicators. These are simple, easy-to-decipher icons indicating significant differences between models. On the left side of the column you will see upgrades to a higher model and, similarly on the right side the downgrades to the lower ones. A gray point reflects a value neutral difference between models. Finally, there is the wheel size information. As this is the single most requested piece of information, we have listed this next to every bicycle in the workbook.

GER

Um die Beratung und den Verkauf unserer Produkte noch einfacher zu machen, haben wir unsere Datenblätter überarbeitet. Wir haben einige zusätzliche Informationen integriert, insbesondere Trekking-Komponenten wie Gepäckträger, Schutzbleche, Fahrradständer und Lampen. Neu sind jetzt auch Icons, die auf den ersten Blick die Unterschiede zwischen den Modellen einer Serie markieren. Auf der linken Seite der Spalte sind die Upgrades zu den teureren Modellen gekennzeichnet und dementsprechend auf der rechten Seite Downgrades zu günstigeren Modellen. Ein grauer Punkt weist auf einen Ausstattungsunterschied hin, ohne diesen zu bewerten. Schließlich ist die Präferenz mancher Komponenten einfach eine Frage der persönlichen Vorliebe. Die Laufradgröße haben wir direkt neben jedem Fahrrad aufgeführt.

ULC LECTOR 10

●	DARKRED/BLACK
🔧	Lector 29 Carbon ULC
▲	🏠 Fox 32 Float Factory Kashima Remote 100 mm 15 mm
▲	🔧 Race Face Turbine 31.8 mm
▲	🔧 Race Face Next Carbon 720 mm 31.8 mm
●	🔧 Shimano XTR 11-Speed DI2
●	🔧 Shimano XTR DI2
●	🔧 Shimano XTR SL DI2
▲	🔧 Shimano XTR 36-26
▲	🔧 Shimano XTR 11-40
▲	🔧 Shimano XTR CC Disc 180/160 mm SMRT 86
▲	🔧 Schwalbe Rocket Ron/Thunder Burt Evo 2.25
▲	🔧 Tune
▲	🔧 Tune King 15 mm
▲	🔧 Tune Kong 12 mm
▲	🔧 GHOST SL Carbon 31.6 mm
▲	🔧 SD6 Circuit
→	XS/S/M/L/XL

ULC LECTOR 9

●	DARKRED/BLACK
🔧	Lector 29 Carbon ULC
▲	🏠 Fox 32 Float Factory Kashima Remote 100 mm 15 mm
▲	🔧 Race Face Turbine 31.8 mm
▲	🔧 Race Face Next Carbon 720 mm 31.8 mm
●	🔧 Shimano XTR 11-Speed
●	🔧 Shimano XTR
●	🔧 Shimano XTR SL
▲	🔧 Shimano XTR 36-26
▲	🔧 Shimano XTR 11-40
▲	🔧 Shimano XTR CC Disc 180/160 mm SMRT 86
▲	🔧 Schwalbe Rocket Ron/Thunder Burt Evo 2.25
▲	🔧 Tune
▲	🔧 Tune King 15 mm
▲	🔧 Tune Kong 12 mm
▲	🔧 GHOST SL Carbon 31.6 mm
▲	🔧 SD6 Circuit
→	XS/S/M/L/XL

LC LECTOR 8

●	BLACK/WHITE
🔧	Lector 29 Carbon LC
▲	🔧 Rock Shox SID RL 100 mm OneLoc 15 mm
▲	🔧 Race Face Turbine 31.8 mm
▲	🔧 Race Face Next Carbon 720 mm 31.8 mm
▲	🔧 Sram X01 11-Speed
▲	🔧 Sram X01 SL
▲	🔧 Sram GX1 1400 30
▲	🔧 Sram XG 1180 10-42
▲	🔧 Sram Guide RS Disc 180/160 mm
▲	🔧 Schwalbe Rocket Ron/Thunder Burt Evo 2.25
▲	🔧 Race Face Affect Wheelset
▲	🔧 Race Face Affect Wheelset 15 mm
▲	🔧 Race Face Affect Wheelset 12 mm
▲	🔧 GHOST SL Carbon 31.6 mm
▲	🔧 SD6 Circuit
→	XS/S/M/L/XL

● value neutral difference

○ no marks = no changes

KEY / LEGENDE

- ▲ upgrade / Upgrade
- ▼ downgrade / Downgrade
- value neutral difference / nicht vergleichbares Produkt

SIZING SYSTEM

ENG

After a transition year, the time to say good-bye to the old system has arrived. There are plenty of reasons, but the major one lies in the improvements we have made in bicycle ergonomics. Geometries have changed, and we believe that our new sizing system is the best way for our customers to choose the right frame size because it's universal and easy to understand. For those who prefer the traditional geometry tables, we will still include them at the end of the workbook. People often ask us for advice when they are unsure about which size to choose. The answer of our R&D team is simple in that a person's choice should reflect their riding style and skill level. Riders preferring more comfort and stability should opt for the bigger size, while those skilled riders who value agility and playfulness should choose the smaller sized option.

GER

Mit unserem neuen, einfachen und universellen Größensystem haben wir die klassischen Tabellen überflüssig gemacht. Wir sind überzeugt, dass es so für unsere Kunden deutlich einfacher ist, sich für die passende Rahmengröße zu entscheiden. Schließlich geht es bei dieser Entscheidung nicht nur um Millimeter- und Gradangaben. Einsatzgebiet und Können des Fahrers spielen eine wichtige Rolle. Wer sich mehr Komfort und Laufruhe wünscht, wählt einen größeren Rahmen. Fortgeschrittene Fahrer, die Wert auf Wendigkeit und verspielte Fahreigenschaften legen, wählen einen kleineren Rahmen. Aber keine Sorge: Wenn du eine traditionelle Geometrie-Tabelle bevorzugst, findest du diese am Ende dieses Workbooks.

HEIGHT in cm
KÖRPERGRÖSSE in cm

FRAME SIZE
RAHMENGRÖSSE

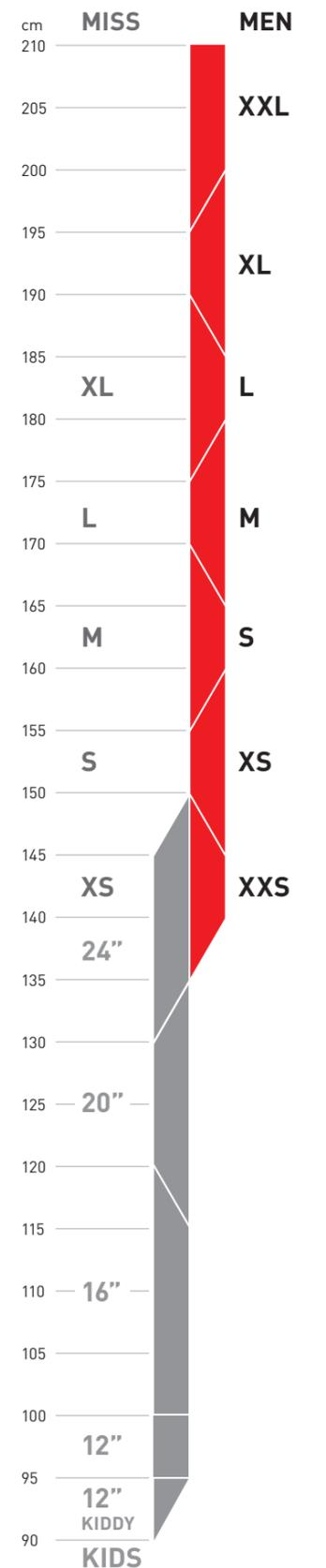
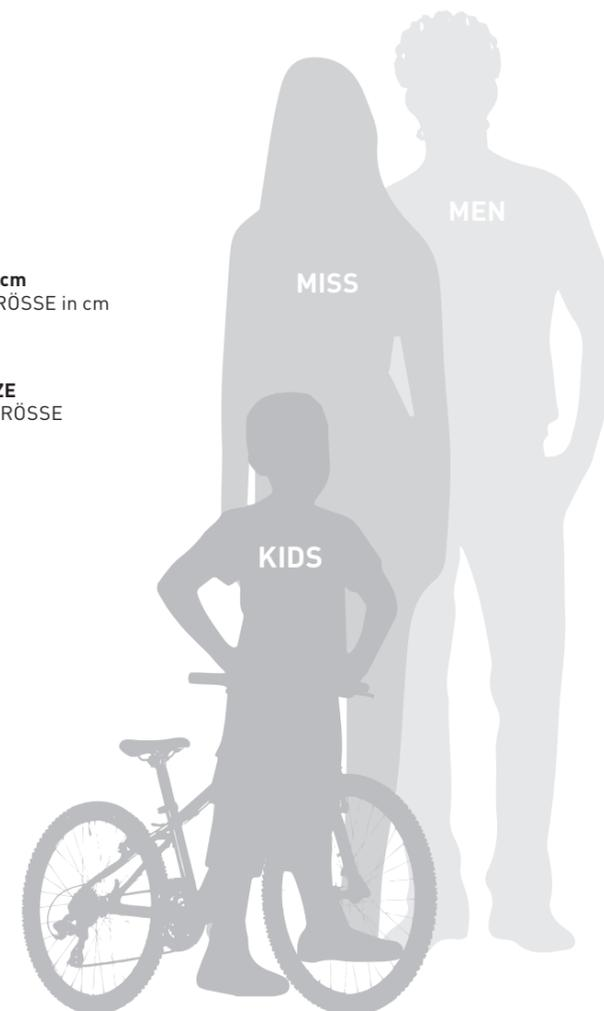

MYSTERIOUS X

ENG

X concepts represent a special new group of products in our portfolio. These are the products that may not neatly fit into a predefined product group. With X, we allow ourselves freedom to experiment and test our ideas without necessarily following "mainstream" market demand. X concepts represent our pure, uncompromised product ideals. Sometimes the X-ness stands for the Xtreme character of the product as a whole, and sometimes it represents a small, unXpected feature. This may be something as yet unseen which Xtends the value of the product. We hope to unveil more Xotic ideas every year, so from now on, whenever you see the big X, take note, because you will see something Xtra.

GER

Sie sind neu in unserem Portfolio: die Produkte mit dem „X“. Sie passen nicht in bestehende Schubladen, denn sie entstehen, wenn sich unsere Entwickler die Freiheit für Experimente nehmen. Wenn sie Ideen nachgehen und sich nicht um Trends und Moden kümmern. Unsere X-Gruppe repräsentiert unsere Vorstellungen davon, wie ein Produkt aussehen sollte – rein, unverfälscht und kompromisslos. Manche Produkte dieser Gruppe sind eXtrem, andere eXotisch oder überraschen durch ein eXtra oder ein besonders cleveres Feature. Wann immer du in Zukunft also einem Produkt mit einem „X“ begegnest, kannst du dir sicher sein, etwas ganz Besonderes in den Händen zu halten.

X TREME

X PERIMENTAL

X CITING

X PLORING

MAX I M A L

X PERIENCE

SE X Y

X T R A

X T E N D E D

X O T I C

UN X P E C T E D



GHOST FACTORY RACING TEAM

ENG

South Africa, Canada, Australia, USA, Germany. The toughest test rigs are the world's racetracks. In addition to countless tests in the lab, the ladies of our GHOST Factory Racing Team and their know-how are an invaluable part of our continuous development process. Our new hardtail is based on the experience and feedback of these world-class athletes, and our first bike in 20 years to proudly carry the LECTOR name.

Joining Double XCE World Champion Alexandra Engen, 2009 Overall World Cup winner Lisi Osl, 2010 European Champion Katrin Leumann, and Junior World Cup winner Greta Weithaler in GHOST Factory Racing Team colors for 2015 is the German mountain bike hope and U23 World Cup winner Helen Grobert.

In the end, there is a reason GHOST athletes stand with their bikes on the podiums of the world: Olympic Gold, World Cup victories, World Championship titles, Overall World Cup victories, European Championship titles, countless National Championship titles, Overall German Bundesliga victories. Our success story underlines the performance of our bikes, and every year a new chapter is written.

GER

Südafrika, Kanada, Australien, USA, Deutschland. Die härtesten Prüfstände sind die Rennstrecken rund um den Globus. Neben unzähligen Labortests sind die Ladies des GHOST Factory Racing Teams mit ihrem Know-how wertvoller Teil des ständigen Entwicklungsprozesses. Unser neues Hardtail basiert auf den Erfahrungen und dem Feedback der Weltklasse-athletinnen und ist seit 20 Jahren das erste Bike, dem wir mit Stolz wieder den Namen LECTOR gegeben haben.

Neben Doppelweltmeisterin im XCE Alexandra Engen, Gesamtweltcupsiegerin 2009 Lisi Osl, Europameisterin 2010 Katrin Leumann, Juniorenweltcupsiegerin Greta Weithaler startet seit 2015 auch die deutsche Mountainbikenachwuchshoffnung und U23-Weltcupsiegerin Helen Grobert in den Farben des GHOST Factory Racing Teams.

Am Ende stehen die GHOST-Athletinnen nicht ohne Grund zusammen mit ihren Bikes immer wieder auf den Podesten dieser Welt: olympisches Gold, Weltcup Siege, Weltmeistertitel, Weltcupgesamtsiege, Europameistertitel, unzählige nationale Meistertitel, Bundesligagesamtsiege. Die Erfolgsgeschichte unterstreicht die Leistungsfähigkeit unserer Bikes und wird Jahr für Jahr fortgeschrieben.



FOLLOW US ON FACEBOOK
facebook.com/ghostfactoryracing



GRAVITY RIDERS

JOHANNES FISCHBACH

2015 4X GERMAN CHAMPION, 2014 AND 2015 DH GERMAN CHAMPION

ENG

Johannes "Fischi" Fischbach is the uncontested Number One in German Downhill sports and always has a good result up his sleeve when it comes to World Cup and World Championship races. The rider from Northern Bavaria has been supported by GHOST since starting his career until reaching the pinnacle of his sport. As one of the world's best FourCross riders, Fischi decided to switch to Downhill, and practically overnight, became one of the fastest Downhill riders in the world. He is currently the German 4X and DH Champion, and remains the only rider to hold both titles at once.

Fischi is not only Germany's fastest Downhiller and GHOST team racer, but also one of our many test riders who put the bikes through their paces and give priceless feedback. Because of his many years of experience, and by testing the bikes in the toughest conditions possible, we are able to build the best bikes for you.

GER

Johannes „Fischi“ Fischbach ist die absolute Nummer eins im deutschen Downhillsport und bei Weltcups und Weltmeisterschaften immer für ein Topresultat gut. Der Oberpfälzer wurde von Beginn seiner Karriere an bis zur Weltspitze von GHOST begleitet. Als einer der weltbesten Fourcrosser wechselte Fischi ins Downhilllager und zählte sofort zu den Schnellsten der Welt. Aktuell ist er der erste Fahrer, der beide deutsche Meistertitel im 4X und DH auf sich vereinen konnte.

Fischi ist aber nicht nur Deutschlands schnellster Downhiller und GHOST-Teamfahrer, sondern einer unserer vielen Testfahrer, der unsere Bikes auf Herz und Nieren prüft und unschätzbare Feedback gibt. Durch seine jahrelange Erfahrung und den Einsatz unter härtesten Bedingungen können wir für dich die besten Bikes bauen.

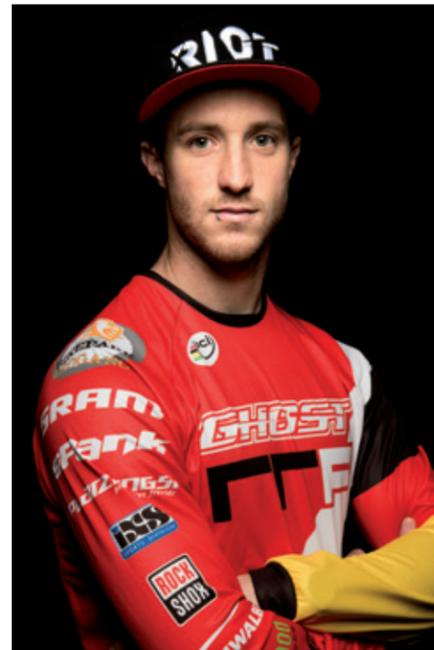

TOMAS SLAVIK

2014, 2010 4X WORLD CHAMPION

ENG

Tomas Slavik's name stands for FourCross like no other. This exceptional athlete from the Czech Republic has won almost everything there is to win in the last few years. His biggest dream came true though when he won his second World Championship title in Leogang, Austria. Aside from his many 4X World Series victories, he made his mark in the Downhill World Cup as well, and regularly outclasses his competitors in the City Downhill World Tour.

With great admiration we tip our hats to the master of mountain bike sports!

GER

Tomas Slavik, sein Name steht für Fourcross wie kein anderer. Der Ausnahmeathlet aus Tschechien konnte in den vergangenen Jahren fast alles gewinnen, was es zu gewinnen gab. Sein großer Traum ging jedoch mit seinem zweiten Weltmeistertitel in Leogang, Österreich, in Erfüllung. Neben zahlreichen Siegen bei der 4X World Series mischt er auch den Downhill-weltcup auf und deklassiert regelmäßig die Konkurrenz bei der City Downhill World Tour.

Wir verneigen uns vor dem Universalgenie des Mountainbikesports!



BIKE ANATOMY

- AVAILABLE FRAME SIZES
ERHÄLTICHE RAHMENGRÖSSEN
- WEIGHT
GEWICHT



HANGER
SCHALTAUGE

REAR DERAILLEUR
SCHALTWERK

FRONT DERAILLEUR
UMWERFER

CRANKSET
KURBELSATZ

BRAKES
BREMSEN

FRONT HUB
NABE VORNE

BIKE ANATOMY

- AVAILABLE FRAME SIZES
ERHÄLTICHE RAHMENGRÖSSEN
- WEIGHT
GEWICHT



7 KICK STAND
STÄNDER

8 HANGER
SCHALTAUGE

9 REAR DERAILLEUR
SCHALTWERK

10 ENGINE
MOTOR

11 CRANKSET
KURBELSATZ

12 BATTERY
BATTERIE

13 BRAKES
BREMSEN

14 FRONT HUB
NABE VORNE

15 RIM
FELGE

16 TIRES
REIFEN

17 LIGHTS REAR
RÜCKLICHT

18 CASSETTE
KASSETTE

19 CARRIER
GEPÄCKTRÄGER

20 REAR HUB
NABE HINTEN

21 SEATPOST
SÄTTELSTÜTZE

22 SADDLE
SÄTTEL

23 COLOR
FARBE

24 FRAME
RAHMEN

25 STEM
VORBAU

26 GRIPS
GRIFFE

27 HANDLEBAR
LENKER

28 SHIFTER
SCHALTHEBEL

29 HEADSET
STEUERSATZ

30 LIGHTS FRONT
SCHEINWERFER

31 FENDERS
SCHUTZBLECHE

32 FORK
GABEL

33 FRONT TRAVEL
FEDERWEG VORNE

**BIKES
2016**



PATHRIOT

ENG

This long awaited enduro crusher fills the final gap in our mountain line. It takes all the best from the RIOT and builds it bigger, better and burlier for hard charging riders and racers who demand nothing but the best. It took two years to develop and test this aggressive new design, and with its pure-bred styling and 150 mm of RIOT-link suspension in the rear and 170 mm up front, it's capable of plundering and plowing a path through even the roughest terrain. The PathRIOT's suspension will be powered by Cane Creek's new climb switch enabled Double Barrel coil shock for the ultimate in trail taming technology, and the optional front derailleur mount and ISCG 05 tabs give you the freedom to run a wide range of drivetrain setups.

GER

Das PathRIOT füllt die letzte Lücke in unserem Fullsuspension-Segment: In dieser lang erwarteten Enduro-Maschine findet sich das Beste des RIOT wieder – nur größer, besser und stabiler. Es ist ein Rad für Freerider und Enduro-Racer, die ihre Bikes hart rannehmen und für die nur das Beste gut genug ist. Es hat zwei Jahre gedauert, um dieses neue, aggressive Design zu entwickeln und zu testen. Mit der 150 Millimeter RIOT-Link-Hinterbaudämpfung und 170 Millimeter Federweg vorne bahnt sich dieses Bike seinen Weg selbst durch härtestes Gelände. Das Fahrwerk basiert auf dem sensibel ansprechenden, umschaltbaren Double Barrel Stahlfederdämpfer von Cane Creek. Damit ist das Bike mit Extra-Performance gerüstet, um bergab selbst anspruchsvollste Trails zu bändigen – und ist im Bergauf-Modus dank des zuschaltbaren Climb Switch trotzdem effizient pedalierbar. Die Halterung für einen optionalen Umwerfer und die ISCG 05 Aufnahme lässt dir bei der Entscheidung für den Antrieb die freie Wahl.



- BLACK/RED
- ▾ PathRiot 27.5 UHM/HM Carbon
- ▾ Fox 36 Float Factory Kashima 170 mm 15 DR
- Cane Creek Double Barrel Coil CS 150 mm
- ▾ Race Face Atlas 35 mm
- ▾ Race Face Sixc 800 mm 35 mm
- ▾ Sram XX1 11-Speed
- ▾ Sram XX1 SL
- ▾ Race Face Sixc 32
- ▾ Sram XG-1199 10-42
- ▾ Sram Guide RSC Disc 200/180 mm
- ▾ Schwalbe Magic Mary 2.35/Rock Razor 2.35
- ▾ Ryde Edge 28 OS
- ▾ Tune King 15 mm
- ▾ Tune King 12 mm
- ▾ Rock Shox Reverb Stealth 31.6 mm adjustable SR, internal routing
- ▾ SDG Circuit
- ▾ S/M/L



LC PATHRIOT 10

27.5

- BLACK/SILVER
- ▾ PathRiot 27.5 UHM/HM Carbon
- ▲ ▾ Fox 36 Float Performance Elite 170 mm 15 DR
- Cane Creek Double Barrel InLine 150 mm
- ▾ Race Face Atlas 35 mm
- ▲ ▾ Race Face Atlas 800 mm 35 mm
- ▲ ▾ Sram X01 11-Speed
- ▲ ▾ Sram X01 Trigger
- ▲ ▾ Sram X01 32
- ▲ ▾ Sram XG-1195 10-42
- ▲ ▾ Sram Guide RS Disc 200/180 mm
- ▲ ▾ Schwalbe Magic Mary 2.35/Rock Razor 2.35
- ▲ ▾ Easton ARC 27
- ▲ ▾ GHOST Light 15 mm
- ▲ ▾ GHOST Light 12 mm
- ▾ Rock Shox Reverb Stealth 31.6 mm adjustable SR, internal routing
- ▾ SDG Circuit
- ▾ S/M/L



LC PATHRIOT 8

27.5

RIOT

ENG

We've improved the frame, added new features and won even more awards. Why? We listened to feedback and united the best of the RIOT and RIOT LT into one ultimate trail bike. Thicker stanchioned 150 mm forks and improved shock tuning deliver ultimate compliance, and also help provide perfectly balanced kinematics. These optimized kinematics with more progressive travel deliver even more traction and all the confidence you need to pump into corners, preload jumps and tackle technical sections. To offer you unsurpassed performance throughout the complete model range, we've equipped every bike with the Cane Creek DB InLine shock, and replaced our previous bushings with lightweight Norglide composite bushings. Updated cockpit details like wider and stiffer handlebars further add to the point-and-shoot feel, and it all adds up to making the RIOT truly unstoppable. It's no wonder the RIOT has already won several major international awards.

GER

Das RIOT ist ein Bike, das alles mitmacht. In technischen Sektionen fährt es sich dank der verwindungssteifen Gabel und dem breiten Lenker ultrapräzise. Und wenn du in der nächsten Highspeed-Passage die Bremse öffnest, wirst du staunen, wie ruhig dieses Bike läuft. Vorne bügelt eine 150 Millimeter RockShox Pike das Gelände glatt und hinten versieht ein Cane Creek DB InLine Shock mit 130 Millimeter Federweg seinen Dienst. Aber dank des RIOT-Link fühlt sich diese Kombination nach deutlich mehr Federweg an. Dabei tritt sich das Bike erstklassig bergauf: Der neutrale Antrieb, die Seitensteifigkeit und die exzellente Traktion nehmen selbst steilen Rampen den Schrecken. Es ist ein Bike für jedes Gelände und alle Einsätze. Kein Wunder, das es mehr Branchenpreise gewonnen hat als jedes andere unserer Bikes.



LC RIOT 8

27,5

- BLACK / GREEN / DARKGREEN
- ▾ Riot 27.5 UHM / HM Carbon
- ▲ Rock Shox Pike RC Dual Air 150-120 mm
- ▾ Cane Creek Double Barrel InLine 130 mm
- ▾ Race Face Turbine 35 mm
- ▲ Race Face Turbine 760 mm 35 mm
- ▲ Shimano XT 11-Speed
- ▾ Shimano XT
- ▲ Shimano XT
- ▲ Shimano XT 36-26
- ▲ Shimano XT 11-42
- ▲ Shimano XT Disc 180 mm SMRT 66
- ▾ Schwalbe Nobby Nic 2.35 / 2.25
- ▲ Easton ARC 24
- ▲ GHOST Light 15 mm
- ▲ GHOST Light 12 mm
- ▲ Kind Shock Integra 31.6 mm adjustable SP, internal routing
- ▾ SDG Circuit
- ▾ XS / S / M / L / XL



LC RIOT 10

27,5

- BLACK / RED / DARKRED
- ▾ Riot 27.5 UHM / HM Carbon
- ▲ Rock Shox Pike RCT3 Dual Air 150-120 mm
- ▾ Cane Creek Double Barrel InLine 130 mm
- ▾ Race Face Turbine 35 mm
- ▾ Race Face Next Carbon 760 mm 35 mm
- ▾ Sram XX1 11-Speed
- ▾ -
- ▾ Sram XX1 SL
- ▾ Race Face Next 34
- ▾ Sram XG-1199 10-42
- ▾ Sram X.O Disc 180 mm
- ▾ Schwalbe Nobby Nic 2.35 / 2.25
- ▾ DT Swiss XMC 1200 Spline Wheelset
- ▾ DT Swiss XMC 1200 Spline Wheelset 15 mm
- ▾ DT Swiss XMC 1200 Spline Wheelset 12 mm
- ▾ Rock Shox Reverb Stealth 31.6 mm adjustable SP, internal routing
- ▾ SDG Circuit SL
- ▾ XS / S / M / L / XL



- BLACK / BLUE / DARKBLUE
- ▾ Riot 27.5 UHM / HM Carbon
- ▲ Rock Shox Pike RC Dual Air 150-120 mm
- ▾ Cane Creek Double Barrel InLine 130 mm
- ▲ Race Face Affect 35
- ▾ Race Face Affect 760 mm 35 mm
- ▾ Shimano XT 11-Speed
- ▾ Shimano XT
- ▾ Shimano XT
- ▾ Shimano XT 36-26
- ▾ Shimano XT 11-42
- ▲ Shimano Deore Disc 180 mm
- ▾ Schwalbe Nobby Nic 2.35 / 2.25
- ▾ Easton ARC 24
- ▾ GHOST Light 15 mm
- ▾ GHOST Light 12 mm
- ▾ Kind Shock Integra 31.6 mm adjustable SP, internal routing
- ▾ SDG Circuit
- ▾ XS / S / M / L / XL



LC RIOT 6

27,5

SLAMR

ENG

Super Light AMR is a new version of our legendary all rounder. For the first time in GHOST history, the SL AMR represents a bike built as part of a platform. It shares frame technologies with its siblings, which is the key to delivering great quality for an outstanding price. With its aggressive, edgy shapes, it offers the original RIOT-styling at an affordable price. It features the most up to date industry technologies, benchmark components and a super-light anodized rear triangle with a unique chain stay yoke. Its torsion cross provides an unprecedented internal cable routing solution and stiffness like never before. Most of the braking forces are absorbed by our second generation disconnect brake mount which attaches directly to the X12 rear axle. You will love unleashing the full potential of this machine while pushing your own limits as well. It's time to slam the trails!

GER

Wir haben das AMR auf Diät gesetzt: Die neue Generation unseres legendären Allrounders hat noch einmal etliche Gramm abgespeckt und ist leichter als je zuvor. Das SL AMR bietet neueste Technologien, beste Komponenten und das preisgekrönte Design des RIOT zum Preis eines AMR. Der extrem leichte, anodisierte Hinterbau überzeugt durch eine innovative, innen verlegte Kabelführung und eine nie zuvor da gewesene Steifigkeit. Der größte Teil der Bremskräfte wird von der neuen Generation unseres Disconnect Brake Mounts direkt auf die X12 Hinterradachse weitergeleitet. Du wirst dieses Bike lieben – und wenn du sein ganzes Potenzial ausreizt, wirst du die Grenzen dessen, was dir auf Trails möglich ist, neu definieren.



●	GREY/BLACK
↗	SL AMR LC AL
h	Fox 34 Float Factory Kashima 130 mm 15 mm
h	Fox Float DPS Factory Kashima 130 mm
☞	Race Face Turbine 35 mm
☞	Race Face Next 740 mm 35 mm
☞	Shimano XTR 11-Speed Plus
☞	Shimano XTR
☞	Shimano XTR SL
☞	Race Face Next 36-26
☞	Shimano XTR 11-40
☞	Shimano XTR AM Disc 180 mm SMRT 99
☞	Schwalbe Nobby Nic Evo 2.25
☞	DT Swiss XMC 1200 Spline Wheelset
☞	DT Swiss XMC 1200 Spline Wheelset 15 mm
☞	DT Swiss XMC 1200 Spline Wheelset 12 mm
☞	Rock Shox Reverb Stealth 31.6 mm adjustable SP, internal routing
☞	SDG Circuit SL
☞	XS/S/M/L/XL



LC SLAMR 10

27.5

●	DARKRED/WHITE
↗	SL AMR LC AL
▲	h Fox 34 Float Performance Elite 130 mm 15 mm
▲	h Fox Float DPS Performance Elite 3 Pos 130 mm
☞	Race Face Turbine 35 mm
☞	Race Face Turbine 740 mm 35 mm
▲	☞ Shimano XT 11-Speed Plus
▲	☞ Shimano XT
▲	☞ Shimano XT SL
▲	☞ Shimano XT 36-26
▲	☞ Shimano XT 11-40
▲	☞ Shimano XT Disc 180 mm SMRT 81
☞	Schwalbe Nobby Nic Evo 2.25
▲	☞ Tune
▲	☞ Tune 27.5er Wheelset 15 mm
▲	☞ Tune 27.5er Wheelset 12 mm
▲	☞ Kind Shock Integra 31.6 mm adjustable SP, internal routing
▲	☞ SDG Circuit
☞	XS/S/M/L/XL



LC SLAMR 8

27.5

LC SLAMR 6

27,5



- BLACK/BLACK
- ▾ SLAMR LC AL
- ▲ Fox 32 Float Performance 130 mm 15 mm
- ▲ Fox Float DPS Performance 3 Pos 130 mm
- ▲ GHOST AS-GH4 31.8 mm
- ▲ GHOST Low Rizer 740 mm 31.8 mm
- Shimano XT 11-Speed Plus
- Shimano XT
- Shimano XT SL
- Shimano XT 36-26
- Shimano XT 11-40
- Shimano XT Disc 180 mm SMRT 64
- Schwalbe Nobby Nic Evo 2.25
- ▲ Black Jack Ready 25
- ▲ Shimano XT 15 mm
- ▲ Shimano XT 12 mm
- ▲ Kind Shock Cruxi 31.6 mm adjustable SP, internal routing
- SDG Circuit
- ▬ XS/S/M/L/XL

LC SLAMR 4

27,5



- DARKBLUE/WHITE
- ▾ SLAMR LC AL
- Fox 32 Float Performance 130 mm 15 mm
- Fox Float DPS Performance 3 Pos 130 mm
- GHOST AS-GH4 31.8 mm
- GHOST Low Rizer 740 mm 31.8 mm
- Shimano XT 11-Speed Plus
- Shimano XT
- Shimano XT SL
- ▲ Shimano FC-MT 700 36-26
- Shimano XT 11-40
- ▲ Shimano Deore Disc 180 mm SMRT 64
- Schwalbe Nobby Nic Evo 2.25
- Black Jack Ready 25
- ▲ Shimano Deore 15 mm
- ▲ Shimano Deore 12 mm
- Kind Shock Cruxi 31.6 mm adjustable SP, internal routing
- SDG Circuit
- ▬ XS/S/M/L/XL

LC SLAMR 6

27,5



- DARKGREEN/WHITE
- ▾ SLAMR LC AL
- ▲ Fox 32 Float Performance 130 mm 15 mm
- ▲ Fox Float DPS Performance 3 Pos 130 mm
- ▲ GHOST AS-GH4 31.8 mm
- ▲ GHOST Low Rizer 740 mm 31.8 mm
- Shimano XT 11-Speed Plus
- Shimano XT
- Shimano XT SL
- Shimano XT 36-26
- Shimano XT 11-40
- Shimano XT Disc 180 mm SMRT 64
- Schwalbe Nobby Nic Evo 2.25
- Black Jack Ready 25
- ▲ Shimano XT 15 mm
- ▲ Shimano XT 12 mm
- ▲ Kind Shock Cruxi 31.6 mm adjustable SP, internal routing
- SDG Circuit
- ▬ XS/S/M/L/XL

SLAMR 7

27,5



- DARKRED/BLACK/WHITE
- ▾ SLAMR AL
- Fox 32 Float Performance 130 mm 15 mm
- Fox Float DPS Performance 3 Pos 130 mm
- GHOST AS-GH4 31.8 mm
- GHOST Low Rizer 740 mm 31.8 mm
- Shimano XT 11-Speed Plus
- Shimano XT
- Shimano XT SL
- Shimano XT 36-26
- Shimano XT 11-40
- Shimano XT Disc 180 mm SMRT 64
- Schwalbe Nobby Nic Evo 2.25
- Black Jack Ready 25
- ▲ Shimano XT 15 mm
- ▲ Shimano XT 12 mm
- Kind Shock Cruxi 31.6 mm adjustable SP, internal routing
- SDG Circuit
- ▬ XS/S/M/L/XL

SLAMR 5

27,5



- GREY/BLACK/WHITE
- ▾ SLAMR AL
- h Fox 32 Float Performance 130 mm 15 mm
- ⚡ Fox Float DPS Performance 3 Pos 130 mm
- 🔪 GHOST AS-GH4 31.8 mm
- ⚡ GHOST Low Rizer 740 mm 31.8 mm
- 🦋 Shimano XT 11-Speed Plus
- 🦋 Shimano XT
- ⊕ Shimano XT SL
- ▲ 🦋 Shimano FC-MT 700 36-26
- 🎯 Shimano XT 11-40
- ▲ 🦋 Shimano Deore Disc 180 mm SMRT 64
- ⚙️ Schwalbe Nobby Nic Evo 2.25
- 👤 Black Jack Ready 25
- ▲ 🦋 Shimano Deore 15 mm
- ▲ 🦋 Shimano Deore 12 mm
- 🔑 Kind Shock Cruxi 31.6 mm adjustable SP, internal routing
- ⚡ SDG Circuit
- ▭ XS/S/M/L/XL

SLAMR 5

27,5



- DARKBLUE/BLACK/WHITE
- ▾ SLAMR AL
- h Fox 32 Float Performance 130 mm 15 mm
- ⚡ Fox Float DPS Performance 3 Pos 130 mm
- 🔪 GHOST AS-GH4 31.8 mm
- ⚡ GHOST Low Rizer 740 mm 31.8 mm
- 🦋 Shimano XT 11-Speed Plus
- 🦋 Shimano XT
- ⊕ Shimano XT SL
- ▲ 🦋 Shimano FC-MT 700 36-26
- 🎯 Shimano XT 11-40
- ▲ 🦋 Shimano Deore Disc 180 mm SMRT 64
- ⚙️ Schwalbe Nobby Nic Evo 2.25
- 👤 Black Jack Ready 25
- ▲ 🦋 Shimano Deore 15 mm
- ▲ 🦋 Shimano Deore 12 mm
- 🔑 Kind Shock Cruxi 31.6 mm adjustable SP, internal routing
- ⚡ SDG Circuit
- ▭ XS/S/M/L/XL

SLAMR X

ENG

The "black" series of the SL AMR line is for those who never have enough, because it delivers more suspension travel for more fun. SL AMR X Xtends the abilities of an already eXtremely capable bike and takes it up a couple notches. We equipped all of them with piggybacked shocks and travel-adjust forks to provide you more performance for every situation whether you're climbing, dicing or descending. Depending on what fork travel you choose, this bike's personality ranges from well-mannered trail bike to lightweight enduro weapon. Sounds good? We think so.

GER

Die Black Series unserer SL AMR Modellreihe ist für alle, die mehr wollen: mehr Federweg und noch mehr Spaß. SL AMR X erweitert das Einsatzspektrum eines ohnehin unglaublich potenten Bikes. Dämpfer mit Ausgleichsbehältern und absenkbare Gabeln erlauben noch mehr Performance in jeder Situation, im Anstieg genau wie in der Abfahrt. Je nachdem, wie du die Gabel einstellst, verändert sich der Charakter von einem Trailbike mit gutmütigem Handling hin zu einer extraleichten Enduro-Waffe. Du findest, das klingt gut? Ist es auch!



SLAMR X 10

27,5



- BLACK / RED / DARKRED
- ▾ SLAMR X LC AL
- ▾ Rock Shox Pike RCT3 Dual Air 150-120 mm 15 mm
- ▾ Rock Shox Monarch Plus RC3 Debon Air 150 mm
- ▾ Race Face Turbine 35 mm
- ▾ Race Face Next 760 mm 35 mm
- ▾ Sram XX1 11-Speed
- ▾ -
- ▾ Sram XX1 SL
- ▾ Race Face Next 32
- ▾ Sram XG-1199 10-42
- ▾ Sram Guide RSC Disc 180 mm
- ▾ Schwalbe Nobby Nic Evo 2.25 / 2.35
- ▾ DT Swiss XMC 1200 Spline Wheelset
- ▾ DT Swiss XMC 1200 Spline Wheelset 15 mm
- ▾ DT Swiss XMC 1200 Spline Wheelset 12 mm
- ▾ Rock Shox Reverb Stealth 31.6 mm adjustable SP, internal routing
- ▾ SDG Circuit SL
- ▾ XS/S/M/L/XL

SLAMR X 7

27,5



- BLACK / BLUE / DARKBLUE
- ▾ SLAMR X AL
- ▾ Fox 34 Talas Performance 150-130 mm 15 mm
- ▾ Fox Float X Performance 3 Pos 150 mm
- ▾ GHOST AS-M04 35 mm
- ▾ GHOST Rizer 760 mm 35 mm
- ▾ Shimano XT 11-Speed Plus
- ▾ Shimano XT
- ▾ Shimano XT SL
- ▾ Shimano XT 36-26
- ▾ Shimano XT 11-42
- ▾ Shimano XT Disc 180 mm SMRT 64
- ▾ Schwalbe Nobby Nic Evo 2.25 / 2.35
- ▾ Black Jack Ready 25
- ▾ Shimano XT 15 mm
- ▾ Shimano XT 12 mm
- ▾ Kind Shock Cruzi 31.6 mm adjustable SP, internal routing
- ▾ SDG Circuit
- ▾ XS/S/M/L/XL

SLAMR X 8

27,5



- BLACK / GREEN / DARKGREEN
- ▾ SLAMR X LC AL
- ▾ Fox 34 Talas Performance 150-130 mm 15 mm
- ▾ Fox Float X Performance 3 Pos 150 mm
- ▾ Race Face Affect 35 mm
- ▾ Race Face Affect 760 mm 35 mm
- ▾ Shimano XT 11-Speed Plus
- ▾ Shimano XT
- ▾ Shimano XT SL
- ▾ Shimano XT 36-26
- ▾ Shimano XT 11-42
- ▾ Shimano XT Disc 180 mm SMRT 64
- ▾ Schwalbe Nobby Nic Evo 2.25 / 2.35
- ▾ Black Jack Ready 25
- ▾ Shimano XT 15 mm
- ▾ Shimano XT 12 mm
- ▾ Kind Shock Integra 31.6 mm adjustable SP, internal routing
- ▾ SDG Circuit
- ▾ XS/S/M/L/XL

SLAMR X 5

27,5



- BLACK / GREY / DARKGREY
- ▾ SLAMR X AL
- ▾ Fox 34 Talas Performance 150-130 mm 15 mm
- ▾ Fox Float X Performance 3 Pos 150 mm
- ▾ GHOST AS-M04 35 mm
- ▾ GHOST Rizer 760 mm 35 mm
- ▾ Shimano XT 10-Speed Plus
- ▾ Shimano Deore
- ▾ Shimano SLX SL
- ▾ Shimano Deore 36-22
- ▾ Shimano CS-HG50 11-36
- ▾ Shimano Deore Disc 180 mm SMRT 64
- ▾ Schwalbe Nobby Nic Evo 2.25 / 2.35
- ▾ Black Jack Ready 25
- ▾ Shimano Deore 15 mm
- ▾ Shimano Deore 12 mm
- ▾ Kind Shock Cruzi 31.6 mm adjustable SP, internal routing
- ▾ SDG Circuit
- ▾ XS/S/M/L/XL

FRAMR

ENG

The newly crowned king of the AMR family is the most capable, battle ready of them all. We get more suspension travel out of the AMR platform frame by turning the lower shock mount. This changes the personality of what might otherwise be a cultivated trail bike and transforms it into a hard-charging enduro machine. Additionally, the components were carefully selected and tested in close cooperation with top enduro racers, and edgy RIOT-styling combined with proven four-bar linkage will soon make the FR AMR a favorite of enduro riders everywhere.

GER

Eine Wendung mit überraschender Wirkung: Wir haben beim neuen FR AMR die untere Dämpfereufhängung gedreht. Der Effekt: Die bewährte und optimierte Viergelenk-Hinterbaukonstruktion stellt uns mehr Federweg zur Verfügung. Was bislang ein ohnehin schon potentes All Mountain-bike war, ist nun eine reinrassige Enduro-Maschine. Alle Komponenten wurden in Zusammenarbeit mit Enduro-Racern ausgewählt und getestet. Das Ergebnis ist ein Bike, das seinen Fahrer zu Bestzeiten ermutigt und es ihm erlaubt, die Stages zu dominieren.



- RED / BLACK
- FR AMR LC AL
- Rock Shox Pike RCT3 Solo Air 160 mm 15 DR
- Rock Shox Monarch Plus RC3 Debon Air 160 mm
- Race Face Atlas 35 mm
- Race Face Atlas 800 mm 35 mm
- Sram XX1 11-Speed
- Sram XX1 SL
- Race Face Next SL 32
- Sram XG-1199 10-42
- Sram Guide RS Disc 200/180 mm
- Schwalbe Nobby Nic 2.35
- Easton ARC 27
- GHOST Light 15 mm
- GHOST Light 12 mm
- Rock Shox Reverb Stealth 31.6 mm adjustable SP, internal routing
- SDG Circuit
- XS/S/M/L/XL



LC FRAMR 10

27,5"

- ORANGE / BLACK
- FR AMR LC AL
- Fox 36 Float Performance Elite 160 mm 15 DR
- Fox Float X Performance 160 mm
- Race Face Atlas 35 mm
- Race Face Atlas 800 mm 35 mm
- Shimano XT 11-Speed
- Shimano XT SL
- Race Face Turbine 32
- Shimano XT 11-42
- Shimano XT 203/180 mm SMRT 86
- Schwalbe Nobby Nic 2.35
- Easton ARC 27
- GHOST Light 15 mm
- GHOST Light 12 mm
- Kind Shock LEV Integra 31.6 mm adjustable SP, internal routing
- SDG Circuit
- XS/S/M/L/XL



LC FRAMR 8

27,5"

FRAMR 7

27,5



- GREEN / BLACK
- ▲ FRAMR AL
- ▲ Fox 36 Float Performance 160 mm 15 OR ▼
- ▲ Fox Float X Performance 160 mm ▼
- ▲ GHOST AS-GH 4 35 mm
- ▲ GHOST Rizer Light 780 mm 35 mm
- Shimano XT 11-Speed ▼
- Shimano XT SL ▼
- Race Face Turbine 32 ▼
- Shimano XT 11-42 ▼
- Shimano SLX Disc 203/180 SMRT 86 ▼
- Schwalbe Nobby Nic 2.35
- Easton ARC 27 ▼
- GHOST Light 15 mm ▼
- GHOST Light 12 mm ▼
- Kind Shock LEV Integra 31.6 mm adjustable SP, internal routing
- SDG Circuit
- XS/S/M/L/XL

AMR

ENG

This is a staple all rounder that carries with it a classic distinction. Its 29" wheels and lightweight carbon fiber frame make it ideal for battling big mountain marathons, yet it is equally confident tackling tight, technical races on the weekend as our professional XC team will attest. While it might sound like just a race weapon, don't be fooled, because with 130 mm of perfectly tuned suspension travel, the AMR offers as much fun as efficiency.

GER

Dieser zuverlässige Allrounder mit seinen 29-Zoll-Laufrädern und einem leichten Carbonrahmen ist ideal, um lange, harte Marathons in Angriff zu nehmen. Gleichzeitig kann man damit auch auf engen, technischen Strecken schnelle Zeiten fahren – unser Cross-Country-Team wird dir das gerne bestätigen. Was auf dem Papier nach einer reinrassigen Rennmaschine klingt, bringt in der Praxis dank der perfekt abgestimmten 130 Millimeter Hinterbaufederung extrem viel Spaß.

FRAMR 5

27,5



- BLUE / BLACK
- ▲ FRAMR AL
- ▲ Rock Shox Pike RC Solo Air 160 mm 15 OR
- ▲ Rock Shox Monarch Plus R Debon Air 160 mm
- ▲ GHOST AS-GH 4 35 mm
- ▲ GHOST Rizer Light 780 mm 35 mm
- ▲ Shimano ZEE 10-Speed
- ▲ Shimano Deore SL
- ▲ Race Face Affect 32
- ▲ Shimano CS-H650-10 11-36
- ▲ Shimano Deore Disc 203/180 mm SMRT 64
- Schwalbe Nobby Nic 2.35
- Black Jack Ready 25
- Shimano Deore 15 mm
- Shimano Deore 12 mm
- Kind Shock LEV Integra 31.6 mm adjustable SP, internal routing
- SDG Circuit
- XS/S/M/L/XL

- BLACK / BLACK
- ▲ AMR 29 Carbon / Alloy
- ▲ Fox 32 Float Factory Kashima 130 mm 15 mm ▼
- ▲ Fox Float DPS Factory Kashima 3 Pos 120 mm ▼
- ▲ Race Face Turbine 35 mm ▼
- ▲ Race Face Next Carbon 740 mm 35 mm ▼
- ▲ Shimano XTR 11-Speed Plus ▼
- ▲ Shimano XTR ▼
- ▲ Shimano XTR ▼
- ▲ Shimano XTR 36-26 ▼
- ▲ Shimano XTR 11-40 ▼
- ▲ Shimano XTR Disc Trail 180 mm SMRT 86 ▼
- ▲ Schwalbe Nobby Nic / Rocket Ron 2.25 ▼
- ▲ Race Face Affect Wheelset
- ▲ Race Face Affect 15 mm
- ▲ Race Face Affect 12 mm
- ▲ Kind Shock Integra 31.6 mm adjustable SP, internal routing
- ▲ Selle Italia SLR ▼
- XS/S/M/L/XL

LC AMR 9

29"



AMR 8

29"



- RED / BLACK
- AMR 29 Carbon / Alloy
- ▲ Fox 32 Float Performance 130 mm 15 mm
- ▲ Fox Float DPS Performance 3 Pos 120 mm
- ▲ GHOST AS-M01 31.8 mm
- ▲ GHOST Low Rizer Light 740 mm 31.8
- ▲ Shimano XT 11-Speed Plus
- ▲ Shimano XT
- ▲ Shimano XT
- ▲ Shimano XT 36-26
- ▲ Shimano XT 11-42
- ▲ Shimano XT Disc 180 mm SMRT 56
- ▲ Schwalbe Nobby Nic 2.25
- ▲ Race Face Affect Wheelset
- ▲ Race Face Affect 15 mm
- ▲ Race Face Affect 12 mm
- ▲ Kind Shock Integra 31.6 mm adjustable SP, internal routing
- ▲ GHOST VL 1353 SL
- ▲ XS/S/M/L/XL

AMR 4

29"



- BLACK / GREEN
- AMR 29 Alloy
- ▲ Rock Shox Revelation RL Solo Air 130 mm 15 mm
- ▲ X-Fusion 02 RL 120 mm
- ▲ GHOST AS-M01 31.8 mm
- ▲ GHOST Low Rizer Light 740 mm 31.8 mm
- ▲ Shimano XT 11-Speed Plus
- ▲ Shimano XT
- ▲ Shimano XT
- ▲ Shimano FC-MT 700 36-26
- ▲ Shimano XT 11-42
- ▲ Shimano Deore Disc 180 mm SMRT 64
- ▲ Schwalbe Nobby Nic 2.25
- ▲ Rigida Rival 21
- ▲ Shimano Deore 15 mm
- ▲ Shimano Deore 12 mm
- ▲ Kind Shock Cruxi 31.6 mm adjustable SP, internal routing
- ▲ GHOST VL 1353 SL
- ▲ XS/S/M/L/XL

AMR 6

29"



- BLACK / RED
- ▲ AMR 29 Alloy
- ▲ Fox 32 Float Performance 130 mm 15 mm
- ▲ Fox Float DPS Performance 3 Pos 120 mm
- ▲ GHOST AS-M01 31.8 mm
- ▲ GHOST Low Rizer Light 740 mm 31.8 mm
- ▲ Shimano XT 11-Speed Plus
- ▲ Shimano XT
- ▲ Shimano XT
- ▲ Shimano XT 36-26
- ▲ Shimano XT 11-42
- ▲ Shimano XT Disc 180 mm SMRT 56
- ▲ Schwalbe Nobby Nic 2.25
- ▲ Race Face Affect Wheelset
- ▲ Race Face Affect 15 mm
- ▲ Race Face Affect 12 mm
- ▲ Kind Shock Integra 31.6 mm adjustable SP, internal routing
- ▲ GHOST VL 1353 SL
- ▲ XS/S/M/L/XL

AMR 2

29"



- BLACK / BLUE
- AMR 29 Alloy
- ▲ Rock Shox Sektor Solo Air 130 mm 15 mm
- ▲ X-Fusion 02 RL 120 mm
- ▲ GHOST AS-M01 31.8 mm
- ▲ GHOST Low Rizer Light 740 mm 31.8 mm
- ▲ Shimano XT 10-Speed Plus
- ▲ Shimano Deore
- ▲ Shimano Deore
- ▲ Shimano Deore 36-22
- ▲ Shimano CS-HG50 11-36
- ▲ Shimano Deore Disc 180 mm SMRT 64
- ▲ Schwalbe Rocket Ron 2.25
- ▲ Rigida Rival 21
- ▲ Shimano Deore 15 mm
- ▲ Shimano Deore 12 mm
- ▲ GHOST Light DC 1 31.6 mm
- ▲ GHOST VL 1353 SL
- ▲ XS/S/M/L/XL

KATO FS

ENG

This is the entry to the world of true mountain biking. The Kato FS is redesigned with inspiration from our higher end full suspension bikes, but at the price of a hardtail. Through advanced FEM calculations we reduced its weight while increasing stiffness. The improved suspension kinematics equal the performance of our top models, and high quality bearings were added for near maintenance free durability. The optimized geometry is beginner friendly which is one of the reasons we like to call this bike "the smile maker". Another reason? The price.

GER

Unser Einstieg in die Welt des vollgefederten Mountainbikens: Das Kato FS wurde vor dem Hintergrund unserer Erfahrung mit High-End-Fullys redesigned – aber mit einem Preisetikett versehen, das man eher im Hardtail-Segment vermuten würde. Komplexe FEM-Berechnungen haben es uns erlaubt, das Gewicht zu senken und die Steifigkeit dabei zu erhöhen. Die optimierte Dämpfungs-Kinematik steht der Leistung unserer Topmodelle in nichts nach und die hochwertigen Lager garantieren eine lange Haltbarkeit bei minimaler Wartung. Dieses Bike wird dir gleich zweimal ein Lächeln beschieren: zum einen beim Kauf, denn der Preis gibt reichlich Anlass zur Freude. Zum anderen draußen auf dem Trail, denn die verbesserte Geometrie beschert auch Anfängern schnelle Erfolgsergebnisse.



- RED / BLACK
- ▾ Kato FS Alloy
- ▮ Fox 32 Float Performance 130 mm
- ▮ Fox Float Performance 3 Pos 130 mm ▼
- ▮ GHOST AS GH2 31.8 mm
- ▮ GHOST Low Rizer Light 720 mm 31.8 mm
- ▮ Shimano XT 11-Speed Plus ▼
- ▮ Shimano XT ▼
- ▮ Shimano XT ▼
- ▮ Shimano XT 36-26 ▼
- ▮ Shimano XT 11-42 ▼
- ▮ Shimano Deore Disc 180 mm ▼
- ▮ Michelin Wild Grip'R 2.25 ▼
- ▮ Rigida Rival 21
- ▮ Shimano Deore QR
- ▮ Shimano Deore QR
- ▮ GHOST Light DC 1 31.6 mm
- ▮ GHOST VL-1353
- ▮ XS/S/M/L/XL



KATO FS 5

27,5

- BLACK / GREY
- ▾ Kato FS Alloy
- ▮ Fox 32 Float Performance 130 mm
- ▮ Fox Float Performance 3 Pos 130 mm ▼
- ▮ GHOST AS GH2 31.8 mm
- ▮ GHOST Low Rizer Light 720 mm 31.8 mm
- ▮ Shimano XT 11-Speed Plus ▼
- ▮ Shimano XT ▼
- ▮ Shimano XT ▼
- ▮ Shimano XT 36-26 ▼
- ▮ Shimano XT 11-42 ▼
- ▮ Shimano Deore Disc 180 mm ▼
- ▮ Michelin Wild Grip'R 2.25 ▼
- ▮ Rigida Rival 21
- ▮ Shimano Deore QR
- ▮ Shimano Deore QR
- ▮ GHOST Light DC 1 31.6 mm
- ▮ GHOST VL-1353
- ▮ XS/S/M/L/XL



KATO FS 5

27,5

KATO FS 3

27,5"



●	BLACK / GREEN
↗	Kato FS Alloy
h	Fox 32 Float Performance 130 mm
▲	X-Fusion 02 RL 130 mm
■	GHOST AS GH2 31.8 mm
—	GHOST Low Rizer Light 720 mm 31.8 mm
▲	Shimano XT 10-Speed Plus
▲	Shimano Deore
▲	Shimano Deore
▲	Shimano Deore 40-30-22
▲	Shimano CS-HG 50 11-36
▲	Shimano 396 Disc 180 mm
▲	Michelin Wild Grip'R 2.25
☾	Rigida Rival 21
+	Shimano Deore QR
+	Shimano Deore QR
⌘	GHOST Light DC 1 31.6 mm
▲	GHOST VL-1353
—	XS/S/M/L/XL

LECTOR

ENG

By integrating the requests of our team riders with the demands of our engineers, we've created our most spectacular hardtail ever. The integration of angular shapes and smooth transitions provides additional torsional stiffness, improved stress distribution and a distinctive look. All cables enter the frame at the head tube and reemerge appropriately, while the port under the bottom bracket serves both to protect the frame and to provide easy access for maintenance. The chain stay is protected from damage by a specially formed plastic sheath.

The disconnect brake mount, an innovative technical feature already proven on the GHOST RIOT, has been redesigned for use on the LECTOR. In addition to a point on the seat stay, it is mounted directly to the X12 thru-axle and thus maintains perfect alignment with respect to the brake rotor, with the added benefit of helping to transfer braking forces into the axle instead of the carbon of the frame.

The geometry has been refined with one goal in mind, better agility and more precise handling. The 31.6 mm seat tube diameter also gives you the option of using a dropper seat post, as some on the World Cup now do, letting you ride even more aggressively in technical terrain. LECTOR is back and killing it.

GER

Wir haben die Wünsche unserer Teamfahrer mit den Ansprüchen unserer Ingenieure vereint. Das Ergebnis: das spektakulärste Hardtail aller Zeiten. Kantige Formen und sanfte Übergänge sorgen nicht nur für ein unverwechselbares Aussehen, sondern auch für mehr Steifigkeit und eine bessere Lastenverteilung. Sämtliche Leitungen werden am Steuerrohr in den Rahmen eingeführt und kommen bedarfsgerecht wieder zum Vorschein. Das Unterrohr, die Sitzstreben und sogar der Tretlagerbereich verbergen die Züge und Leitungen und schützen sie so vor äußeren Einflüssen. Die Disconnect Brake Mount Bremsenaufnahme ist eine innovative technische Lösung mit herausragendem Design, die sich bereits beim GHOST RIOT bewährt hat und noch einmal optimiert wurde.

Die Hinterradbremse ist bei den LECTOR ULC Modellen direkt mit dem X12 Steckachssystem verbunden und schützt den Rahmen vor thermischen und mechanischen Belastungen bei gleichzeitig geringerem Gesamtgewicht.

Die Geometrie wurde ebenfalls verfeinert. Kürzere Steuerrohre und Kettenstreben sorgen für mehr Agilität und direkteres Fahrverhalten. Im Weltcup bewährt: 31,6 Millimeter Sitzrohrdurchmesser erlauben den Einsatz von Teleskopsattelstützen und damit noch aggressivere Positionen und Fahrmanöver. Das LECTOR ist zurück – und es ist schneller als je zuvor.



reddot award 2015
winner



KATO FS 2

27,5"



●	BLACK / BLUE
↗	Kato FS Alloy
▲	RST Aerial Air LO 130 mm
▲	X-Fusion 02 RL 130 mm
■	GHOST AS GH2 31.8 mm
—	GHOST Low Rizer Light 720 mm 31.8 mm
▲	Shimano Deore 10-Speed Plus
▲	Shimano Deore
▲	Shimano Deore
▲	Shimano 523 40-30-22
▲	Shimano CS-HG 50 11-36
▲	Tektro ACC 001 180 mm
▲	Schwalbe Smart Sam 2.25
☾	Rigida Rival 19
+	GHOST Disc QR
+	GHOST Disc QR
⌘	GHOST Light DC 1 31.6 mm
▲	GHOST VL-1353
—	XS/S/M/L/XL

●	BLACK / WHITE
↗	Lector 29 Carbon ULC
h	Rock Shox RS 1 100 mm
■	Tune Geiles Teil 31.8 mm
—	AX Lightness Poseidon 740 mm 31.8 mm
▲	Sram XX1 11-Speed
▲	Sram XX1 SL
▲	Sram XX1 32
▲	Sram XG 1199 10-42
▲	Sram XX Disc 180/160 mm
▲	Schwalbe Thunder Burt Evo 2.25
☾	AX Lightness Carbon
+	Tune Prince 15 mm
+	Tune Princess 12 mm
⌘	AX Lightness Europa Selection 31.6 mm
▲	Tune Komm Vor
—	XS/S/M/L/XL

LECTOR WORLD CUP

29"



HARDTAIL

ULC **LECTOR 10**

29"



- DARKRED/BLACK
- ▾ Lector 29 Carbon ULC
- ▲ Fox 32 Float Factory Kashima Remote 100 mm 15 mm
- ▲ Race Face Turbine 31.8 mm
- ▲ Race Face Next Carbon 720 mm 31.8 mm
- Shimano XTR 11-Speed DIZ
- Shimano XTR DIZ
- Shimano XTR SL DIZ
- ▲ Shimano XTR 36-26
- ▲ Shimano XTR 11-40
- ▲ Shimano XTR CC Disc 180/160 mm SMRT 86
- ▲ Schwalbe Rocket Ron/Thunder Burt Evo 2.25
- ▲ Tune
- ▲ Tune King 15 mm
- ▲ Tune Kong 12 mm
- ▲ GHOST SL Carbon 31.6 mm
- ▲ SDG Circuit
- XS/S/M/L/XL

LC **LECTOR 8**

29"



- BLACK/WHITE
- ▲ Lector 29 Carbon LC
- ▲ Rock Shox SID RL 100 mm Oneloc 15 mm
- ▲ Race Face Turbine 31.8 mm
- Race Face Next Carbon 720 mm 31.8 mm
- ▲ Sram X01 11-Speed ▼
- - ▼
- ▲ Sram X01 SL ▼
- ▲ Sram GX1 1400 30
- ▲ Sram XG 1180 10-42
- ▲ Sram Guide RS Disc 180/160 mm ▼
- ▲ Schwalbe Rocket Ron/Thunder Burt Evo 2.25
- ▲ Race Face Affect Wheelset
- ▲ Race Face Affect Wheelset 15 mm
- ▲ Race Face Affect Wheelset 12 mm
- ▲ GHOST SL Carbon 31.6 mm
- ▲ SDG Circuit
- XS/S/M/L/XL

ULC **LECTOR 9**

29"



- DARKRED/BLACK
- ▾ Lector 29 Carbon ULC ▼
- ▲ Fox 32 Float Factory Kashima Remote 100 mm 15 mm ▼
- ▲ Race Face Turbine 31.8 mm
- Race Face Next Carbon 720 mm 31.8 mm
- Shimano XTR 11-Speed ▼
- Shimano XTR ▼
- Shimano XTR SL ▼
- ▲ Shimano XTR 36-26 ▼
- ▲ Shimano XTR 11-40 ▼
- ▲ Shimano XTR CC Disc 180/160 mm SMRT 86 ▼
- ▲ Schwalbe Rocket Ron/Thunder Burt Evo 2.25 ▼
- ▲ Tune ▼
- ▲ Tune King 15 mm ▼
- ▲ Tune Kong 12 mm ▼
- ▲ GHOST SL Carbon 31.6 mm
- ▲ SDG Circuit
- XS/S/M/L/XL

LC **LECTOR 7**

29"



- ORANGE/BLACK
- ▾ Lector 29 Carbon LC
- ▲ Rock Shox SID RL 100 mm Oneloc 15 mm ▼
- ▲ Race Face Turbine 31.8 mm ▼
- Race Face Next Carbon 720 mm 31.8 mm ▼
- ▲ Shimano XT 11-Speed Plus
- ▲ Shimano XT
- ▲ Shimano XT SL
- ▲ Shimano XT 36-26
- ▲ Shimano XT 11-40
- ▲ Shimano XT Disc 180/160 mm SMRT 86 ▼
- ▲ Schwalbe Rocket Ron/Thunder Burt Evo 2.25 ▼
- ▲ Race Face Affect Wheelset ▼
- ▲ Race Face Affect Wheelset 15 mm ▼
- ▲ Race Face Affect Wheelset 12 mm ▼
- ▲ GHOST SL Carbon 31.6 mm
- ▲ SDG Circuit
- XS/S/M/L/XL

LECTOR 6

29"



- BLACK/WHITE/GREY
- ✂ Lector 29 Carbon LC
- ▲ Fox 32 Float Performance Remote 100 mm 15 mm ▼
- ▲ GHOST M01 31.8 mm
- ▲ GHOST Flat Light 720 mm 31.8 mm
- Shimano XT 11-Speed Plus
- Shimano XT
- Shimano XT SL
- Shimano XT 36-26
- Shimano XT 11-40
- ▲ Shimano XT Disc 180/160 mm SMRT 64 ▼
- ▲ Schwalbe Rocket Ron Evo 2.25
- ▲ Rigida Rival 21
- ▲ Shimano XT 15 mm ▼
- ▲ Shimano XT 12 mm ▼
- ▲ GHOST SL 719 31.6 mm
- ▲ SDG Circuit
- XS/S/M/L/XL

LECTOR 5

29"



- BLACK/BLACK
- ✂ Lector 29 Carbon LC
- ▲ Rock Shox Reba RL Solo Air 100 mm Oneloc 15 mm ▼
- ▲ GHOST M01 31.8 mm
- GHOST Flat Light 720 mm 31.8 mm
- Sram GX 11-Speed
- -
- Sram GX SL
- Sram GX 1 1000 30
- Sram GX 1150 10-42
- ▲ Sram Guide R Disc 180/160 mm ▼
- ▲ Schwalbe Rocket Ron Evo 2.25
- ▲ Rigida Rival 21
- ▲ GHOST SL Disc 15 mm ▼
- ▲ GHOST SL Disc 12 mm ▼
- ▲ GHOST SL 719 31.6 mm
- ▲ SDG Circuit
- XS/S/M/L/XL

LECTOR 6

29"



- GREEN/DARKGREEN/BLACK
- ✂ Lector 29 Carbon LC
- ▲ Fox 32 Float Performance Remote 100 mm 15 mm ▼
- ▲ GHOST M01 31.8 mm
- ▲ GHOST Flat Light 720 mm 31.8 mm
- Shimano XT 11-Speed Plus
- Shimano XT
- Shimano XT SL
- Shimano XT 36-26
- Shimano XT 11-40
- ▲ Shimano XT Disc 180/160 mm SMRT 64 ▼
- ▲ Schwalbe Rocket Ron Evo 2.25
- ▲ Rigida Rival 21
- ▲ Shimano XT 15 mm ▼
- ▲ Shimano XT 12 mm ▼
- ▲ GHOST SL 719 31.6 mm
- ▲ SDG Circuit
- XS/S/M/L/XL

LECTOR 3

29"



- DARKBLUE/BLUE/WHITE
- ✂ Lector 29 Carbon LC
- ▲ Rock Shox Recon Gold RL 100 mm Oneloc 15 mm
- ▲ GHOST M01 31.8 mm
- GHOST Flat Light 720 mm 31.8 mm
- Shimano XT 11-Speed Plus
- Shimano XT
- Shimano XT SL
- Shimano XT 36-26
- Shimano XT 11-40
- ▲ Shimano Deore Disc 180/160 mm SM-RT 20
- ▲ Schwalbe Rocket Ron Evo 2.25
- ▲ Rigida Rival 21
- ▲ Shimano Deore 15 mm
- ▲ Shimano Deore 12 mm
- ▲ GHOST SL 719 31.6 mm
- ▲ SDG Circuit
- XS/S/M/L/XL

ASKET

ENG

The ASKET name comes from the Ancient Greek word "áskēsis", meaning exercise or training. This bike is a fusion of a minimalistic hardtail approach with some of the capabilities of an agile, full suspension trail bike. We even had to create a completely new category for it. We call it "Hardtail". A trail cockpit, 130 mm travel fork with 34 mm stanchions and internally routed dropper seatpost are just some of the defining features of this special bike. Riding it means accepting the challenges on trails that are not always ideally suited for just any hardtail. But if you're the rider, ASKET will allow you to reap the rewards.

GER

Es ist ein asketisches Bike – und das nicht nur dem Namen nach. Es ist ein auf das Wesentliche reduziertes Hardtail, das speziell für den härtesten Traileinsatz entwickelt wurde. Wir mussten sogar eine neue Kategorie dafür kreieren: wir nennen sie „Hardtail“. Trailcockpit, 130 mm Federgabel mit 34 mm Standrohren und Variostütze mit innenliegender Zugführung sind nur einige der vielen Highlights dieses besonderen Bikes. Es zu fahren, bedeutet Herausforderungen anzunehmen, auf Trails, bei denen man sonst vielleicht nicht unbedingt zu einem Hardtail greifen würde. Aber wer es tut, wird vom ASKET mehr als belohnt.



- BLACK / WHITE / GREY
- Asket 27.5 Carbon
- h Fox 34 Float Factory Kashima 130 mm 15 mm ▼
- ☛ Race Face Turbine 35 mm
- ☛ Race Face Next Carbon 760 mm 35 mm ▼
- ☛ Shimano XTR 11-Speed Plus
- ☛ -
- ☛ Shimano XT SL
- ☛ Race Face Next 32 ▼
- ☛ Shimano XT 11-42 ●
- ☛ Shimano XT Disc Fin 180/160 mm SMRT 86 ●
- ☛ Schwalbe Nobby Nic Evo 2.35
- ☛ GHOST Carbon Wheelset 24 ▼
- ☛ GHOST SL 15 mm ▼
- ☛ GHOST SL 12 mm ▼
- ☛ Kind Shock Integra 31.6 mm adjustable SP, internal routing ▼
- ☛ SDG Circuit SL
- ☛ XS/S/M/L/XL



LC ASKET 9

27,5

- BLACK / WHITE / RED
- Asket 27.5 Carbon
- ▲ h Fox 34 Float Performance Elite 130 mm 15 mm ▼
- ☛ Race Face Turbine 35 mm ▼
- ▲ ☛ Race Face Turbine 760 mm 35 mm ▼
- ☛ Sram X01 11-Speed
- ☛ -
- ☛ Sram X01 SL
- ▲ ☛ Sram GX1 1400 30
- ☛ Sram XG 1180 10-42 ●
- ☛ Sram Guide RS Disc 180/160 mm ●
- ☛ Schwalbe Nobby Nic Evo 2.35
- ▲ ☛ Easton ARC 24 ▼
- ▲ ☛ GHOST Light 15 mm ▼
- ▲ ☛ GHOST Light 12 mm ▼
- ▲ ☛ Rock Shox Reverb Stealth 31.6 mm adjustable SP, internal routing ▼
- ☛ SDG Circuit SL
- ☛ XS/S/M/L/XL



LC ASKET 8

27,5

LC **ASKET 5**

27,5



- BLACK/WHITE/GREEN
- Asket 27.5 Carbon
- ▲ Fox 34 Float Performance 130 mm 15 mm
- ▲ Race Face Ride 35 mm
- ▲ Race Face Rizer Ride 760 mm 35 mm
- Shimano XT 11-Speed Plus ▼
- Shimano XT ▼
- Shimano XT ▼
- Shimano XT 36-26 ▼
- Shimano XT 11-40 ▼
- Shimano XT Disc 180/160 mm SMRT 64 ▼
- Schwalbe Nobby Nic Evo 2.35
- ▲ Black Jack Ready 25
- ▲ Shimano XT 15 mm ▼
- ▲ Shimano XT 12 mm ▼
- ▲ Kind Shock Cruxi 31.6 mm adjustable SP, internal routing
- ▲ SDG Circuit
- XS/S/M/L/XL

LC **ASKET 3**

27,5



- BLACK/WHITE/BLUE
- Asket 27.5 Carbon
- ▲ Fox 34 Float Performance 130 mm 15 mm
- GHOST M04 35 mm
- GHOST Low Rizer Light 760 mm 35 mm
- ▲ Shimano XT 10-Speed Plus
- ▲ Shimano Deore
- ▲ Shimano Deore SL
- ▲ Shimano Deore 36-22
- ▲ Shimano CS-HG50 11-36
- ▲ Shimano Deore Disc 180/160 mm SMRT 64
- Schwalbe Nobby Nic Evo 2.35
- ▲ Black Jack Ready 25
- ▲ Shimano Deore 15 mm
- ▲ Shimano Deore 12 mm
- ▲ Kind Shock Cruxi 31.6 mm adjustable SP, internal routing
- ▲ SDG Circuit
- XS/S/M/L/XL

TACANA

ENG

The Tacana readies you to take on new challenges. A thoughtfully designed frame combined with 29" wheels and reliable components deliver smooth riding for your mid-week workout, and the proven geometry keeps you comfortable for your longer weekend adventures as well. So get ready to conquer that next climb, and then hold on as you enjoy all the freedom and flow of the single track on the way back down.

GER

Unser Tacana bringt dich dazu, neue Herausforderungen anzunehmen. Es überzeugt durch ein durchdachtes Rahmendesign mit ausgewogener Geometrie, 29-Zoll-Laufräder und zuverlässige Komponenten. Es ist ein Bike für die kurze Trainingssession genauso wie für das große Abenteuer am Wochenende – mit der bewährten Geometrie dieses Bikes ist alles möglich.



TACANA 7

29"



- RED / DARKRED / BLACK
- ▾ Tacana 29 Alloy
- ▾ Rock Shox 30 Gold Air RL 100 mm Poploc
- ▾ GHOST M01 31.8 mm
- ▾ GHOST Low Rizer 720 mm 31.8 mm
- ▾ Shimano XT 10-Speed
- ▾ Shimano Deore
- ▾ Shimano Deore SL
- ▾ Shimano Deore 40-30-22
- ▾ Shimano CS-HG50 11-36
- ▾ Shimano 396 Disc 180/160 mm
- ▾ Schwalbe Smart Sam 2.1
- ▾ Rigida Rival 21
- ▾ Shimano Deore QR
- ▾ Shimano Deore QR
- ▾ GHOST Light DC1 31.6 mm
- ▾ GHOST VL 1353
- ▾ XS/S/M/L/XL

TACANA 5

29"



- RED / DARKRED / BLACK
- ▾ Tacana 29 Alloy
- ▾ SR Suntour Raidon RL-R 100 mm
- ▾ GHOST M01 31.8 mm
- ▾ GHOST Low Rizer 720 mm 31.8 mm
- ▾ Shimano XT 10-Speed
- ▾ Shimano Deore
- ▾ Shimano Deore SL
- ▾ Shimano Deore 40-30-22
- ▾ Shimano CS-HG50 11-36
- ▾ Shimano 355 Disc 160 mm SMRT 20
- ▾ Michelin Country Race R 2.10
- ▾ Rigida Rival 21
- ▾ Shimano HB-RM 33 QR
- ▾ Shimano FH-RM 33 QR
- ▾ GHOST Light DC1 31.6 mm
- ▾ GHOST VL 1353
- ▾ XS/S/M/L/XL

TACANA 7

29"



- BLACK / RED / BLUE
- ▾ Tacana 29 Alloy
- ▾ Rock Shox 30 Gold Air RL 100 mm Poploc
- ▾ GHOST M01 31.8 mm
- ▾ GHOST Low Rizer 720 mm 31.8 mm
- ▾ Shimano XT 10-Speed
- ▾ Shimano Deore
- ▾ Shimano Deore SL
- ▾ Shimano Deore 40-30-22
- ▾ Shimano CS-HG50 11-36
- ▾ Shimano 396 Disc 180/160 mm
- ▾ Schwalbe Smart Sam 2.1
- ▾ Rigida Rival 21
- ▾ Shimano Deore QR
- ▾ Shimano Deore QR
- ▾ GHOST Light DC1 31.6 mm
- ▾ GHOST VL 1353
- ▾ XS/S/M/L/XL

TACANA 5

29"



- BLACK / GREEN / BLUE
- ▾ Tacana 29 Alloy
- ▾ SR Suntour Raidon RL-R 100 mm
- ▾ GHOST M01 31.8 mm
- ▾ GHOST Low Rizer 720 mm 31.8 mm
- ▾ Shimano XT 10-Speed
- ▾ Shimano Deore
- ▾ Shimano Deore SL
- ▾ Shimano Deore 40-30-22
- ▾ Shimano CS-HG50 11-36
- ▾ Shimano 355 Disc 160 mm SMRT 20
- ▾ Michelin Country Race R 2.10
- ▾ Rigida Rival 21
- ▾ Shimano HB-RM 33 QR
- ▾ Shimano FH-RM 33 QR
- ▾ GHOST Light DC1 31.6 mm
- ▾ GHOST VL 1353
- ▾ XS/S/M/L/XL

TACANA 4

29"



- BLACK / GREEN / BLUE
- ▾ Tacana 29 Alloy
- ▲ Rock Shox XC 30 100 mm Poploc ▼
- ▾ GHOST AS GH2 31.8 mm ▼
- ▾ GHOST Low Rizer 720 mm 31.8 mm ▼
- ▲ Shimano Deore 9-Speed ▼
- ▲ Shimano Acera ▼
- ▲ Shimano Alivio SL ▼
- ▲ Shimano Alivio 2 Pieces 40-30-22 ▼
- ▲ Shimano CS-HG200 11-34 ▼
- ▾ Shimano 355 Disc 160 mm SMRT 20 ▼
- ▾ Michelin Country Race R 2.10 ▼
- ▾ Rigida Rival 21 ▼
- ▾ Shimano HB-RM 33 QR ▼
- ▾ Shimano FH-RM 33 QR ▼
- ▾ GHOST Light DC1 31.6 mm ▼
- ▾ GHOST VL 3315 ▼
- ▾ XS / S / M / L / XL

TACANA 3

29"



- BLACK / GREEN / GREY
- ▾ Tacana 29 Alloy
- ▲ SR Suntour XCM RL 100 mm ▼
- ▾ GHOST AS GH2 31.8 mm ▼
- ▾ GHOST Low Rizer 720 mm 31.8 mm ▼
- ▲ Shimano Deore 9-Speed ▼
- ▲ Shimano FD-M370 ▼
- ▲ Shimano Altus SL ▼
- ▲ Shimano FC 371 44-32-22 ▼
- ▾ Shimano CS-HG200 11-34 ▼
- ▾ Shimano 355 Disc 160 mm SMRT 20 ▼
- ▾ Michelin Country Race R 2.10 ▼
- ▾ Rigida Rival 21 ▼
- ▾ Shimano HB-RM 33 QR ▼
- ▾ Shimano FH-RM 33 QR ▼
- ▾ GHOST Light DC1 31.6 mm ▼
- ▾ GHOST VL 3315 ▼
- ▾ XS / S / M / L / XL

TACANA 4

29"



- GREEN / DARKGREEN / BLACK
- ▾ Tacana 29 Alloy
- ▲ Rock Shox XC 30 100 mm Poploc ▼
- ▾ GHOST AS GH2 31.8 mm ▼
- ▾ GHOST Low Rizer 720 mm 31.8 mm ▼
- ▲ Shimano Deore 9-Speed ▼
- ▲ Shimano Acera ▼
- ▲ Shimano Alivio SL ▼
- ▲ Shimano Alivio 2 Pieces 40-30-22 ▼
- ▲ Shimano CS-HG200 11-34 ▼
- ▾ Shimano 355 Disc 160 mm SMRT 20 ▼
- ▾ Michelin Country Race R 2.10 ▼
- ▾ Rigida Rival 21 ▼
- ▾ Shimano HB-RM 33 QR ▼
- ▾ Shimano FH-RM 33 QR ▼
- ▾ GHOST Light DC1 31.6 mm ▼
- ▾ GHOST VL 3315 ▼
- ▾ XS / S / M / L / XL

TACANA 3

29"



- GREEN / DARKGREEN / BLACK
- ▾ Tacana 29 Alloy
- ▲ SR Suntour XCM RL 100 mm ▼
- ▾ GHOST AS GH2 31.8 mm ▼
- ▾ GHOST Low Rizer 720 mm 31.8 mm ▼
- ▲ Shimano Deore 9-Speed ▼
- ▲ Shimano FD-M370 ▼
- ▲ Shimano Altus SL ▼
- ▲ Shimano FC 371 44-32-22 ▼
- ▾ Shimano CS-HG200 11-34 ▼
- ▾ Shimano 355 Disc 160 mm SMRT 20 ▼
- ▾ Michelin Country Race R 2.10 ▼
- ▾ Rigida Rival 21 ▼
- ▾ Shimano HB-RM 33 QR ▼
- ▾ Shimano FH-RM 33 QR ▼
- ▾ GHOST Light DC1 31.6 mm ▼
- ▾ GHOST VL 3315 ▼
- ▾ XS / S / M / L / XL

TACANA 2

29"



- BLACK / GREEN / GREY
- ▾ Tacana 29 Alloy
- ▲ RST Blaze RL 100 mm ▼
- ▾ GHOST AS GH2 31.8 mm
- ▾ GHOST Low Rizer 720 mm 31.8 mm
- ▲ Shimano Acera 8-Speed ▼
- ▲ Shimano FD-M190
- ▲ Shimano SL-M310
- ▲ Shimano FC 171 42-34-24
- Shimano CS-HG200 12-32
- ▲ Tektro ACC 001 Disc 160 mm
- Michelin Country Race R 2.10
- ▲ Rigid Rival 19
- ▾ GHOST Disc Hub Light QR ▼
- ▾ GHOST Disc Hub Light QR ▼
- ▾ GHOST Light DC1 31.6 mm
- ▾ GHOST VL 3315
- ▾ XS/S/M/L/XL

TACANA 1

29"



- BLACK / RED / GREY
- ▾ Tacana 29 Alloy
- ▲ RST Blaze ML 100 mm
- ▾ GHOST AS GH2 31.8 mm
- ▾ GHOST Low Rizer 720 mm 31.8 mm
- ▲ Shimano Altus 8-Speed
- ▲ Shimano FD-M190
- ▲ Shimano SL-M310
- ▲ Shimano FC 171 42-34-24
- Shimano CS-HG200 12-32
- ▲ Tektro ACC 001 Disc 160 mm
- Michelin Country Race R 2.10
- ▲ Rigid Rival 19
- ▾ GHOST Disc Hub QR
- ▾ GHOST Disc Hub QR
- ▾ GHOST Light DC1 31.6 mm
- ▾ GHOST VL 3315
- ▾ XS/S/M/L/XL

TACANA 2

29"



- BLUE / DARKBLUE / BLACK
- ▾ Tacana 29 Alloy
- ▲ RST Blaze RL 100 mm ▼
- ▾ GHOST AS GH2 31.8 mm
- ▾ GHOST Low Rizer 720 mm 31.8 mm
- ▲ Shimano Acera 8-Speed ▼
- ▲ Shimano FD-M190
- ▲ Shimano SL-M310
- ▲ Shimano FC 171 42-34-24
- Shimano CS-HG200 12-32
- ▲ Tektro ACC 001 Disc 160 mm
- Michelin Country Race R 2.10
- ▲ Rigid Rival 19
- ▾ GHOST Disc Hub Light QR ▼
- ▾ GHOST Disc Hub Light QR ▼
- ▾ GHOST Light DC1 31.6 mm
- ▾ GHOST VL 3315
- ▾ XS/S/M/L/XL

TACANA 1

29"



- BLUE / DARKBLUE / BLACK
- ▾ Tacana 29 Alloy
- ▲ RST Blaze ML 100 mm
- ▾ GHOST AS GH2 31.8 mm
- ▾ GHOST Low Rizer 720 mm 31.8 mm
- ▲ Shimano Altus 8-Speed
- ▲ Shimano FD-M190
- ▲ Shimano SL-M310
- ▲ Shimano FC 171 42-34-24
- Shimano CS-HG200 12-32
- ▲ Tektro ACC 001 Disc 160 mm
- Michelin Country Race R 2.10
- ▲ Rigid Rival 19
- ▾ GHOST Disc Hub QR
- ▾ GHOST Disc Hub QR
- ▾ GHOST Light DC1 31.6 mm
- ▾ GHOST VL 3315
- ▾ XS/S/M/L/XL

TACANA X

ENG

What is so "X" about this one? It is the very element that defines the bike, the frame. Even lighter, even sharper. The frame, built from a completely new tube set, was developed with one goal in mind, creating the stiffest and lightest frame in its class. The anodized finish not only gives the frame a unique look, it also provides Xtra weight savings. The shorter, more agile geometry, Xtended action radius and the option to add an internally routed dropper seatpost will give you added confidence when the terrain gets Xtreme. Is that what you Xpected?

GER

Das eXtra an diesem Bike ist sein Rahmen. Mit dem komplett neuen Rohrsatz ist es uns gelungen, den steifsten und leichtesten Rahmen seiner Klasse zu bauen. Technische eXtras wie Variostützen-Vorbereitung oder die anodisierten Oberflächen verleihen ihm nicht nur einen einzigartigen Look sondern sparen auch Gewicht. Und wenn das Gelände dein Fahrkönnen bis zum Äußersten fordert, gibt dir die kürzere, wendigere Geometrie stets das nötige Selbstvertrauen.



- BLACK / GREY
- ▾ Tacana 29 Alloy SL
- ▮ Rock Shox Reba RL Solo Air 100 mm Oneloc
- ▮ GHOST GH-1 31.8 mm
- ▮ GHOST Low Rizer 720 mm 31.8 mm
- ▮ Shimano XT 11-Speed Plus
- ▮ Shimano XT
- ▮ Shimano XT SL
- ▮ Shimano XT 36-26
- ▮ Shimano XT 11-42
- ▮ Shimano XT Disc 180 SMRT 66
- ▮ Schwalbe Rocket Ron 2.25
- ▮ Race Face Affect Wheelset
- ▮ Race Face Affect Wheelset DR
- ▮ Race Face Affect Wheelset DR
- ▮ GHOST SL 719 31.6 mm
- ▮ GHOST VL 1353 SL
- ▮ XS/S/M/L/XL

TACANA X 8

29"



- RED / BLACK
- ▾ Tacana 29 Alloy SL
- ▮ Rock Shox Reba RL Solo Air 100 mm Oneloc
- ▮ GHOST GH-1 31.8 mm
- ▮ GHOST Low Rizer 720 mm 31.8 mm
- ▮ Shimano XT 10-Speed Plus
- ▮ Shimano Deore
- ▮ Shimano Deore SL
- ▮ Shimano SLX 40-30-22
- ▮ Shimano CS-HG50 11-36
- ▮ Shimano Deore Disc 180 mm
- ▮ Schwalbe Rocket Ron 2.25
- ▮ Rigid Rival 21
- ▮ Shimano Deore QR
- ▮ Shimano Deore QR
- ▮ GHOST SL 719 31.6 mm
- ▮ GHOST VL 1353 SL
- ▮ XS/S/M/L/XL

TACANA X 6

29"



HARDTAIL

KATO

ENG

The Kato has been especially designed for you to enjoy riding trails solo and with your friends. The short chain stays and 27.5" wheels make it extremely quick and agile. For uncompromised safety, we offer disc brakes throughout the model group, and all components were carefully selected in order to create a bike as maintenance-free as possible, so all you have to do is go ride and have fun.

GER

Das Kato wurde entwickelt, um Spaß zu haben – ob alleine auf den Trails oder gemeinsam mit Freunden. Die kurze Kettenstange und die 27,5-Zoll-Räder machen dieses Bike extrem schnell und wendig. Für kompromisslose Sicherheit finden sich an allen Modellen Scheibenbremsen. Außerdem wurden alle Komponenten so ausgewählt, dass sie besonders wartungsarm sind, ganz nach dem Motto „fahren statt schrauben“.

- RED / DARKRED / BLACK
- 🔧 Kato 27.5 Alloy
- 🏠 Rock Shox 30 Gold Solo Air RL 120 mm ▼
- 🔧 GHOST M01 31.8 mm
- 📏 GHOST Low Rizer 720 mm 31.8 mm
- 🔧 Shimano XT 10-Speed
- 🔧 Shimano Deore
- 🔧 Shimano Deore SL
- 🔧 Shimano Deore 40-30-22
- 🔧 Shimano CS-HG50 11-36
- 🔧 Shimano 396 Disc 180/160 mm ▼
- 🔧 Schwalbe Smart Sam 2.25
- 🌙 Rigida Rival 21
- 🔧 Shimano Deore DR ▼
- 🔧 Shimano Deore DR ▼
- 🔧 GHOST Light DC1 31.6 mm
- 🔧 GHOST VL 1353
- 📏 XS/S/M/L/XL



KATO 7

27,5

KATO 7

27,5

- BLACK / RED / BLUE
- 🔧 Kato 27.5 Alloy
- 🏠 Rock Shox 30 Gold Solo Air RL 120 mm ▼
- 🔧 GHOST M01 31.8 mm
- 📏 GHOST Low Rizer 720 mm 31.8 mm
- 🔧 Shimano XT 10-Speed
- 🔧 Shimano Deore
- 🔧 Shimano Deore SL
- 🔧 Shimano Deore 40-30-22
- 🔧 Shimano CS-HG50 11-36
- 🔧 Shimano 396 Disc 180/160 mm ▼
- 🔧 Schwalbe Smart Sam 2.25
- 🌙 Rigida Rival 21
- 🔧 Shimano Deore DR ▼
- 🔧 Shimano Deore DR ▼
- 🔧 GHOST Light DC1 31.6 mm
- 🔧 GHOST VL 1353
- 📏 XS/S/M/L/XL



- BLACK / GREEN / BLUE
- 🔧 Kato 27.5 Alloy
- 🏠 SR Suntour Raidon RL-R 120 mm ▼
- 🔧 GHOST M01 31.8 mm ▼
- 📏 GHOST Low Rizer 720 mm 31.8 mm
- 🔧 Shimano XT 10-Speed ▼
- 🔧 Shimano Deore ▼
- 🔧 Shimano Deore SL ▼
- 🔧 Shimano Deore 40-30-22 ▼
- 🔧 Shimano CS-HG50 11-36 ▼
- 🔧 Shimano 355 Disc 160 mm SMRT 20
- 🔧 Schwalbe Smart Sam 2.25
- 🌙 Rigida Rival 21
- 🔧 Shimano HB-RM 33 QR
- 🔧 Shimano FH-RM 33 QR
- 🔧 GHOST Light DC1 31.6 mm
- 🔧 GHOST VL 1353
- 📏 XS/S/M/L/XL



KATO 5

27,5

KATO 4

27,5



- BLACK / GREEN / BLUE
- ☞ Kato 27.5 Alloy
- ▲ SR Suntour XCR Air RL-R 120 mm ▼
- ▲ GHOST AS GH2 31.8 mm
- GHOST Low Rizer 720 mm 31.8 mm
- ▲ Shimano Deore 9-Speed
- ▲ Shimano Acera ▼
- ▲ Shimano Alivio SL ▼
- ▲ Shimano Alivio 2 Pieces 40-30-22 ▼
- ▲ Shimano CS-HG200 11-34
- Shimano 355 Disc 160 mm SMRT 20
- Schwalbe Smart Sam 2.1
- ☞ Rigida Rival 21 ▼
- ▲ Shimano HB-RM 33 QR
- ▲ Shimano FH-RM 33 QR
- ▲ GHOST Light DC1 31.6 mm
- ▲ GHOST VL 3315
- XS/S/M/L/XL

KATO 3

27,5



- BLACK / GREEN / GREY
- ☞ Kato 27.5 Alloy
- ▲ SR Suntour XCM RL 120 mm ▼
- ▲ GHOST AS GH2 31.8 mm
- GHOST Low Rizer 720 mm 31.8 mm
- ▲ Shimano Deore 9-Speed ▼
- ▲ Shimano FD-M370 ▼
- ▲ Shimano Altus SL ▼
- ▲ Shimano FC 371 44-32-22 ▼
- Shimano CS-HG200 11-34
- Shimano 355 Disc 160 mm SMRT 20 ▼
- Schwalbe Smart Sam 2.1
- ▲ Rigida Rival 19
- ▲ Shimano HB-RM 33 QR
- ▲ Shimano FH-RM 33 QR
- ▲ GHOST Light DC1 31.6 mm
- ▲ GHOST VL 3315
- XS/S/M/L/XL

KATO 4

27,5



- GREEN / DARKGREEN / BLACK
- ☞ Kato 27.5 Alloy
- ▲ SR Suntour XCR Air RL-R 120 mm ▼
- ▲ GHOST AS GH2 31.8 mm
- GHOST Low Rizer 720 mm 31.8 mm
- ▲ Shimano Deore 9-Speed
- ▲ Shimano Acera ▼
- ▲ Shimano Alivio SL ▼
- ▲ Shimano Alivio 2 Pieces 40-30-22 ▼
- ▲ Shimano CS-HG200 11-34
- Shimano 355 Disc 160 mm SMRT 20
- Schwalbe Smart Sam 2.1
- ☞ Rigida Rival 21 ▼
- ▲ Shimano HB-RM 33 QR
- ▲ Shimano FH-RM 33 QR
- ▲ GHOST Light DC1 31.6 mm
- ▲ GHOST VL 3315
- XS/S/M/L/XL

KATO 3

27,5



- GREEN / DARKGREEN / BLACK
- ☞ Kato 27.5 Alloy
- ▲ SR Suntour XCM RL 120 mm ▼
- ▲ GHOST AS GH2 31.8 mm
- GHOST Low Rizer 720 mm 31.8 mm
- ▲ Shimano Deore 9-Speed ▼
- ▲ Shimano FD-M370 ▼
- ▲ Shimano Altus SL ▼
- ▲ Shimano FC 371 44-32-22 ▼
- Shimano CS-HG200 11-34
- Shimano 355 Disc 160 mm SMRT 20 ▼
- Schwalbe Smart Sam 2.1
- ▲ Rigida Rival 19
- ▲ Shimano HB-RM 33 QR
- ▲ Shimano FH-RM 33 QR
- ▲ GHOST Light DC1 31.6 mm
- ▲ GHOST VL 3315
- XS/S/M/L/XL

KATO 2

27,5



- BLACK / GREEN / GREY
- ↳ Kato 27.5 Alloy
- ▲ RST Blaze RL 120 mm ▼
- GHOST AS GH2 31.8 mm
- GHOST Low Rizer 720 mm 31.8 mm
- ▲ Shimano Acera 8-Speed ▼
- ▲ Shimano FD-M190
- ▲ Shimano SL-M310
- ▲ Shimano FC 171 42-34-24
- ◎ Shimano CS-HG200 12-32
- ▲ Tektro ACC 001 Disc 160 mm
- ⊗ Schwalbe Smart Sam 2.1
- ☾ Rigida Rival 19
- ⊕ GHOST Disc Hub Light QR ▼
- ⊕ GHOST Disc Hub Light QR ▼
- ⌘ GHOST Light DC1 31.6 mm
- ▲ GHOST VL 3315
- XS/S/M/L/XL

KATO 1

27,5



- BLACK / RED / GREY
- ↳ Kato 27.5 Alloy
- ▲ RST Blaze ML 120 mm
- GHOST AS GH2 31.8 mm
- GHOST Low Rizer 720 mm 31.8 mm
- ▲ Shimano Altus 8-Speed
- ▲ Shimano FD-M190
- ▲ Shimano SL-M310
- ▲ Shimano FC 171 42-34-24
- ◎ Shimano CS-HG200 12-32
- ▲ Tektro ACC 001 Disc 160 mm
- ⊗ Schwalbe Smart Sam 2.1
- ☾ Rigida Rival 19
- ▲ ⊕ GHOST Disc Hub QR
- ▲ ⊕ GHOST Disc Hub QR
- ⌘ GHOST Light DC1 31.6 mm
- ▲ GHOST VL 3315
- XS/S/M/L/XL

KATO 2

27,5



- BLUE / DARKBLUE / BLACK
- ↳ Kato 27.5 Alloy
- ▲ RST Blaze RL 120 mm ▼
- GHOST AS GH2 31.8 mm
- GHOST Low Rizer 720 mm 31.8 mm
- ▲ Shimano Acera 8-Speed ▼
- ▲ Shimano FD-M190
- ▲ Shimano SL-M310
- ▲ Shimano FC 171 42-34-24
- ◎ Shimano CS-HG200 12-32
- ▲ Tektro ACC 001 Disc 160 mm
- ⊗ Schwalbe Smart Sam 2.1
- ☾ Rigida Rival 19
- ⊕ GHOST Disc Hub Light QR ▼
- ⊕ GHOST Disc Hub Light QR ▼
- ⌘ GHOST Light DC1 31.6 mm
- ▲ GHOST VL 3315
- XS/S/M/L/XL

KATO 1

27,5



- BLUE / DARKBLUE / BLACK
- ↳ Kato 27.5 Alloy
- ▲ RST Blaze ML 120 mm
- GHOST AS GH2 31.8 mm
- GHOST Low Rizer 720 mm 31.8 mm
- ▲ Shimano Altus 8-Speed
- ▲ Shimano FD-M190
- ▲ Shimano SL-M310
- ▲ Shimano FC 171 42-34-24
- ◎ Shimano CS-HG200 12-32
- ▲ Tektro ACC 001 Disc 160 mm
- ⊗ Schwalbe Smart Sam 2.1
- ☾ Rigida Rival 19
- ▲ ⊕ GHOST Disc Hub QR
- ▲ ⊕ GHOST Disc Hub QR
- ⌘ GHOST Light DC1 31.6 mm
- ▲ GHOST VL 3315
- XS/S/M/L/XL

KATO X

ENG

Lighter, stiffer, cooler. Much like the Tacana X, it's the frame that makes the difference. Shorter, more agile geometry, a high-end frame finish, and an optional dropper seat post will give you that Xtra confidence when the terrain gets gnarly. Factor in the light weight and you will find yourself taking time out of your training buddies. Xactly what you want in a mountain bike.

GER

Auch hier macht der Rahmen den Unterschied: Er ist leichter, steifer, begeistert durch perfekte Optik und ist bereits auf den Einsatz von Vario-Stützen vorbereitet. Auf anspruchsvollen Trails gibt dir die kürzere und damit wendigere Geometrie das eXtra an Sicherheit. Dank des niedrigen Gewichtes werden deine Kollegen staunen, wenn sie dir nicht mehr folgen können.



- BLACK / GREY
- 🔧 Kato 27.5 Alloy SL
- 🏠 Rock Shox Reba RL Solo Air 120 mm 15 mm
- 🔧 GHOST GH1 31.8 mm
- 📏 GHOST Low Rizer 720 mm 31.8 mm
- 🔧 Shimano XT 11-Speed Plus
- 🔧 Shimano XT
- 🔧 Shimano XT SL
- 🔧 Shimano XT 36-26
- 🔧 Shimano XT 11-42
- 🔧 Shimano XT Disc 180 mm SMRT 66
- 🔧 Schwalbe Rocket Ron 2.25
- 🔧 Race Face Affect Wheelset
- 🔧 Race Face Affect Wheelset 15 mm
- 🔧 Race Face Affect Wheelset OR
- 🔧 GHOST SL 719 31.6 mm
- 🔧 GHOST VL 1353 SL
- 📏 XS/S/M/L/XL



KATO X 8

27.5

- RED / BLACK
- 🔧 Kato 27.5 Alloy SL
- 🏠 Rock Shox Reba RL Solo Air 120 mm 15 mm
- 🔧 GHOST GH1 31.8 mm
- 📏 GHOST Low Rizer 720 mm 31.8 mm
- ▲ 🔧 Shimano XT 10-Speed Plus
- ▲ 🔧 Shimano Deore
- ▲ 🔧 Shimano Deore SL
- ▲ 🔧 Shimano Deore 36-22
- ▲ 🔧 Shimano CS-HG50 11-36
- ▲ 🔧 Shimano 396 Disc 180 mm
- ▲ 🔧 Schwalbe Rocket Ron 2.25
- ▲ 🔧 Rigida Rival 21
- ▲ 🔧 Shimano Deore 15 mm
- ▲ 🔧 Shimano Deore QR
- 🔧 GHOST SL 719 31.6 mm
- 🔧 GHOST VL 1353 SL
- 📏 XS/S/M/L/XL



KATO X 6

27.5

SONA

ENG

The Sona models give you everything you need to get into mountain biking. They are thought out down to the last little detail and feature mounts for mudguards, kickstands, and even racks. The low top tube ensures plenty of stand-over without compromising integrity, and the 26" wheel size has stood the test of time. Complete with reliable, economical components, these bikes mean riding fun for any size wallet.

GER

Mit einem Sona bekommst du alles, was du für einen guten Start ins Mountainbiken brauchst. Diese Modelle sind durchdacht bis ins letzte Detail und für die Nachrüstung mit Schutzblech, Fahrradständer und sogar Gepäckträger vorbereitet. Die 26-Zoll-Räder sind bewährt und die niedrige Überstandshöhe sorgt für viel Komfort, ohne dabei die Stabilität zu gefährden. In Kombination mit zuverlässigen Komponenten mit erstklassigem Preis-Leistungs-Verhältnis bringt das Sona Fahrspaß für jeden Geldbeutel.



- BLACK/RED/GREY
- 🔧 Sona 26 Alloy
- 📏 RST Gila T 100 mm
- 🔧 GHOST AS GH2 31.8 mm
- 📏 GHOST Rizer 680 mm 31.8 mm
- 🔧 Shimano TX 8000 8-Speed
- 🔧 Shimano FD-M190
- 🔧 Shimano SL-M310
- 🔧 Shimano FC 171 42-34-24
- 🔧 Shimano CS-HG200 12-32
- 🔧 Shimano mech. Disc BR-375 160 mm SMRT 20
- 🔧 Michelin Country Race R 2.10
- 📏 Alex TD 26 Disc
- 🔧 Shimano HB-RM 33 QR
- 🔧 Shimano FH-RM 33 QR
- 🔧 GHOST Light DC1 31.6 mm
- 🔧 GHOST VL 3315
- 📏 XXS/XS/S/M/L/XL



SONA 2

26"

- RED/DARKRED/BLACK
- 🔧 Sona 26 Alloy
- 📏 RST Gila T 100 mm
- 🔧 GHOST AS GH2 31.8 mm
- 📏 GHOST Rizer 680 mm 31.8 mm
- 🔧 Shimano TX 8000 8-Speed
- 🔧 Shimano FD-M190
- 🔧 Shimano SL-M310
- 🔧 Shimano FC 171 42-34-24
- 🔧 Shimano CS-HG200 12-32
- 🔧 Shimano mech. Disc BR-375 160 mm SMRT 20
- 🔧 Michelin Country Race R 2.10
- 📏 Alex TD 26 Disc
- 🔧 Shimano HB-RM 33 QR
- 🔧 Shimano FH-RM 33 QR
- 🔧 GHOST Light DC1 31.6 mm
- 🔧 GHOST VL 3315
- 📏 XXS/XS/S/M/L/XL



SONA 2

26"

NILA

ENG

The 27.5" wheel set combines cross-country smoothness with the agility of a trail bike. Inspired by our professional riders, the extremely lightweight carbon frame comes with all of the features of our HTX LC World Champion bike, and is tuned to the needs of ambitious mountain bikers. This is our XC weapon, offering the highest possible performance, especially for smaller riders.

GER

Mit seinen 27,5-Zoll-Laufrädern kombiniert das Nila die Laufruhe eines Cross-Country-Bikes mit der Wendigkeit eines All Mountains. Inspiriert von den Wünschen unserer Profi-Fahrerinnen haben wir in diesem extrem leichten Carbonrahmen sämtliche Features unseres HTX LC Weltmeister-Bikes integriert und diese an die Anforderungen ambitionierter Enthusiasten angepasst. Es ist ein extrem leistungsfähiges Cross-Country-Bike und insbesondere für kleinere Fahrer die perfekte Wahl.



- BLACK / WHITE / RED
- ▾ Nila 27.5 Carbon
- ▾ Fox 32 Float Performance 100 mm
- ▾ GHOST M01 31.8 mm
- ▾ GHOST Low Rizer 700 mm 31.8 mm
- ▾ Shimano XT 11-Speed Plus
- ▾ Shimano XT
- ▾ Shimano XT SL
- ▾ Shimano XT 36-26
- ▾ Shimano XT 11-40
- ▾ Shimano SLX Disc 180/160 mm
- ▾ Schwalbe Rocket Ron 2.25
- ▾ Rigida Rival 21
- ▾ Shimano Deore DR
- ▾ Shimano Deore DR
- ▾ GHOST Light DC1 31.6 mm
- ▾ GHOST VL 1353
- ▾ XS/S/M/L



LC NILA 5

27.5

- WHITE / BLACK / RED
- ▾ Nila 27.5 Carbon
- ▾ Rock Shox 30 Gold Air RL 100 mm
- ▾ GHOST M01 31.8 mm
- ▾ GHOST Low Rizer 700 mm 31.8 mm
- ▾ Shimano XT 10-Speed
- ▾ Shimano Deore
- ▾ Shimano Deore SL
- ▾ Shimano Deore 40-30-22
- ▾ Shimano CS-HG50 11-36
- ▾ Shimano 396 Disc 180/160 mm
- ▾ Schwalbe Rocket Ron 2.25
- ▾ Rigida Rival 21
- ▾ Shimano 4050 DR
- ▾ Shimano 4050 DR
- ▾ GHOST Light DC1 31.6 mm
- ▾ GHOST VL 1353
- ▾ XS/S/M/L



LC NILA 3

27.5

LANAO FS

ENG

Girl power at its finest. With the invaluable feedback from our all-women GHOST Factory Racing Team, our engineer Tina redesigned all our Miss models and adapted them specifically to women's needs. Not sparing any of the technology advantages in development, the Lanao FS also features top-quality components, and with its 27.5" wheels and 130 mm of travel, it is up for every single one of your adventures. For girls by girls, this is our new Miss series.

GER

Frauen-Power! Mit dem Feedback des GHOST-Frauenteam hat unsere Entwicklerin Tina all unsere Miss-Modelle überarbeitet und sie speziell an die Bedürfnisse von Bikerinnen angepasst. Wir haben bei diesem Bike an nichts gespart und hochwertigste Komponenten verbaut. Es ist leichter, steifer und begeistert mit seiner optimierten Kinematik am Hinterbau. So nimmt es dieses Fahrrad mit seinen 27,5-Zoll-Rädern und 130 Millimeter Federweg mit jedem Abenteuer auf. For girls by girls – das ist unsere neue Miss-Serie.



Lanao FS shares AMR platform features

- MINT / BLACK
- ▾ Lanao FS Alloy
- ▾ Fox 32 Float Performance 130 mm
- ▲ X-Fusion 02 RL 130 mm
- ▾ GHOST AS GH2 31.8 mm
- ▾ GHOST Low Rizer Light 700 mm 31.8 mm
- ▲ Shimano XT 10-Speed Plus
- ▲ Shimano Deore
- ▲ Shimano Deore
- ▲ Shimano Deore 40-30-22
- ▲ Shimano CS-HG 50 11-36
- ▲ Shimano 396 Disc 180 mm
- ▲ Michelin Wild Grip'R 2.25
- ▾ Rigida Rival 21
- ▾ Shimano Deore QR
- ▾ Shimano Deore QR
- ▾ GHOST Light DC 1 31.6 mm
- ▾ GHOST VL 4212
- ▾ S/M/L



LANAO FS 4

27,5"

LANAO FS 7

27,5"

- GREY / PINK
- ▾ Lanao FS Alloy
- ▾ Fox 32 Float Performance 130 mm
- ▾ Fox Float Performance 3 Pos 130 mm
- ▾ GHOST AS GH2 31.8 mm
- ▾ GHOST Low Rizer Light 700 mm 31.8 mm
- ▾ Shimano XT 11-Speed Plus
- ▾ Shimano XT
- ▾ Shimano XT
- ▾ Shimano XT 36-26
- ▾ Shimano XT 11-42
- ▾ Shimano Deore Disc 180 mm
- ▾ Michelin Wild Grip'R 2.25
- ▾ Rigida Rival 21
- ▾ Shimano Deore QR
- ▾ Shimano Deore QR
- ▾ GHOST Light DC 1 31.6 mm
- ▾ GHOST VL 4212
- ▾ S/M/L

- BLUE / BLACK
- ▾ Lanao FS Alloy
- ▲ RST Aerial Air LO 130 mm
- ▾ X-Fusion 02 RL 130 mm
- ▾ GHOST AS GH2 31.8 mm
- ▾ GHOST Low Rizer Light 700 mm 31.8 mm
- ▲ Shimano Deore 10-Speed Plus
- ▾ Shimano Deore
- ▾ Shimano Deore
- ▲ Shimano 523 40-30-22
- ▾ Shimano CS-HG 50 11-36
- ▲ Tektro ACC 001 180 mm
- ▾ Schwabe Smart Sam 2.25
- ▾ Rigida Rival 19
- ▾ GHOST Disc QR
- ▾ GHOST Disc QR
- ▾ GHOST Light DC 1 31.6 mm
- ▾ GHOST VL 4212
- ▾ S/M/L



LANAO FS 2

27,5"

LANAO

ENG

The special women's specific top tube results in a low stand-over height ensuring your safety in any situation. Selected 27.5" wheels remain stable even at top speeds, but still deliver nimble handling to make it around the tightest of switchbacks. It's not an optical illusion, this Miss bike simply makes you fast!

GER

Das für Frauen optimierte Oberrohr sorgt für einen tiefen Überstand und damit für Sicherheit in jeder Situation. Die 27,5-Zoll-Laufräder verleihen dem Bike selbst bei hohen Geschwindigkeiten Stabilität und Laufruhe. Aber dank des einfachen Handlings kann man mit ihm immer noch um die engsten Spitzkehren herumzirkeln. Es kommt dir nicht nur so vor, dieses Bike macht wirklich schnell!

LANAO 5

27,5

- WHITE / RED / DARKRED / BLUE
- ▾ Lanao 27.5 Alloy
- ▲ SR Suntour Raidon RL-R 100 mm
- ▾ GHOST M01 31.8 mm
- ▾ GHOST Rizer 680 mm 31.8 mm
- ▾ Shimano XT 10-Speed
- ▾ Shimano Deore
- ▾ Shimano Deore SL
- ▾ Shimano Deore 40-30-22
- ▾ Shimano CS-HG50 11-36
- ▲ Shimano 355 Disc 160 mm SMRT 20
- ▾ Schwalbe Smart Sam 2.1
- ▲ Rigid Rival 19
- ▲ Shimano HB-RM 33 QR
- ▲ Shimano FH-RM 33 QR
- ▾ GHOST Light DC1 31.6 mm
- ▾ GHOST VL 4212 Lady
- ▾ XS/S/M/L/XL



LANAO 7

27,5

- BLACK / WHITE / PINK / BLUE
- ▾ Lanao 27.5 Alloy
- ▾ Rock Shox 30 Gold Air RL 100 mm
- ▾ GHOST M01 31.8 mm
- ▾ GHOST Rizer 680 mm 31.8 mm
- ▾ Shimano XT 10-Speed
- ▾ Shimano Deore
- ▾ Shimano Deore SL
- ▾ Shimano Deore 40-30-22
- ▾ Shimano CS-HG50 11-36
- ▾ Shimano 396 Disc 180/160 mm
- ▾ Schwalbe Smart Sam 2.25
- ▾ Rigid Rival 21
- ▾ Shimano Deore QR
- ▾ Shimano Deore QR
- ▾ GHOST Light DC1 31.6 mm
- ▾ GHOST VL 4212 Lady
- ▾ XS/S/M/L/XL



- PURPLE / BLACK / PINK
- ▾ Lanao 27.5 Alloy
- ▲ SR Suntour Raidon RL-R 100 mm
- ▾ GHOST M01 31.8 mm
- ▾ GHOST Rizer 680 mm 31.8 mm
- ▾ Shimano XT 10-Speed
- ▾ Shimano Deore
- ▾ Shimano Deore SL
- ▾ Shimano Deore 40-30-22
- ▾ Shimano CS-HG50 11-36
- ▲ Shimano 355 Disc 160 mm SMRT 20
- ▾ Schwalbe Smart Sam 2.1
- ▲ Rigid Rival 19
- ▲ Shimano HB-RM 33 QR
- ▲ Shimano FH-RM 33 QR
- ▾ GHOST Light DC1 31.6 mm
- ▾ GHOST VL 4212 Lady
- ▾ XS/S/M/L/XL



LANAO 5

27,5

LANAO 4

27,5



- WHITE/RED/DARKRED/BLUE
- ↳ Lanao 27.5 Alloy
- ▲ SR Suntour XCR Air RL-R 100 ▼
- GHOST AS GH2 31.8 mm
- GHOST Rizer 680 mm 31.8 mm
- ▲ Shimano Deore 9-Speed ▼
- ▲ Shimano Acera ▼
- ▲ Shimano Alivio SL ▼
- ▲ Shimano Alivio 2 Pieces 40-30-22 ▼
- ▲ Shimano CS-HG200 11-34
- Shimano 355 Disc 160 mm SMRT 20
- Schwalbe Smart Sam 2.1
- ☾ Rigida Rival 19
- ⚙ Shimano HB-RM 33 QR
- ⚙ Shimano FH-RM 33 QR
- 🔧 GHOST Light DC1 31.6 mm
- 👤 GHOST VL 4212 Lady
- XS/S/M/L/XL

LANAO 3

27,5



- WHITE/BLUE/LIGHTBLUE
- ↳ Lanao 27.5 Alloy
- ▲ SR Suntour XCM 30 RL 100 mm ▼
- GHOST AS GH2 31.8 mm
- GHOST Rizer 680 mm 31.8 mm
- ▲ Shimano Deore 9-Speed ▼
- ▲ Shimano FD-M370 ▼
- ▲ Shimano Altus SL ▼
- ▲ Shimano FC 371 44-32-22 ▼
- Shimano CS-HG200 11-34
- Shimano 355 Disc 160 mm SMRT 20 ▼
- Schwalbe Smart Sam 2.1
- ☾ Rigida Rival 19
- ⚙ Shimano HB-RM 33 QR
- ⚙ Shimano FH-RM 33 QR
- 🔧 GHOST Light DC1 31.6 mm
- 👤 GHOST VL 4212 Lady
- XS/S/M/L/XL

LANAO 4

27,5



- MINT/DARKMINT/WHITE/PINK
- ↳ Lanao 27.5 Alloy
- ▲ SR Suntour XCR Air RL-R 100 ▼
- GHOST AS GH2 31.8 mm
- GHOST Rizer 680 mm 31.8 mm
- ▲ Shimano Deore 9-Speed ▼
- ▲ Shimano Acera ▼
- ▲ Shimano Alivio SL ▼
- ▲ Shimano Alivio 2 Pieces 40-30-22 ▼
- ▲ Shimano CS-HG200 11-34
- Shimano 355 Disc 160 mm SMRT 20
- Schwalbe Smart Sam 2.1
- ☾ Rigida Rival 19
- ⚙ Shimano HB-RM 33 QR
- ⚙ Shimano FH-RM 33 QR
- 🔧 GHOST Light DC1 31.6 mm
- 👤 GHOST VL 4212 Lady
- XS/S/M/L/XL

LANAO 3

27,5



- MINT/DARKMINT/WHITE/PINK
- ↳ Lanao 27.5 Alloy
- ▲ SR Suntour XCM 30 RL 100 mm ▼
- GHOST AS GH2 31.8 mm
- GHOST Rizer 680 mm 31.8 mm
- ▲ Shimano Deore 9-Speed ▼
- ▲ Shimano FD-M370 ▼
- ▲ Shimano Altus SL ▼
- ▲ Shimano FC 371 44-32-22 ▼
- Shimano CS-HG200 11-34
- Shimano 355 Disc 160 mm SMRT 20 ▼
- Schwalbe Smart Sam 2.1
- ☾ Rigida Rival 19
- ⚙ Shimano HB-RM 33 QR
- ⚙ Shimano FH-RM 33 QR
- 🔧 GHOST Light DC1 31.6 mm
- 👤 GHOST VL 4212 Lady
- XS/S/M/L/XL

LANAO 2

27,5



- WHITE / BLUE / LIGHTBLUE
- ↳ Lanao 27.5 Alloy
- ▲ RST Blaze RL 100 mm ▼
- GHOST AS GH2 31.8 mm
- GHOST Rizer 680 mm 31.8 mm
- ▲ Shimano Acera 8-Speed ▼
- ▲ Shimano FD-M190
- ▲ Shimano SL-M310
- ▲ Shimano FC 171 42-34-24
- ◎ Shimano CS-HG200 12-32
- ▲ Tektro ACC 001 Disc 160 mm
- ⊗ Schwalbe Smart Sam 2.1
- ☾ Rígida Rival 19
- ✚ GHOST Disc Hub Light QR ▼
- ✚ GHOST Disc Hub Light QR ▼
- ⚖ GHOST Light DC1 31.6 mm
- ▲ GHOST VL 4212 Lady
- XS/S/M/L/XL

LANAO 1

27,5



- WHITE / PINK / PURPLE
- ↳ Lanao 27.5 Alloy
- ▲ RST Gila ML 100 mm
- GHOST AS GH2 31.8 mm
- GHOST Rizer 680 mm 31.8 mm
- ▲ Shimano Altus 8-Speed
- ▲ Shimano FD-M190
- ▲ Shimano SL-M310
- ▲ Shimano FC 171 42-34-24
- ◎ Shimano CS-HG200 12-32
- ▲ Tektro ACC 001 Disc 160 mm
- ⊗ Schwalbe Smart Sam 2.1
- ☾ Rígida Rival 19
- ▲ ✚ GHOST Disc Hub QR
- ▲ ✚ GHOST Disc Hub QR
- ⚖ GHOST Light DC1 31.6 mm
- ▲ GHOST VL 4212 Lady
- XS/S/M/L/XL

LANAO 2

27,5



- DARKBLUE / WHITE / CYAN / PINK
- ↳ Lanao 27.5 Alloy
- ▲ RST Blaze RL 100 mm ▼
- GHOST AS GH2 31.8 mm
- GHOST Rizer 680 mm 31.8 mm
- ▲ Shimano Acera 8-Speed ▼
- ▲ Shimano FD-M190
- ▲ Shimano SL-M310
- ▲ Shimano FC 171 42-34-24
- ◎ Shimano CS-HG200 12-32
- ▲ Tektro ACC 001 Disc 160 mm
- ⊗ Schwalbe Smart Sam 2.1
- ☾ Rígida Rival 19
- ✚ GHOST Disc Hub Light QR ▼
- ✚ GHOST Disc Hub Light QR ▼
- ⚖ GHOST Light DC1 31.6 mm
- ▲ GHOST VL 4212 Lady
- XS/S/M/L/XL

LANAO 1

27,5



- DARKBLUE / WHITE / CYAN / PINK
- ↳ Lanao 27.5 Alloy
- ▲ RST Gila ML 100 mm
- GHOST AS GH2 31.8 mm
- GHOST Rizer 680 mm 31.8 mm
- ▲ Shimano Altus 8-Speed
- ▲ Shimano FD-M190
- ▲ Shimano SL-M310
- ▲ Shimano FC 171 42-34-24
- ◎ Shimano CS-HG200 12-32
- ▲ Tektro ACC 001 Disc 160 mm
- ⊗ Schwalbe Smart Sam 2.1
- ☾ Rígida Rival 19
- ▲ ✚ GHOST Disc Hub QR
- ▲ ✚ GHOST Disc Hub QR
- ⚖ GHOST Light DC1 31.6 mm
- ▲ GHOST VL 4212 Lady
- XS/S/M/L/XL

LAWU

ENG

With a sleek design, women's specific top tube and components especially tuned to your needs, this economical line of our Miss Bikes offers you everything you need to have fun riding. Drop what you're doing for a while and enjoy some time on your new bike.

GER

Auch die günstige Linie unserer Miss-Bikes bietet alles, was du zum Biken brauchst: ein ansprechendes Design, ein Frauen spezifisches Oberrohr und speziell auf deine Bedürfnisse angepasste Komponenten. Lass den Alltag hinter dir und genieße die Zeit auf deinem Bike.



- BLACK / PINK / BLUE
- ↳ Lawu 26 Alloy
- ┆ RST Gila T 100 mm
- ▣ GHOST AS GH2 31.8 mm
- ┄ GHOST Rizer 660 mm 31.8 mm
- ⚙ Shimano TX 800 8-Speed
- ┆ Shimano FD-M190
- ⊕ Shimano SL-M310
- ⚙ Shimano FC 171 42-34-24
- ⊙ Shimano CS-HG200 12-32
- ⊙ Shimano mech. Disc BR-375 160 mm SMRT 20
- ⊙ Michelin Country Race R 2.10
- ☾ Alex TD 26 Disc
- ⚙ Shimano HB-RM 33 QR
- ⚙ Shimano FH-RM 33 QR
- ┆ GHOST Light DC1 31.6 mm
- ┆ GHOST VL 4212 Lady
- ┆ XS/S/M/L/XL

LAWU 2

26"



- WHITE / PINK / PURPLE
- ↳ Lawu 26 Alloy
- ┆ RST Gila T 100 mm
- ▣ GHOST AS GH2 31.8 mm
- ┄ GHOST Rizer 660 mm 31.8 mm
- ⚙ Shimano TX 8000 8-Speed
- ┆ Shimano FD-M190
- ⊕ Shimano SL-M310
- ⚙ Shimano FC 171 42-34-24
- ⊙ Shimano CS-HG200 12-32
- ⊙ Shimano mech. Disc BR-375 160 mm SMRT 20
- ⊙ Michelin Country Race R 2.10
- ☾ Alex TD 26 Disc
- ⚙ Shimano HB-RM 33 QR
- ⚙ Shimano FH-RM 33 QR
- ┆ GHOST Light DC1 31.6 mm
- ┆ GHOST VL 4212 Lady
- ┆ XS/S/M/L/XL

LAWU 2

26"



TERU FS

ENG

Meet our all-mountain, full suspension E-bike. Riding the Teru FS E-bike with 130 mm of travel in the front and 120 mm in the rear means unlimited off-road riding fun. The 29" wheels ensure excellent traction and stability, and because you are perfectly assisted by the new Bosch motor with Performance CX drive and longer battery life, you can ride even harder and longer.

GER

Dürfen wir vorstellen: unser neues vollgefedertes All Mountain E-Bike. Dieses E-Bike mit seinen 130 mm Federweg vorne und 120 mm hinten macht viel Spaß, insbesondere abseits befestigter Wege. Die 29-Zoll-Räder geben dem Bike eine erstklassige Traktion und Stabilität und der neue Bosch-Motor mit Performance CX-Antrieb sorgt mit größerer Akku-Kapazität und höherem Drehmoment für kräftige Unterstützung. So kannst du noch längere und noch anspruchsvollere Touren fahren.



Bosch Performance Drive

- BLACK / RED / WHITE
- ▾ Teru FS Alloy
- ▲ Fox 34 Float Performance 130mm 15mm
- ▲ Fox Float DPS Performance 120mm
- ▲ GHOST AS-M01 31.8 mm
- ▾ GHOST Low Rizer Light 720 mm 31.8 mm
- ▾ Shimano XT 11-Speed
- ▾ Shimano XT SL
- ▾ Miranda Delta 15
- ▾ Shimano XT 11-Speed 11-40
- ▲ Shimano Deore Disc 180mm SM-RT 64
- ▾ Schwalbe Nobby Nic 2.25
- ▾ Mach 1 650 Disc
- ▲ Shimano Deore 15 mm
- ▲ Shimano Deore 12 mm
- ▲ GHOST Light SP DC 1 31.6 mm
- ▾ Selle Royal Seta
- ▾ S/M/L
- ▾ Bosch Intuvia
- ▾ Bosch Performance CX (250 W)
- ▾ Bosch Power Pack 500 Wh

TERU FS 7

29"



TERU FS 9

29"

- BLACK / BLUE / ORANGE
- ▾ Teru FS Alloy
- ▲ Fox 34 Float Performance Elite 130 mm 15 mm
- ▲ Fox Float DPS Performance Elite 120 mm
- ▾ GHOST Light AS-029 31.8 mm
- ▾ GHOST Low Rizer Light 720 mm 31.8 mm
- ▾ Shimano XT 11-Speed
- ▾ Shimano XT SL
- ▾ Miranda Delta 15
- ▾ Shimano XT 11-Speed 11-40
- ▾ Shimano XT Disc 180 mm SM-RT 81
- ▾ Schwalbe Nobby Nic 2.25
- ▾ Mach 1 650 Disc
- ▾ Shimano XT 15 mm
- ▾ Shimano XT 12 mm
- ▾ Kind Shock LEV Integra 31.6 mm
- ▾ Selle Royal Seta
- ▾ S/M/L
- ▾ Bosch Intuvia
- ▾ Bosch Performance CX (250 W)
- ▾ Bosch Power Pack 500 Wh



- BLACK / BLUE / WHITE
- ▾ Teru FS Alloy
- ▲ Rock Shox Sektor Solar Air 130 mm 15 mm
- ▲ Rock Shox Monarch RL 120 mm
- ▾ GHOST AS-GH2 31.8 mm
- ▾ GHOST Low Rizer Light 720 mm 31.8 mm
- ▲ Shimano Deore 10-Speed Plus
- ▲ Shimano Deore SL
- ▾ Miranda Delta 15
- ▲ Shimano CS-HG 50 11-36
- ▲ Shimano 396 Disc 180 mm SM-RT 20
- ▾ Schwalbe Nobby Nic 2.25
- ▾ Mach 1 650 Disc
- ▾ Shimano Deore 15 mm
- ▾ Shimano Deore 12 mm
- ▾ GHOST Light SP DC 1 31.6 mm
- ▾ Selle Royal Seta
- ▾ S/M/L
- ▾ Bosch Intuvia
- ▾ Bosch Performance CX (250 W)
- ▾ Bosch Power Pack 500 Wh

TERU FS 5

29"



TERU FS X

ENG

This is our long-travel, full suspension E-bike. Riding the Teru FS X with 150 mm of travel in the front and 140 mm in the rear means eXtra off-road riding fun. The 27.5" wheels provide great traction and quick handling in tight quarters, and because you are perfectly assisted by the new Bosch Performance CX motor with longer battery life, you can easily add another trail to your ride.

GER

Unser E-Bike für alle Freunde von viel Federweg. 150 mm Dämpfung vorne und 140 mm hinten sorgen dafür, dass der Spaß beginnt, wo der Asphalt endet. Die 27,5-Zoll-Räder sorgen auch bei hohem Tempo und engen Kurven für perfekten Grip. Und dank dem neuen Bosch Performance CX-Motor mit extra langer Akku-Laufzeit ist keine Tour zu weit.



- BLACK / RED / GREY
- Teru FS X Alloy
- h Fox 34 Float Performance Elite 150 mm 15 mm ▼
- h Fox Float DPS Performance Elite 140 mm ●
- GHOST AS-M04 35 mm
- GHOST Rizer Light 760 mm 35 mm
- h Shimano XTR Plus 11-Speed ▼
- h Shimano XTR SL ▼
- h Miranda Delta 15
- h Shimano XT 11-Speed 11-40 ●
- h Shimano XT Disc 203/180 mm SM-RT 64 ▼
- h Schwalbe Nobby Nic 2.35
- Mach 1 650 Disc
- h Shimano XT 15 mm ▼
- h Shimano XT 12 mm ▼
- h Rock Shox Reverb Stealth 31.6 mm adjustable SP, internal routing ▼
- Selle Royal Seta
- S/M/L
- Bosch Nyon
- Bosch Performance CX (250 W)
- Bosch Power Pack 500 Wh

TERU FS X 10

27.5"



- BLACK / GREEN / WHITE
- Teru FS X Alloy
- h Rock Shox Revelation RL Solo Air 150 mm 15 mm ▲
- h Rock Shox Monarch RL Debonair 140 mm ●
- GHOST AS-M04 35 mm
- GHOST Rizer Light 760 mm 35 mm
- h Sram GX 11-Speed ▲
- h Sram GX SL ▲
- h Miranda Delta 15
- h Sram XG 1150 10-42 ●
- h Sram Guide R 200/180 mm ▲
- h Schwalbe Nobby Nic 2.35
- Mach 1 650 Disc
- h GHOST Hub 15 mm ▲
- h GHOST Hub 12 mm ▲
- h Kind Shock LEV Integra 31.6 mm ▲
- Selle Royal Seta
- S/M/L
- Bosch Intuvia ▲
- Bosch Performance CX (250 W)
- Bosch Power Pack 500 Wh

TERU FS X 6

27.5"



TERU

ENG

Our Teru models come in both ladies' and men's versions, the Teru LC bikes with Bosch Performance CX drive motors, 27.5" wheels, and all the characteristics of a true mountain bike. Sporting a sensationally low weight of only 16.9 kg, our ultra-featherweight Teru LC sets a new benchmark among E-Bikes. Its one-of-a-kind design, combined with an extremely stiff carbon frame, distinguishes the Teru as a true, no-compromise mountain bike with plenty of extra propulsion.

GER

Unsere Teru-Modelle gibt es sowohl für Frauen als auch für Männer. Die Teru LC Modelle sind mit dem Bosch Performance CX-Antrieb, 27,5-Zoll-Rädern und allen Vorteilen herkömmlicher Mountainbikes ausgestattet. Dank des sensationell niedrigen Gewichts von nur 16,9 Kilo setzt das ultraleichte Teru LC eine Rekordmarke im Segment der E-Bikes. Mit seinem einzigartigen Design und dem extrem steifen Carbon-Rahmen ist das Teru ein kompromissloses Mountainbike mit unbändigem Vortrieb.



- BLACK / RED / GREY
- ▾ Teru Carbon
- ▾ Fox 32 Float Factory Kashima Remote 100 mm 15 mm
- ▾ Race Face Turbine 31.8 mm
- ▾ Race Face Next Carbon 720 mm 31.8 mm
- ▾ Shimano XTR 11-Speed
- ▾ Shimano XTR SL
- ▾ Miranda Delta 15
- ▾ Shimano XTR 11-Speed 11-40
- ▾ Shimano XTR Disc 180 mm SM-RT 86
- ▾ Schwalbe Rocket Ron 2.25
- ▾ DT Swiss XM 1501 Spline One Wheelset
- ▾ DT Swiss XM 1501 Spline One Wheelset 15 mm
- ▾ DT Swiss XM 1501 Spline One Wheelset QR
- ▾ Race Face Next 27.2 mm
- ▾ Selle Italia SLR Kit Carbonio
- ▾ S / M / L
- ▾ Bosch Nyon
- ▾ Bosch Performance CX (250 W)
- ▾ Bosch Power Pack 500 Wh



LC TERU 10

27.5

- BLACK / BLUE / ORANGE
- ▾ Teru Carbon
- ▾ Fox 32 Float Performance Remote 100 mm 15 mm
- ▾ GHOST Light AS-029 31.8 mm
- ▾ GHOST Low Rizer Light 720 mm 31.8 mm
- ▾ Shimano XT 11-Speed
- ▾ Shimano XT SL
- ▾ Miranda Delta 15
- ▾ Shimano XT 11-Speed 11-40
- ▾ Shimano XT Disc 180 mm SM-RT 76
- ▾ Schwalbe Rocket Ron 2.25
- ▾ Race Face Affect Wheelset
- ▾ Race Face Affect Wheelset 15 mm
- ▾ Race Face Affect Wheelset QR
- ▾ GHOST SL SP 719 27.2 mm
- ▾ GHOST VL 1353
- ▾ S / M / L
- ▾ Bosch Intuvia
- ▾ Bosch Performance CX (250 W)
- ▾ Bosch Power Pack 500 Wh



LC TERU 9

27.5

TERU 8

27,5



- BLACK / RED / WHITE
- ▲ Teru Alloy
- ▲ Rock Shox Reba RL Solo Air 120 mm Oneloc 15 mm
- ▲ GHOST Light AS-029 31.8 mm
- GHOST Low Rizer Light 720 mm 31.8 mm
- Shimano XT 11-Speed
- Shimano XT SL
- Miranda Delta 15
- Shimano XT 11-Speed 11-40
- Shimano XT Disc 180 mm SM-RT 64
- Schwalbe Rocket Ron 2.25
- ▲ Rigida Rival 21
- ▲ Shimano XT 15 mm
- ▲ Shimano XT QR
- ▲ GHOST SL SP 719 31.6 mm
- ▲ GHOST VL 1353
- S / M / L
- Bosch Intuvia
- Bosch Performance Cruise (250 W)
- Bosch Power Pack 500 Wh

TERU 6

27,5



- BLACK / GREEN / WHITE
- ▲ Teru Alloy
- ▲ Rock Shox Recon Gold Solo Air 120 mm Oneloc 15 mm
- ▲ GHOST AS-M01 31.8 mm
- GHOST Low Rizer Light 720 mm 31.8 mm
- Shimano XT 11-Speed
- Shimano XT SL
- Miranda Delta 15
- Shimano XT 11-Speed 11-40
- ▲ Shimano 506 Disc 180 mm SM-RT 20
- ▲ Schwalbe Smart Sam 2.25
- Rigida Rival 21
- ▲ Shimano Deore 15 mm
- ▲ Shimano Deore QR
- ▲ GHOST Light SP DC 1 31.6 mm
- ▲ GHOST VL 1353
- S / M / L
- Bosch Intuvia
- Bosch Performance Cruise (250 W)
- Bosch Power Pack 500 Wh

TERU 8 MISS

27,5



- BLACK / RED / WHITE
- ▲ Teru Miss Alloy
- ▲ Rock Shox Reba RL Solo Air 120 mm Oneloc 15 mm
- ▲ GHOST Light AS-029 31.8 mm
- GHOST Low Rizer Light 720 mm 31.8 mm
- Shimano XT 11-Speed
- Shimano XT SL
- Miranda Delta 15
- Shimano XT 11-Speed 11-40
- Shimano XT Disc 180 mm SM-RT 64
- Schwalbe Rocket Ron 2.25
- ▲ Rigida Rival 21
- ▲ Shimano XT 15 mm
- ▲ Shimano XT QR
- ▲ GHOST SL SP 719 31.6 mm
- ▲ GHOST VL 4212
- S / M / L
- Bosch Intuvia
- Bosch Performance Cruise (250 W)
- Bosch Power Pack 500 Wh

TERU 6 MISS

27,5



- BLACK / GREEN / WHITE
- ▲ Teru Miss Alloy
- ▲ Rock Shox Recon Gold Solo Air 120 mm Oneloc 15 mm
- ▲ GHOST AS-M01 31.8 mm
- GHOST Low Rizer Light 720 mm 31.8 mm
- Shimano XT 11-Speed
- Shimano XT SL
- Miranda Delta 15
- Shimano XT 11-Speed 11-40
- ▲ Shimano 506 Disc 180 mm SM-RT 20
- ▲ Schwalbe Smart Sam 2.25
- Rigida Rival 21
- ▲ Shimano Deore 15 mm
- ▲ Shimano Deore QR
- ▲ GHOST Light SP DC 1 31.6 mm
- ▲ GHOST VL 4212
- S / M / L
- Bosch Intuvia
- Bosch Performance Cruise (250 W)
- Bosch Power Pack 500 Wh

TERU 5

27,5



- BLACK / GREY / WHITE
- Teru Alloy
- ▲ Rock Shox Recon Silver Solo Air 120 mm LO 15 mm ▼
- ▲ GHOST AS-GH2 31.8 mm
- GHOST Low Rizer Light 720 mm 31.8 mm
- ▲ Shimano XT 10-Speed ▼
- ▲ Shimano Deore SL
- Miranda Delta 15
- ▲ Shimano CS-HG50 11-36 ▼
- ▲ Shimano 355 Disc 180 mm
- Schwalbe Smart Sam 2.25
- Rigida Rival 21
- Shimano Deore 15 mm
- Shimano Deore QR
- GHOST Light SP DC 1 31.6 mm
- GHOST VL 1353
- S / M / L
- Bosch Intuvia
- Bosch Performance Cruise (250 W)
- Bosch Power Pack 500 Wh

TERU 4

27,5



- BLACK / BLUE / WHITE
- Teru Alloy
- ▲ SR Suntour SF 15 XCR 120 mm 15 mm
- ▲ GHOST AS-GH2 31.8 mm
- GHOST Low Rizer Light 720 mm 31.8 mm
- ▲ Shimano Deore 9-Speed
- Shimano Deore SL
- Miranda Delta 15
- ▲ Shimano CS-HG300 11-34
- Shimano 355 Disc 180 mm SM-RT 20
- Schwalbe Smart Sam 2.25
- Rigida Rival 21
- Shimano Deore 15 mm
- Shimano Deore QR
- GHOST Light SP DC 1 31.6 mm
- GHOST VL 1353
- S / M / L
- Bosch Intuvia
- Bosch Performance Cruise (250 W)
- Bosch Power Pack 400 Wh

TERU 5 MISS

27,5



- BLACK / GREY / WHITE
- Teru Miss Alloy
- ▲ Rock Shox Recon Silver Solo Air 120 mm LO 15 mm ▼
- ▲ GHOST AS-GH2 31.8 mm
- GHOST Low Rizer Light 720 mm 31.8 mm
- ▲ Shimano XT 10-Speed ▼
- ▲ Shimano Deore SL
- Miranda Delta 15
- ▲ Shimano CS-HG50 11-36 ▼
- ▲ Shimano 355 Disc 180 mm
- Schwalbe Smart Sam 2.25
- Rigida Rival 21
- Shimano Deore 15 mm
- Shimano Deore QR
- GHOST Light SP DC 1 31.6 mm
- GHOST VL 4212
- S / M / L
- Bosch Intuvia
- Bosch Performance Cruise (250 W)
- Bosch Power Pack 500 Wh

TERU 4 MISS

27,5



- BLACK / BLUE / WHITE
- Teru Miss Alloy
- ▲ SR Suntour SF 15 XCR 120 mm 15 mm
- ▲ GHOST AS-GH2 31.8 mm
- GHOST Low Rizer Light 720 mm 31.8 mm
- ▲ Shimano Deore 9-Speed
- Shimano Deore SL
- Miranda Delta 15
- ▲ Shimano CS-HG300 11-34
- Shimano 355 Disc 180 mm SM-RT 20
- Schwalbe Smart Sam 2.25
- Rigida Rival 21
- Shimano Deore 15 mm
- Shimano Deore QR
- GHOST Light SP DC 1 31.6 mm
- GHOST VL 4212
- S / M / L
- Bosch Intuvia
- Bosch Performance Cruise (250 W)
- Bosch Power Pack 400 Wh

ANDASOL CROSS

ENG

An elegant hydro-formed aluminum frame and the latest generation of Bosch motors pair to comprise the most important elements of the purist Andasol Cross series. To enhance your riding fun, this athletic model was reduced to under 20 kg, making it the ideal companion on your way to class at college, to work or simply to extend the range of your pedaling adventures.

GER

In diesem E-Bike wurde ein eleganter, hydrogeformter Aluminiumrahmen mit der neusten Generation der Bosch-Motoren vereint. Damit dieses Modell noch mehr Spaß macht, haben wir es so lange auf Diät gesetzt, bis die Waage weniger als 20 Kilo angezeigt hat. Es ist der perfekte Begleiter – auf dem Weg zur Uni und Arbeit genauso wie auf langen Abenteuern im Sattel.



ANDASOL CROSS 9

28"

- BLACK / RED / GREY
- ▾ Andasol Cross Alloy
- ▾ RST Vogue Air TNL LO 60 mm
- ▾ GHOST Light AS-029 31.8 mm
- ▾ GHOST Low Rizer Light 660 mm 31.8 mm
- ▾ Shimano XT 11-Speed
- ▾ Shimano XT SL
- ▾ Miranda Delta 18
- ▾ Shimano XT 11-Speed 11-40
- ▾ Shimano XT Disc 180 mm SM-RT 64
- ▾ Schwalbe Smart Sam Sport 1.6
- ▾ Ryde Rival 19
- ▾ Shimano XT QR
- ▾ Shimano XT QR
- ▾ GHOST Light SP DC 1 27.2 mm
- ▾ GHOST VL 3315
- ▾ S / M / L
- ▾ Bosch Intuvia
- ▾ Bosch Performance Cruise (250 W)
- ▾ Bosch Power Pack 500 Wh



ANDASOL CROSS 9 MISS

28"

- BLACK / RED / GREY
- ▾ Andasol Cross Miss Alloy
- ▾ RST Vogue Air TNL LO 60 mm
- ▾ GHOST Light AS-029 31.8 mm
- ▾ GHOST Low Rizer Light 660 mm 31.8 mm
- ▾ Shimano XT 11-Speed
- ▾ Shimano XT SL
- ▾ Miranda Delta 18
- ▾ Shimano XT 11-Speed 11-40
- ▾ Shimano XT Disc 180 mm SM-RT 64
- ▾ Schwalbe Smart Sam Sport 1.6
- ▾ Ryde Rival 19
- ▾ Shimano XT QR
- ▾ Shimano XT QR
- ▾ GHOST Light SP DC 1 27.2 mm
- ▾ GHOST VL 4212
- ▾ S / M / L
- ▾ Bosch Intuvia
- ▾ Bosch Performance Cruise (250 W)
- ▾ Bosch Power Pack 500 Wh



ANDASOL CROSS 7

28"



- BLACK / GREEN / BLUE
- Andasol Cross Alloy
- ▲ RST Nova TnL 60 mm
- ▲ GHOST AS-GH2 31.8 mm
- GHOST Low Rizer Light 660 mm 31.8 mm
- ▲ Shimano Deore 9-Speed
- ▲ Shimano Alivio SL
- ▲ Miranda Delta 18
- ▲ Shimano Alivio 11-34
- ▲ Tektro ACC 001 Disc 180 mm
- Schwalbe Smart Sam Sport 1.6
- Ryde Rival 19
- ▲ GHOST Disc Hub QR
- ▲ GHOST Disc Hub QR
- ▲ GHOST Light SP DC 1 27.2 mm
- ▲ GHOST VL 3315
- S / M / L
- Bosch Intuvia
- Bosch Performance Cruise (250 W)
- Bosch Power Pack 400 Wh

ANDASOL CROSS 7 MISS

28"



- BLACK / GREEN / BLUE
- Andasol Cross Miss Alloy
- ▲ RST Nova TnL 60 mm
- ▲ GHOST AS-GH2 31.8 mm
- GHOST Low Rizer Light 660 mm 31.8 mm
- ▲ Shimano Deore 9-Speed
- ▲ Shimano Alivio SL
- ▲ Miranda Delta 18
- ▲ Shimano Alivio 11-34
- ▲ Tektro ACC 001 Disc 180 mm
- Schwalbe Smart Sam Sport 1.6
- Ryde Rival 19
- ▲ GHOST Disc Hub QR
- ▲ GHOST Disc Hub QR
- ▲ GHOST Light SP DC 1 27.2 mm
- ▲ GHOST VL 4212
- S / M / L
- Bosch Intuvia
- Bosch Performance Cruise (250 W)
- Bosch Power Pack 400 Wh

ANDASOL TREKKING

ENG

Whether you choose the traditional top-tubed frame or the Wave version for comfortable step-through, the Andasol series combines functionality with elegant design. It sets the standard for versatility, performance and electric mobility for all. The proven drive and suspension systems open up an entirely new mode of transportation, allowing you to enjoy nature almost effortlessly. Commuters can combine a relaxed ride to work with their daily workout routine and get the shopping done on the way home as an added bonus. The Andasol is environmentally friendly and inconspicuous, but this is no boring commuter.

GER

Unabhängig davon, ob du dich für den klassischen Diamant-Rahmen oder für die Wave-Version mit komfortablem Einstieg entscheidest – bei der Andasol-Serie trifft Funktionalität auf elegantes Design. Es setzt einen neuen Standard in Bezug auf Vielseitigkeit und Leistungsfähigkeit in der Elektromobilität. Antrieb und Fahrwerk eröffnen eine vollkommen neue Art der Fortbewegung und ein müheloses Naturerlebnis. Pendler kombinieren ihren Arbeitsweg mit einem Workout und erledigen auf dem Heimweg noch ganz nebenbei ihre Einkäufe. Das Andasol ist umweltschonend und unauffällig – aber es ist alles andere als ein Rad für Langweiler.



ANDASOL TREKKING 9

28"



- BLACK / BLACK
- ↳ Andasol Man Alloy
- ↳ RST Vogue Air TNL LO 60 mm
- ↳ Satori HL Stem UP2 Plus AHS 90 mm
- ↳ Satori Noir 660 mm 31.8 mm
- ↳ NuVinci Harmony H-Sync (automatic)
- -
- ↳ Miranda Delta 20
- ↳ Conti Drive 22
- ↳ Shimano XT Disc 180 mm SM-RT 66/68
- ↳ Schwalbe Marathon Almotion 50-622
- ↳ Ryde Rival 19
- ↳ Shimano XT QR
- ↳ NuVinci N380
- ↳ Satori Harmony LT2 27.2 mm
- ↳ GHOST 3050 HRN
- ↳ Tubus Racktime
- ↳ SKS CAB B 53 T
- ↳ Hebie 0661 X7
- ↳ Supernova E3 E-Bike
- ↳ Supernova E3 Tail Light 2
- ↳ S / M / L
- ↳ Bosch Intuvia
- ↳ Bosch Performance Cruise (250 W)
- ↳ Bosch Power Pack 500 Wh

ANDASOL 9 WAVE

28"



- BLACK / BLACK
- ↳ Andasol Wave Alloy
- ↳ RST Vogue Air TNL LO 60 mm
- ↳ Satori HL Stem UP2 Plus AHS 90 mm
- ↳ Satori Noirette Plus WS 660 mm 31.8 mm
- ↳ NuVinci Harmony
- ↳ NuVinci Harmony Advanced Controller
- ↳ Miranda Delta 15
- ↳ Esjot 18
- ↳ Shimano XT Disc 180 mm SM-RT 66/68
- ↳ Schwalbe Marathon Almotion 50-622
- ↳ Ryde Rival 19
- ↳ Shimano XT QR
- ↳ NuVinci N380
- ↳ Satori Harmony LT2 27.2 mm
- ↳ Selle Royal Milo Plus Lady
- ↳ Tubus Racktime
- ↳ SKS CAB B 53 T
- ↳ ergotec Doubleflex 2
- ↳ Supernova E3 E-Bike
- ↳ Supernova E3 Tail Light 2
- ↳ S / M
- ↳ Bosch Intuvia
- ↳ Bosch Active Cruise (250 W)
- ↳ Bosch Power Pack 500 Wh

ANDASOL TREKKING 9 MISS

28"



- BLACK / BLACK
- ↳ Andasol Miss Alloy
- ↳ RST Vogue Air TNL LO 60 mm
- ↳ Satori HL Stem UP2 Plus AHS 90 mm
- ↳ Satori Noirette Plus WS 660 mm 31.8 mm
- ↳ NuVinci Harmony H-Sync (automatic)
- -
- ↳ Miranda Delta 20
- ↳ Conti Drive 22
- ↳ Shimano XT Disc 180 mm SM-RT 66/68
- ↳ Schwalbe Marathon Almotion 50-622
- ↳ Ryde Rival 19
- ↳ Shimano XT QR
- ↳ NuVinci N380
- ↳ Satori Harmony LT2 27.2 mm
- ↳ GHOST 3050 DRN
- ↳ Tubus Racktime
- ↳ SKS CAB B 53 T
- ↳ Hebie 0661 X7
- ↳ Supernova E3 E-Bike
- ↳ Supernova E3 Tail Light 2
- ↳ S / M / L
- ↳ Bosch Intuvia
- ↳ Bosch Performance Cruise (250 W)
- ↳ Bosch Power Pack 500 Wh

ANDASOL TREKKING 6

28"



- BLACK / RED / GREY
- ↳ Andasol Man Alloy
- ↳ Suntour SF14 NEX-E25 LO 700C 63 mm
- ↳ Satori HL Stem UP2 Plus AHS 90 mm
- ↳ Satori Noir 660 mm 31.8 mm
- ↳ Shimano XT 10-Speed
- ↳ Shimano Deore SL
- ↳ Miranda Delta 18
- ↳ Shimano SLX 11-34
- ↳ Shimano 396 Disc 180 mm SM-RT 20
- ↳ Schwalbe Marathon 47-622
- ↳ Ryde Rival 19
- ↳ Shimano Deore QR
- ↳ Shimano Deore QR
- ↳ Satori Harmony LT2 27.2 mm
- ↳ GHOST 3050 HRN
- ↳ Tubus Racktime
- ↳ SKS CAB B 53 T
- ↳ Hebie 0661 X7
- ↳ AXA Blueline 30 E-Bike
- ↳ AXA Blueline
- ↳ S / M / L
- ↳ Bosch Intuvia
- ↳ Bosch Performance Cruise (250 W)
- ↳ Bosch Power Pack 500 Wh

ANDASOL TREKKING 6 MISS

28"



- BLACK / RED / GREY
- Andasol Miss Alloy
- ▲ Suntour SF14 NEX-E25 LO 700C 63 mm
- Satori HL Stem UP2 Plus AHS 90 mm
- Satori Noirette Plus WS 660 mm 31.8 mm
- Shimano XT 10-Speed
- Shimano Deore SL
- Miranda Delta 18
- Shimano SLX 11-34
- ▲ Shimano 396 Disc 180 mm SM-RT 20
- Schwalbe Marathon 47-622
- Ryde Rival 19
- ▲ Shimano Deore DR
- Shimano Deore DR
- Satori Harmony LT2 27.2 mm
- ▲ GHOST 3050 DRN
- Tubus Racktime
- SKS CAB B 53 T
- Hebie 0661 X7
- AXA BlueLine 30 E-Bike
- AXA BlueLine
- S/M/L
- Bosch Intuvia
- Bosch Performance Cruise (250 W)
- Bosch Power Pack 500 Wh

ANDASOL TREKKING 5 MISS

28"



- BLACK / GREEN / GREY
- Andasol Miss Alloy
- ▲ Suntour SF14 NEX-E25 LO 700C 63 mm
- Satori HL Stem UP2 Plus AHS 90 mm
- Satori Noirette Plus WS 660 mm 31.8 mm
- Shimano Alfine SL
- Miranda Delta 18
- Esjot 18
- ▲ Shimano 355 Disc 180 mm SM-RT 20
- Schwalbe Marathon 50-622
- Ryde Rival 19
- ▲ Shimano HB-M3050 QR
- Shimano Alfine Internal Geared Hub 8-Speed
- Satori Harmony LT2 27.2 mm
- ▲ GHOST 3050 DRN
- Tubus Racktime
- SKS CAB B 53 T
- Hebie 0661 X7
- AXA BlueLine 30 E-Bike
- AXA BlueLine
- S/M/L
- Bosch Intuvia
- Bosch Active Cruise (250 W)
- Bosch Power Pack 500 Wh

ANDASOL TREKKING 5

28"



- BLACK / GREEN / GREY
- Andasol Man Alloy
- ▲ Suntour SF14 NEX-E25 LO 700C 63 mm
- Satori HL Stem UP2 Plus AHS 90 mm
- Satori Noir 660 mm 31.8 mm
- Shimano Alfine SL
- Miranda Delta 18
- Esjot 18
- ▲ Shimano 355 Disc 180 mm SM-RT 20
- Schwalbe Marathon 50-622
- Ryde Rival 19
- ▲ Shimano HB-M3050 QR
- Shimano Alfine Internal Geared Hub 8-Speed
- Satori Harmony LT2 27.2 mm
- ▲ GHOST 3050 HRN
- Tubus Racktime
- SKS CAB B 53 T
- Hebie 0661 X7
- AXA BlueLine 30 E-Bike
- AXA BlueLine
- S/M/L
- Bosch Intuvia
- Bosch Active Cruise (250 W)
- Bosch Power Pack 500 Wh

ANDASOL WAVE 5

28"



- BLACK / GREEN / GREY
- Andasol Wave Alloy
- ▲ Suntour SF14 NEX-E25 LO 700C 63 mm
- Satori HL Stem UP2 Plus AHS 90 mm
- Satori Noirette Plus WS 660 mm 31.8 mm
- Shimano Alfine SL
- Miranda Delta 18
- Esjot 18
- ▲ Shimano 355 Disc 180 mm SM-RT 20
- Schwalbe Marathon 50-622
- Ryde Rival 19
- ▲ Shimano HB-M3050 QR
- Shimano Alfine Internal Geared Hub 8-Speed
- Satori Harmony LT2 27.2 mm
- ▲ Selle Royal Milo Plus Lady
- Tubus Racktime
- SKS CAB B 53 T
- ergotec Doubleflex 2
- AXA BlueLine 30 E-Bike
- AXA BlueLine
- S/M
- Bosch Intuvia
- Bosch Active Cruise (250 W)
- Bosch Power Pack 500 Wh

ANDASOL TREKKING 4

28"



- BLACK / BLUE / GREY
- Andasol Man Alloy
- ▲ RST Nova TnL 60 mm
- Satori HL Stem Compact 95 mm
- Satori Noir 660 mm 31.8 mm
- Shimano Deore 9-Speed
- Shimano Alivio SL
- Miranda Delta 18
- ▲ Shimano Alivio 11-34
- ▲ Tektro ACC 001 Disc 180 mm
- Schwalbe Marathon 50-622
- ☾ Ryde Rival 19
- ✚ GHOST Hub QR
- ✚ GHOST Hub QR
- Satori Harmony LT2 27.2 mm
- ▲ GHOST 3050 HRN
- ▽ Tubus Racktime
- ☒ SKS CAB B 53 T
- ☞ Hebie 0661 X7
- AXA BlueLine 30 E-Bike
- ☒ AXA BlueLine
- S / M / L
- ☐ Bosch Intuvia
- ☼ Bosch Active Cruise (250 W)
- Bosch Power Pack 400 Wh

ANDASOL TREKKING 4 MISS

28"



- BLACK / BLUE / GREY
- Andasol Miss Alloy
- ▲ RST Nova TnL 60 mm
- Satori HL Stem Compact 95 mm
- Satori Noirette Plus WS 660 mm 31.8 mm
- Shimano Deore 9-Speed
- Shimano Alivio SL
- Miranda Delta 18
- ▲ Shimano Alivio 11-34
- ▲ Tektro ACC 001 Disc 180 mm
- Schwalbe Marathon 50-622
- ☾ Ryde Rival 19
- ✚ GHOST Hub QR
- ✚ GHOST Hub QR
- Satori Harmony LT2 27.2 mm
- ▲ GHOST 3050 DRN
- ▽ Tubus Racktime
- ☒ SKS CAB B 53 T
- ☞ Hebie 0661 X7
- AXA BlueLine 30 E-Bike
- ☒ AXA BlueLine
- S / M / L
- ☐ Bosch Intuvia
- ☼ Bosch Active Cruise (250 W)
- Bosch Power Pack 400 Wh

SQUARE CROSS

ENG

It's a joy to present the first model of our new SQUARE platform. The Cross line offers the most versatile way to enjoy a whole array of experiences on only one bicycle. On the road, it glides along at almost road-bike-like speed, while off-road it offers the comfort, stability and puncture protection of a mountain bike. The riding position is well balanced and suitable for a Sunday spin or a quick ride after work. In creating such an outstanding bike we had to combine two special ingredients, a smartly engineered frame and a valuable components package. We're proud to introduce the new SQUARE Cross, a true crossover product.

GER

Wir freuen uns, das erste Modell unserer neuen SQUARE-Serie präsentieren zu können. Es ist ein extrem vielseitiges Rad, das seinem Fahrer eine Vielzahl von Möglichkeiten erschließt: Auf der Straße fährt es sich leichtgängig wie ein Rennrad und abseits geteuerter Wege bietet es den Komfort und die Stabilität eines Mountainbikes. Die Sitzposition ist gut ausbalanciert und gleichermaßen geeignet für eine entspannte Tour am Sonntag wie für eine schnelle Runde nach Feierabend. Für ein solch außergewöhnliches Fahrrad braucht es zwei Dinge: einen clever konstruierten Rahmen und hochwertige Komponenten. Wir sind stolz auf das SQUARE Cross – es ist ein echtes Crossover-Produkt, das das Beste aus den Welten der Rennräder und Mountainbikes in sich vereint.



SQUARE CROSS 7

28"



- BLACK/RED
- ▾ Square Cross
- ▮ RST VIVAir RL
- ▮ GHOST AS GH1 31.8 mm
- ▮ GHOST Rizer 660 mm 31.8 mm
- ▮ Shimano XT 10-Speed
- ▮ Shimano XT
- ▮ Shimano XT SL
- ▮ Shimano XT 48-36-26
- ▮ Shimano 11-34
- ▮ Shimano XT Disc
- ▮ Schwalbe Smart Sam
- ▮ Mach1 820 622 x 19
- ▮ Shimano XT QR
- ▮ Shimano XT QR
- ▮ GHOST Light SP DC 1 31.6 mm
- ▮ GHOST 3050 HRN
- ▮ S/M/L/XL

SQUARE CROSS 6

28"



- BLACK/ORANGE
- ▾ Square Cross
- ▮ RST VIVAir RL
- ▮ GHOST AS GH2 31.8 mm
- ▮ GHOST Rizer 660 mm 31.8 mm
- ▮ Shimano XT 10-Speed
- ▮ Shimano XT
- ▮ Shimano Deore SL
- ▮ Shimano XT 48-36-26
- ▮ Shimano 11-34
- ▮ Shimano 396 Disc 160 mm
- ▮ Schwalbe Smart Sam
- ▮ Mach1 820 622 x 19
- ▮ Shimano Deore
- ▮ Shimano Deore
- ▮ GHOST Light SP DC 1 31.6 mm
- ▮ GHOST 3050 HRN
- ▮ S/M/L/XL

SQUARE CROSS 7 MISS

28"



- BLACK/RED
- ▾ Square Cross Miss
- ▮ RST VIVAir RL
- ▮ GHOST AS GH1 31.8 mm
- ▮ GHOST Rizer 660 mm 31.8 mm
- ▮ Shimano XT 10-Speed
- ▮ Shimano XT
- ▮ Shimano XT SL
- ▮ Shimano XT 48-36-26
- ▮ Shimano 11-34
- ▮ Shimano XT Disc
- ▮ Schwalbe Smart Sam
- ▮ Mach1 820 622 x 19
- ▮ Shimano XT QR
- ▮ Shimano XT QR
- ▮ GHOST Light SP DC 1 31.6 mm
- ▮ GHOST 3050 DRN
- ▮ S/M/L/XL

SQUARE CROSS 6 MISS

28"



- BLACK/ORANGE
- ▾ Square Cross Miss
- ▮ RST VIVAir RL
- ▮ GHOST AS GH2 31.8 mm
- ▮ GHOST Rizer 660 mm 31.8 mm
- ▮ Shimano XT 10-Speed
- ▮ Shimano XT
- ▮ Shimano Deore SL
- ▮ Shimano XT 48-36-26
- ▮ Shimano 11-34
- ▮ Shimano 396 Disc 160 mm
- ▮ Schwalbe Smart Sam
- ▮ Mach1 820 622 x 19
- ▮ Shimano Deore
- ▮ Shimano Deore
- ▮ GHOST Light SP DC 1 31.6 mm
- ▮ GHOST 3050 DRN
- ▮ S/M/L/XL

SQUARE CROSS 5

28"



- BLACK / GREEN
- ▾ Square Cross
- ▮ SR Suntour SF14NEX RL 63 mm
- ▮ GHOST AS GH2 31.8 mm
- ▮ GHOST Rizer 660 mm 31.8 mm
- ▲ Shimano XT 9-Speed
- ▲ Shimano Alivio
- Shimano Deore SL
- ▲ Shimano 4010 48-36-26
- Shimano 11-32
- ▼ Shimano 355 Disc 160 mm SMRT 20
- ▲ Schwalbe XC Comp
- ▮ Mach1 820 622 x 19
- ▲ Shimano HB-RM 33 QR
- ▲ Shimano FH-RM 33 QR
- ▮ GHOST Light SP DC 1 31.6 mm
- ▮ GHOST 3050 HRN
- ▮ S / M / L / XL

SQUARE CROSS 4

28"



- BLACK / LIMEGREEN
- ▾ Square Cross
- ▲ ▮ RST Nova MLO 60 mm
- ▮ GHOST AS GH2 31.8 mm
- ▮ GHOST Rizer 660 mm 31.8 mm
- Shimano XT 9-Speed
- ▲ Shimano Acera
- ▲ Shimano Acera
- ▲ Shimano FC 371 48-36-26
- Shimano 11-32
- ▼ Shimano 355 Disc 160 mm
- ▲ Schwalbe XC Comp
- ▮ Mach1 820 622 x 19
- ▲ Shimano HB-RM 33 QR
- ▲ Shimano FH-RM 33 QR
- ▮ GHOST Light SP DC 1 31.6 mm
- ▮ GHOST 3050 HRN
- ▮ S / M / L / XL

SQUARE CROSS 5 MISS

28"



- BLACK / GREEN
- ▾ Square Cross Miss
- ▮ SR Suntour SF14NEX RL 63mm
- ▮ GHOST AS GH2 31.8 mm
- ▮ GHOST Rizer 660 mm 31.8 mm
- ▲ Shimano XT 9-Speed
- ▲ Shimano Alivio
- Shimano Deore SL
- ▲ Shimano 4010 48-36-26
- Shimano 11-32
- ▼ Shimano 355 Disc 160 mm SMRT 20
- ▲ Schwalbe XC Comp
- ▮ Mach1 820 622 x 19
- ▲ Shimano HB-RM 33 QR
- ▲ Shimano FH-RM 33 QR
- ▮ GHOST Light SP DC 1 31.6 mm
- ▮ GHOST 3050 DRN
- ▮ S / M / L / XL

SQUARE CROSS 4 MISS

28"



- BLACK / LIMEGREEN
- ▾ Square Cross Miss
- ▲ ▮ RST Nova MLO 60 mm
- ▮ GHOST AS GH2 31.8 mm
- ▮ GHOST Rizer 660 mm 31.8 mm
- Shimano XT 9-Speed
- ▲ Shimano Acera
- ▲ Shimano Acera
- ▲ Shimano FC 371 48-36-26
- Shimano 11-32
- ▼ Shimano 355 Disc 160 mm
- ▲ Schwalbe XC Comp
- ▮ Mach1 820 622 x 19
- ▲ Shimano HB-RM 33 QR
- ▲ Shimano FH-RM 33 QR
- ▮ GHOST Light SP DC 1 31.6 mm
- ▮ GHOST 3050 DRN
- ▮ S / M / L / XL

SQUARE CROSS 3

28"



- BLACK/BLUE
- ▾ Square Cross
- ▲ RST Neon MLO 60 mm ▼
- ▾ GHOST AS GH2 31.8 mm
- ▾ GHOST Rizer 660 mm 31.8 mm
- ▲ Shimano Acera 9-Speed ▼
- ▲ Shimano Altus ▼
- ▲ Shimano 370 SL ▼
- ▾ Shimano FC 371 48-36-26 ▼
- ▾ Shimano 11-32 ▼
- ▲ Tektro ACC 001 Disc 160 mm ▼
- ▾ Schwalbe XC Comp
- ▾ Mach1 820 622 x 19
- ▾ GHOST Disc Hub QR
- ▾ GHOST Disc Hub QR
- ▾ GHOST Light SP DC 1 31.6 mm
- ▾ GHOST 3050 HRN
- ▾ S/M/L/XL

SQUARE CROSS 2

28"



- BLACK/LIGHTBLUE
- ▾ Square Cross
- ▲ RST Neon T 60 mm
- ▾ GHOST AS GH2 31.8 mm
- ▾ GHOST Rizer 660 mm 31.8 mm
- ▲ Shimano Acera 8-Speed
- ▲ Shimano 191
- ▲ Shimano TX-800
- ▾ Shimano FC 131 48-38-28
- ▾ Shimano 11-30
- ▲ Tektro V-Brake
- ▾ Schwalbe XC Comp
- ▾ Mach1 / 810 622 x 19
- ▾ GHOST QR
- ▾ GHOST QR
- ▾ GHOST Light SP DC 1 31.6 mm
- ▾ GHOST 3050 HRN
- ▾ S/M/L/XL

SQUARE CROSS 3 MISS

28"



- BLACK/BLUE
- ▾ Square Cross Miss
- ▲ RST Neon MLO 60 mm ▼
- ▾ GHOST AS GH2 31.8 mm
- ▾ GHOST Rizer 660 mm 31.8 mm
- ▲ Shimano Acera 9-Speed ▼
- ▲ Shimano Altus ▼
- ▲ Shimano 370 SL ▼
- ▾ Shimano FC 371 48-36-26 ▼
- ▾ Shimano 11-32 ▼
- ▲ Tektro ACC 001 Disc 160 mm ▼
- ▾ Schwalbe XC Comp
- ▾ Mach1 820 622 x 19
- ▾ GHOST Disc Hub QR
- ▾ GHOST Disc Hub QR
- ▾ GHOST Light SP DC 1 31.6 mm
- ▾ GHOST 3050 DRN
- ▾ S/M/L/XL

SQUARE CROSS 2 MISS

28"



- BLACK/LIGHTBLUE
- ▾ Square Cross Miss
- ▲ RST Neon T 60 mm
- ▾ GHOST AS GH2 31.8 mm
- ▾ GHOST Rizer 660 mm 31.8 mm
- ▲ Shimano Acera 8-Speed
- ▲ Shimano 191
- ▲ Shimano TX-800
- ▾ Shimano FC 131 48-38-28
- ▾ Shimano 11-30
- ▲ Tektro V-Brake
- ▾ Schwalbe XC Comp
- ▾ Mach1 / 810 622 x 19
- ▾ GHOST QR
- ▾ GHOST QR
- ▾ GHOST Light SP DC 1 31.6 mm
- ▾ GHOST 3050 DRN
- ▾ S/M/L/XL

SQUARE CROSS X

ENG

For riders willing to ride farther and longer there's always something Xtra - The "X" version. Whether facing eXtreme weather conditions or impending darkness, it's no problem with eXtras like fenders and lights. With all its features, you'll always reach home safely and conveniently on the Cross X. And when light weight is the priority of the day, you can easily remove the attachments in no time flat.

GER

Länger, weiter - die X-Version ist für alle, die noch mehr wollen. Die Vollausstattung mit Schutzblechen und hochwertiger Beleuchtung nimmt schlechtem Wetter oder einbrechender Dämmerung den Schrecken. Mit diesem Rad kommst du immer sicher und bequem Zuhause an. Und wenn es dann doch einmal auf das Gewicht ankommt, kannst du sämtliche Anbauteile im Handumdrehen entfernen.



●	BLACK/LIMEGREEN
🔗	Square Cross X
🏠	SR Suntour SF14NEX DS
📏	GHOST AS GH2 31.8 mm
📏	GHOST Rizer 660 mm 31.8 mm
🔗	Shimano Deore 9-Speed
🔗	Shimano 370
🔗	Shimano Acera
🔗	Shimano FC 371 48-36-26
🔗	Shimano 11-32
🔗	Shimano 355 Disc 160 mm SMRT 20
🔗	Schwalbe XC Comp
🔗	Mach1 820 622 x 19
🔗	Shimano Hub Dynamo
🔗	Shimano FH-RM 33 DR
🔗	GHOST Light SP DC 1 31.6 mm
🔗	GHOST 3050 HRN
🔗	SKS
🔗	AXA Echo Switch An-/Aus-Schalter
🔗	Busch & Müller IX-Post
🔗	S/M/L/XL



SQUARE CROSS X 4

28"

●	BLACK/LIMEGREEN
🔗	Square Cross X Miss
🏠	SR Suntour SF14NEX DS
📏	GHOST AS GH2 31.8 mm
📏	GHOST Rizer 660 mm 31.8 mm
🔗	Shimano Deore 9-Speed
🔗	Shimano 370
🔗	Shimano Acera
🔗	Shimano FC 371 48-36-26
🔗	Shimano 11-32
🔗	Shimano 355 Disc 160 mm SMRT 20
🔗	Schwalbe XC Comp
🔗	Mach1 820 622 x 19
🔗	Shimano Hub Dynamo
🔗	Shimano FH-RM 33 DR
🔗	GHOST Light SP DC 1 31.6 mm
🔗	GHOST 3050 DRN
🔗	SKS
🔗	AXA Echo Switch An-/Aus-Schalter
🔗	Busch & Müller IX-Post
🔗	S/M/L/XL



SQUARE CROSS X 4 MISS

28"

SQUARE CROSS X 2

28"



●	BLACK/LIGHTBLUE
🔗	Square Cross X
🏠	SR Suntour SF14NEX DS
🔧	GHOST AS GH2 31.8 mm
📏	GHOST Rizer 660 mm 31.8 mm
▲	Shimano Altus 8-Speed
▲	Shimano 191
▲	Shimano 310 SL
▲	Shimano FC 131 48-38-28
🌀	Shimano 11-30
▲	Tektro ACC 001 Disc 160 mm
🦋	Schwalbe XC Comp
🌙	Mach1 820 622 x 19
⚙️	Shimano Hub Dynamo
⚙️	GHOST QR
🔧	GHOST Light SP DC 1 31.6 mm
🏠	GHOST 3050 HRN
🏠	SKS
🔊	AXA Echo Switch An-/Aus-Schalter
🔧	Busch & Müller IX-Post
—	S/M/L/XL

SQUARE TREKKING

ENG

This all rounder shares the same basic frame of the SQUARE Cross, but it offers even more options and unique technical features such as the GHOST central suspension fork, integrated cable routing, super-stiff fenders, and a fully integrated rack carrier which accommodates all common panniers. All frames in this line feature our revolutionary sandwich belt-drive-ready dropout, enabling you to start simple and upgrade over time as you choose. The high-quality equipment guarantees years of use for both every-day commuting and weekend excursions.

GER

Dieser Allrounder basiert auf demselben Rahmenkonzept wie das SQUARE Cross, bietet aber mehr Optionen und innovative Features – zum Beispiel die GHOST Central-Suspension-Fork, innenverlegte Züge, extrasteife Schutzbleche und einen komplett integrierten Gepäckträger für alle gängigen Fahrradtaschen. Ab dem SQUARE Trekking 6 aufwärts ist es zudem mit der hochwertigen Supernova-Beleuchtung ausgestattet. Egal für welches Modell du dich entscheidest, die Bikes der SQUARE Trekking Serie werden dich über viele Jahre und Tausende Kilometer hinweg begleiten – sei es beim täglichen Pendeln oder bei langen Touren am Wochenende.



SQUARE CROSS X 2 MISS

28"



●	BLACK/LIGHTBLUE
🔗	Square Cross X Miss
🏠	SR Suntour SF14NEX DS
🔧	GHOST AS GH2 31.8 mm
📏	GHOST Rizer 660 mm 31.8 mm
▲	Shimano Altus 8-Speed
▲	Shimano 191
▲	Shimano 310 SL
▲	Shimano FC 131 48-38-28
🌀	Shimano 11-30
▲	Tektro ACC 001 Disc 160 mm
🦋	Schwalbe XC Comp
🌙	Mach1 820 622 x 19
⚙️	Shimano Hub Dynamo
⚙️	GHOST QR
🔧	GHOST Light SP DC 1 31.6 mm
🏠	GHOST 3050 DRN
🏠	SKS
🔊	AXA Echo Switch An-/Aus-Schalter
🔧	Busch & Müller IX-Post
—	S/M/L/XL

SQUARE TREKKING 8

28"



- BLACK / GREY
- 🔧 Square Trekking
- 🏠 GHOST Central-Suspension-Fork ▼
- 🔧 GHOST Stem UP2 Plus AHS 31.8 mm
- 📏 GHOST Rise 23 660 mm 31.8 mm
- 🦋 Shimano XT 10-Speed ●
- 🦋 Shimano XT ●
- ⚙️ Shimano XT SL ●
- 🦋 Shimano XT 48-36-26 ●
- 🎯 Shimano 11-34 ●
- 🌀 Shimano Deore Disc 180 mm SMRT 64 ▼
- 🌀 Michelin PROTEK 37-622
- 📏 Mach1 820 622 x 19
- ⚙️ Shimano Hub Dynamo XT ▼
- ⚙️ Shimano XT ●
- 🔧 GHOST LT 31.6 x 300 mm
- 🔧 GHOST 3050 HRN
- 🏠 GHOST
- 🏠 GHOST / Wingee
- 🔧 Hebie
- 🔦 Supernova E3 Pure 3
- 🔦 Supernova E3 Tail Light 2
- S / M / L / XL

SQUARE TREKKING 7

28"



- BLACK / SILVER
- 🔧 Square Trekking
- 🏠 SR Suntour SF14NEX HLO-DS-700 50 mm ▼
- 🔧 GHOST Stem UP2 Plus AHS 31.8 mm
- 📏 GHOST Rise 23 660 mm 31.8 mm
- 🦋 Conti Drive System ●
- 🦋 - ●
- ⚙️ Shimano Alfine SL ●
- 🦋 Miranda ●
- 🎯 Conti Drive ●
- 🌀 Shimano 355 Disc 160 mm SMRT 20 ▲
- 🌀 Michelin PROTEK 40-622
- 📏 Mach1 820 622 x 19
- ⚙️ Shimano Hub Dynamo ▲
- ⚙️ Shimano Alfine Internal Gear Hub 8-Speed ▼
- 🔧 GHOST LT 31.6 x 300 mm
- 🔧 GHOST 3050 HRN
- 🏠 GHOST
- 🏠 GHOST / Wingee
- 🔧 Hebie
- 🔦 B&M Lumotec Mini
- 🔦 Herrmans H-Trace
- S / M / L / XL

SQUARE TREKKING 8 MISS

28"



- BLACK / GREY
- 🔧 Square Trekking Miss
- 🏠 GHOST Central-Suspension-Fork ▼
- 🔧 GHOST Stem UP2 Plus AHS 31.8 mm
- 📏 GHOST 660 mm 31.8 mm
- 🦋 Shimano XT 10-Speed ●
- 🦋 Shimano XT ●
- ⚙️ Shimano XT SL ●
- 🦋 Shimano XT 48-36-26 ●
- 🎯 Shimano 11-34 ●
- 🌀 Shimano Deore Disc 180 mm SMRT 64 ▼
- 🌀 Michelin PROTEK 37-622
- 📏 Mach1 820 622 x 19
- ⚙️ Shimano Hub Dynamo XT ▼
- ⚙️ Shimano XT ●
- 🔧 GHOST LT 31.6 x 300 mm
- 🔧 GHOST 3050 DRN
- 🏠 GHOST
- 🏠 GHOST / Wingee
- 🔧 Hebie
- 🔦 Supernova E3 Pure 3
- 🔦 Supernova E3 Tail Light 2
- S / M / L / XL

SQUARE TREKKING 7 MISS

28"



- BLACK / SILVER
- 🔧 Square Trekking Miss
- 🏠 SR Suntour SF14NEX HLO-DS-700 50 mm ▼
- 🔧 GHOST Stem UP2 Plus AHS 31.8 mm
- 📏 GHOST 660 mm 31.8 mm
- 🦋 Conti Drive System ●
- 🦋 - ●
- ⚙️ Shimano Alfine SL ●
- 🦋 Miranda ●
- 🎯 Conti Drive ●
- 🌀 Shimano 355 Disc 160 mm SMRT 20 ▲
- 🌀 Michelin PROTEK 40-622
- 📏 Mach1 820 622 x 19
- ⚙️ Shimano Hub Dynamo ▲
- ⚙️ Shimano Alfine Internal Gear Hub 8-Speed ▼
- 🔧 GHOST LT 31.6 x 300 mm
- 🔧 GHOST 3050 DRN
- 🏠 GHOST
- 🏠 GHOST / Wingee
- 🔧 Hebie
- 🔦 B&M Lumotec mini
- 🔦 Herrmans H-Trace
- S / M / L / XL

SQUARE TREKKING 6

28"



- BLACK/RED
- ▾ Square Trekking
- ▲ SR Suntour NCX D LO 700C Air 50 mm ▼
- ▾ GHOST Stem UP2 Plus AHS 31.8 mm
- ▾ GHOST Rise 23 660 mm 31.8 mm
- Shimano XT 10-Speed ▼
- ▾ Shimano Deore ▼
- ▾ Shimano Deore SL ▼
- Shimano Deore 48-36-26 ▼
- Shimano 11-34
- ▾ Shimano 396 Disc 160 mm ▼
- Michelin PROTEK 40-622
- ▾ Mach1 820 622 x 19
- ▾ Shimano Hub Dynamo
- ▲ Shimano FH-RM 33 QR
- ▾ GHOST LT 31.6 x 300 mm
- ▾ GHOST 3050 HRN
- ▾ GHOST
- ▾ GHOST / Wingee
- ▾ Hebie
- ▾ Supernova E3 Pure 3
- ▾ Supernova E3 Tail Light 2
- ▾ S/M/L/XL

SQUARE TREKKING 5

28"



- BLACK/ORANGE
- ▾ Square Trekking
- ▲ SR Suntour SF14NEX HLO-DS-700 50mm
- ▾ GHOST Stem UP2 Plus AHS, 31.8
- ▾ GHOST Rise 23, 660 mm 31.8
- ▲ Shimano XT 9-Speed
- ▲ Shimano 370
- ▲ Shimano Alivio
- ▲ Shimano FC 4010 48-36-26
- Shimano 11-32
- ▲ Shimano 355 Disc 160 mm SMRT 20
- Michelin PROTEK 40-622
- ▾ Mach1 820 622 x 19
- ▾ Shimano Hub Dynamo
- ▾ Shimano FH-RM 33 QR
- ▾ GHOST LT 31.6 x 300 mm
- ▾ GHOST 3050 HRN
- ▾ GHOST
- ▾ GHOST / Wingee
- ▾ Hebie
- ▾ B&M Lumotec mini
- ▾ Herrmans H-Trace
- ▾ S/M/L/XL

SQUARE TREKKING 6 MISS

28"



- BLACK/RED
- ▾ Square Trekking Miss
- ▲ SR Suntour NCX D LO 700C Air 50 mm ▼
- ▾ GHOST Stem UP2 Plus AHS 31.8 mm
- ▾ GHOST 660 mm 31.8 mm
- Shimano XT 10-Speed ▼
- ▾ Shimano Deore ▼
- ▾ Shimano Deore SL ▼
- Shimano Deore 48-36-26 ▼
- Shimano 11-34
- ▾ Shimano 396 Disc 160 mm ▼
- Michelin PROTEK 40-622
- ▾ Mach1 820 622 x 19
- ▾ Shimano Hub Dynamo
- ▲ Shimano FH-RM 33 QR
- ▾ GHOST LT 31.6 x 300 mm
- ▾ GHOST 3050 DRN
- ▾ GHOST
- ▾ GHOST / Wingee
- ▾ Hebie
- ▾ Supernova E3 Pure 3
- ▾ Supernova E3 Tail Light 2
- ▾ S/M/L/XL

SQUARE TREKKING 5 MISS

28"



- BLACK/ORANGE
- ▾ Square Trekking Miss
- ▲ SR Suntour SF14NEX HLO-DS-700 50 mm
- ▾ GHOST Stem UP2 Plus AHS 31.8 mm
- ▾ GHOST 660 mm 31.8 mm
- ▲ Shimano XT 9-Speed
- ▲ Shimano 370
- ▲ Shimano Alivio
- ▲ Shimano FC 4010 48-36-26
- Shimano 11-32
- ▲ Shimano 355 Disc 160 mm SMRT 20
- Michelin PROTEK 40-622
- ▾ Mach1 820 622 x 19
- ▾ Shimano Hub Dynamo
- ▾ Shimano FH-RM 33 QR
- ▾ GHOST LT 31.6 x 300 mm
- ▾ GHOST 3050 DRN
- ▾ GHOST
- ▾ GHOST / Wingee
- ▾ Hebie
- ▾ B&M Lumotec Mini
- ▾ Herrmans H-Trace
- ▾ S/M/L/XL

SQUARE TREKKING 4

28"



- BLACK / GREEN
- 🔧 Square Trekking
- 🏠 SR Suntour SF14NEX HLO-DS-700 50 mm ▼
- 🔧 GHOST Stem Compact 31.8 mm
- 📏 GHOST Rise 23 660 mm 31.8 mm
- 🦋 Shimano Deore 9-Speed ▼
- 🦋 Shimano Acera ▼
- ⚙️ Shimano Acera ▲
- 🦋 Shimano FC 371 48-36-26 ▲
- 🌀 Shimano 11-32
- ⚙️ Shimano 355 Disc 160 mm SMRT 20 ●
- 🌀 Michelin PROTEK 40-622
- 📏 Mach1 820 622 x 19
- ⚙️ Shimano Hub Dynamo
- 🦋 Shimano FH-RM 33 QR ●
- 🔧 GHOST LT 2 31.6 x 300 mm
- 🔧 GHOST 3050 HRN
- 🔧 GHOST
- 🔧 GHOST / Wingee
- 🔧 Hebie
- 🔊 AXA Echo Switch An- / Aus-Schalter
- 🔊 Herrmans H-Trace
- ➔ S / M / L / XL

SQUARE TREKKING 3

28"



- BLACK / LIMEGREEN
- 🔧 Square Trekking
- 🏠 SR Suntour SF13 CR-7V A 700C 40 mm ▲
- 🔧 GHOST Stem Compact 31.8 mm
- 📏 GHOST Rise 23 660 mm 31.8 mm
- 🦋 Shimano Alivio 9-Speed ▼
- 🦋 Shimano 191 ▲
- ⚙️ Shimano Acera ▼
- 🦋 Shimano FC 371 48-36-26 ▼
- 🌀 Shimano 11-32
- ⚙️ Magura HS 11 ●
- 🌀 Michelin PROTEK 40-622
- 📏 Mach1 / 810 622 x 19
- ⚙️ Shimano Hub Dynamo
- 🦋 GHOST QR ●
- 🔧 GHOST LT 2 31.6 x 300 mm
- 🔧 GHOST 3050 HRN
- 🔧 GHOST
- 🔧 GHOST / Wingee
- 🔧 Hebie
- 🔊 AXA Echo Switch An- / Aus-Schalter
- 🔊 Herrmans H-Trace
- ➔ S / M / L / XL

SQUARE TREKKING 4 MISS

28"



- BLACK / GREEN
- 🔧 Square Trekking Miss
- 🏠 SR Suntour SF14NEX HLO-DS-700 50 mm ▼
- 🔧 GHOST Stem Compact 31.8 mm
- 📏 GHOST 660 mm 31.8 mm
- 🦋 Shimano Deore 9-Speed ▼
- 🦋 Shimano Acera ▼
- ⚙️ Shimano Acera ▲
- 🦋 Shimano FC 371 48-36-26 ▲
- 🌀 Shimano 11-32
- ⚙️ Shimano 355 Disc 160 mm SMRT 20 ●
- 🌀 Michelin PROTEK 40-622
- 📏 Mach1 820 622 x 19
- ⚙️ Shimano Hub Dynamo
- 🦋 Shimano FH-RM 33 QR ●
- 🔧 GHOST LT 2 31.6 x 300 mm
- 🔧 GHOST 3050 DRN
- 🔧 GHOST
- 🔧 GHOST / Wingee
- 🔧 Hebie
- 🔊 AXA Echo Switch An- / Aus-Schalter
- 🔊 Herrmans H-Trace
- ➔ S / M / L / XL

SQUARE TREKKING 3 MISS

28"



- BLACK / LIMEGREEN
- 🔧 Square Trekking Miss
- 🏠 SR Suntour SF13 CR-7V A 700C 40 mm ▲
- 🔧 GHOST Stem Compact 31.8 mm
- 📏 GHOST 660 mm 31.8 mm
- 🦋 Shimano Alivio 9-Speed ▼
- 🦋 Shimano 191 ▲
- ⚙️ Shimano Acera ▼
- 🦋 Shimano FC 371 48-36-26 ▼
- 🌀 Shimano 11-32
- ⚙️ Magura HS 11 ●
- 🌀 Michelin PROTEK 40-622
- 📏 Mach1 / 810 622 x 19
- ⚙️ Shimano Hub Dynamo
- 🦋 GHOST QR ●
- 🔧 GHOST LT 2 31.6 x 300 mm
- 🔧 GHOST 3050 DRN
- 🔧 GHOST
- 🔧 GHOST / Wingee
- 🔧 Hebie
- 🔊 AXA Echo Switch An- / Aus-Schalter
- 🔊 Herrmans H-Trace
- ➔ S / M / L / XL

SQUARE TREKKING 2

28"



- BLACK/BLUE
- ▾ Square Trekking
- ▮ SR Suntour SF14NEX DS-700C 50 mm
- ▮ GHOST Stem Compact 31.8 mm
- ▮ GHOST Rise 23 660 mm 31.8 mm
- ▲ Shimano Altus 8-Speed
- ▮ Shimano 191
- ▲ Shimano 310 SL
- ▲ Shimano FC 311 48-38-28
- ◎ Shimano 12-32
- Tektro ACC 001 Disc 160 mm
- Michelin PROTEK 40-622
- ▮ Mach1 820 622 x 19
- ▮ Shimano Hub Dynamo
- GHOST Disc QR
- ▮ GHOST LT 31.6 x 300 mm
- ▮ GHOST 3050 HRN
- ▮ GHOST
- ▮ GHOST/Wingee
- ▮ Hebie
- ▮ AXA Echo Switch An-/Aus-Schalter
- ▮ Herrmans H-Trace
- ▮ S/M/L/XL

- BLACK/LIGHTBLUE
- ▾ Square Trekking
- ▲ ▮ SR Suntour SF13 CR-7V 700C 40 mm
- ▮ GHOST Stem Compact 31.8 mm
- ▮ GHOST Rise 23 660 mm 31.8 mm
- ▮ Shimano Altus 8-Speed
- ▮ Shimano Altus
- ▮ Shimano STEF S1
- ▮ Shimano FC 171 48-38-28
- ◎ Shimano 12-32
- ▲ Tektro V-Brake
- Michelin PROTEK 40-622
- ▮ Mach1 / 810 622 x 19
- ▮ Shimano Hub Dynamo
- GHOST QR
- ▮ GHOST LT 2 31.6 x 300 mm
- ▮ GHOST 3050 HRN
- ▮ GHOST
- ▮ GHOST/Wingee
- ▮ Hebie
- ▮ AXA Echo Switch An-/Aus-Schalter
- ▮ Herrmans H-Trace
- ▮ S/M/L/XL

SQUARE TREKKING 1

28"



SQUARE TREKKING 2 MISS

28"



- BLACK/BLUE
- ▾ Square Trekking Miss
- ▮ SR Suntour SF14NEX DS-700C 50 mm
- ▮ GHOST Stem Compact 31.8 mm
- ▮ GHOST 660 mm 31.8 mm
- ▲ Shimano Altus 8-Speed
- ▮ Shimano 191
- ▲ Shimano 310 SL
- ▲ Shimano FC 311 48-38-28
- ◎ Shimano 12-32
- Tektro ACC 001 Disc 160 mm
- Michelin PROTEK 40-622
- ▮ Mach1 820 622 x 19
- ▮ Shimano Hub Dynamo
- GHOST Disc QR
- ▮ GHOST LT 2 31.6 x 300 mm
- ▮ GHOST 3050 DRN
- ▮ GHOST
- ▮ GHOST/Wingee
- ▮ Hebie
- ▮ AXA Echo Switch An-/Aus-Schalter
- ▮ Herrmans H-Trace
- ▮ S/M/L/XL

- BLACK/LIGHTBLUE
- ▾ Square Trekking Miss
- ▲ ▮ SR Suntour SF13 CR-7V 700C 40 mm
- ▮ GHOST Stem Compact 31.8 mm
- ▮ GHOST 660 mm 31.8 mm
- ▮ Shimano Altus 8-Speed
- ▮ Shimano Altus
- ▮ Shimano STEF S1
- ▮ Shimano FC 171 48-38-28
- ◎ Shimano 12-32
- ▲ Tektro V-Brake
- Michelin PROTEK 40-622
- ▮ Mach1 / 810 622 x 19
- ▮ Shimano Hub Dynamo
- GHOST QR
- ▮ GHOST LT 2 31.6 x 300 mm
- ▮ GHOST 3050 DRN
- ▮ GHOST
- ▮ GHOST/Wingee
- ▮ Hebie
- ▮ AXA Echo Switch An-/Aus-Schalter
- ▮ Herrmans H-Trace
- ▮ S/M/L/XL

SQUARE TREKKING 1 MISS

28"



SQUARE URBAN

ENG

It's the ultimate urban cruiser, a one of a kind, the SQUARE Urban. It wraps all the advanced features of Cross and Trekking into a minimalistic, stylishly tonal package. Perhaps the only issue will be choosing bike bags to match your outfit. See you on the Square.

GER

Dies ist der ultimative Urban-Cruiser für die Stadt. Das SQUARE Urban verbindet die Features von Cross- und Trekkingrädern zu einem stylish-minimalistischen Gesamtpaket. Es ist ein Fahrrad für Design-Liebhaber und der perfekte Begleiter für deinen ganz großen Auftritt.



- GREY/ORANGE
- 🚲 Square Urban
- 🏠 GHOST Alloy Rigid
- 🔧 GHOST AS GH2 31.8 mm
- 📏 GHOST Low Rizer 680 mm 31.8 mm
- 🔗 Conti Drive System
- 📏 -
- ⚙️ Shimano Alfine SL
- 🚲 Miranda Beta
- 🎯 Conti Drive
- ⚙️ Shimano 355 Disc 160 mm SMRT 20
- 🌀 Schwalbe Kojak
- 📏 Mach1 820 622 x 19
- ⚙️ Shimano HB-RM 33 QR
- ⚙️ Shimano Alfine Internal Gear Hub 8-Speed
- 🔧 GHOST Light DC1 31.6 mm
- 🔧 GHOST 2059 HRN
- 🚲 GHOST
- 🚲 GHOST/Wingee
- 🔧 Hebie
- 📏 S/M/L/XL

SQUARE URBAN 6

28"



- GREY/ORANGE
- 🚲 Square Urban Miss
- 🏠 GHOST Alloy Rigid
- 🔧 GHOST AS GH2 31.8 mm
- 📏 GHOST Low Rizer 680 mm 31.8 mm
- 🔗 Conti Drive System
- 📏 -
- ⚙️ Shimano Alfine SL
- 🚲 Miranda Beta
- 🎯 Conti Drive
- ⚙️ Shimano 355 Disc 160 mm SMRT 20
- 🌀 Schwalbe Kojak
- 📏 Mach1 820 622 x 19
- ⚙️ Shimano HB-RM 33 QR
- ⚙️ Shimano Alfine Internal Gear Hub 8-Speed
- 🔧 GHOST Light DC1 31.6 mm
- 🔧 GHOST 2059 DRN
- 🚲 GHOST
- 🚲 GHOST/Wingee
- 🔧 Hebie
- 📏 S/M/L/XL

SQUARE URBAN 6 MISS

28"



SQUARE URBAN 4

28"



- GREY/LIMEGREEN
- ▾ Square Urban
- ┆ GHOST Alloy Rigid
- ▣ GHOST AS GH2 31.8 mm
- ┄ GHOST Low Rizer 680 mm 31.8 mm
- ⚙ -
- ┆ -
- ⊕ Shimano Alfine SL
- Truvativ E400 Single 38
- ⊙ Esjot 18
- ⊗ Shimano 355 Disc 160 mm SMRT 20
- ⊗ Schwalbe Kojak 35-622
- ☾ Mach1 820 622 x 19
- ⊕ Shimano HB-RM 33 QR
- ⊕ Shimano Alfine Internal Gear Hub 8-Speed
- ┆ GHOST Light DC1 31.6 mm
- ▲ GHOST 2059 HRN
- ▽ GHOST
- ┆ GHOST/Wingee
- ┆ Hebie
- ┆ S/M/L/XL

SQUARE URBAN 2

28"



- GREY/BLUE
- ▾ Square Urban
- ┆ GHOST Alloy Rigid
- ▣ GHOST AS GH2 31.8 mm
- ┄ GHOST Low Rizer 680 mm 31.8 mm
- ⚙ Shimano Deore 9-Speed
- ┆ Shimano Acera
- ⊕ Shimano Acera
- Shimano FC 371 48-36-26
- ⊙ Shimano 11-32
- ▲ Tektro ACC 001 Disc 160 mm
- ⊗ Schwalbe Kojak 35-622
- ☾ Mach1 820 622 x 19
- ⊕ GHOST Disc QR
- ⊕ GHOST Disc QR
- ┆ GHOST Light DC1 31.6 mm
- ▲ GHOST 2059 HRN
- ▽ GHOST
- ┆ GHOST/Wingee
- ┆ Hebie
- ┆ S/M/L/XL

SQUARE URBAN 4 MISS

28"



- GREY/LIMEGREEN
- ▾ Square Urban Miss
- ┆ GHOST Alloy Rigid
- ▣ GHOST AS GH2 31.8 mm
- ┄ GHOST Low Rizer 680 mm 31.8 mm
- ⚙ -
- ┆ -
- ⊕ Shimano Alfine SL
- Truvativ E400 Single 38
- ⊙ Esjot 18
- ⊗ Shimano 355 Disc 160 mm SMRT 20
- ⊗ Schwalbe Kojak 35-622
- ☾ Mach1 820 622 x 19
- ⊕ Shimano HB-RM 33 QR
- ⊕ Shimano Alfine Internal Gear Hub 8-Speed
- ┆ GHOST Light DC1 31.6 mm
- ▲ GHOST 2059 DRN
- ▽ GHOST
- ┆ GHOST/Wingee
- ┆ Hebie
- ┆ S/M/L/XL

SQUARE URBAN 2 MISS

28"



- GREY/BLUE
- ▾ Square Urban Miss
- ┆ GHOST Alloy Rigid
- ▣ GHOST AS GH2 31.8 mm
- ┄ GHOST Low Rizer 680 mm 31.8 mm
- ⚙ Shimano Deore 9-Speed
- ┆ Shimano Acera
- ⊕ Shimano Acera
- Shimano FC 371 48-36-26
- ⊙ Shimano 11-32
- ▲ Tektro ACC 001 Disc 160 mm
- ⊗ Schwalbe Kojak 35-622
- ☾ Mach1 820 622 x 19
- ⊕ GHOST Disc QR
- ⊕ GHOST Disc QR
- ┆ GHOST Light DC1 31.6 mm
- ▲ GHOST 2059 DRN
- ▽ GHOST
- ┆ GHOST/Wingee
- ┆ Hebie
- ┆ S/M/L/XL

SQUARE URBAN X

ENG

You want more options and more style. When commuting to work early mornings in the rain or trying to get around town safely at night, choose an Xtraordinary bike for your Xtreme situations. With light by Supernova, Belt drive by Continental, Wingee fenders, smart urban mobility solutions by IXOW and COBI multimedia interface integrating your smart phone, SQUARE Urban X is your ultimate Urban riding system.

GER

Du willst noch mehr Optionen und noch mehr Style? Wenn du auch frühmorgens im Regen zur Arbeit oder nachts sicher durch die Stadt fahren willst, solltest du dich für dieses außergewöhnliche Rad entscheiden. Die Beleuchtung kommt von Supernova, der Riemenantrieb von Continental und die Schutzbleche von Wingee. Optional ist es zusätzlich mit innovativen Komponenten von IXOW und der COBI Multimedia-Schnittstelle ausgestattet, die dein Smartphone ins Fahrrad integriert. Das SQUARE Urban X ist das ultimative Fortbewegungsmittel für die Stadt.



Continental Drive System



COBI Smart Phone Integration



- GREY/ORANGE
- 🚲 Square Urban X
- 🏠 GHOST Alloy Rigid
- 🔧 IXOW Stempark 31.8 mm
- 📏 GHOST Low Rizer 680 mm 31.8 mm
- 🦋 Conti Drive System
- 👤 -
- 🚲 Shimano Alfine SL
- 🦋 Miranda
- 👁️ Conti Drive
- 🚲 Shimano XT Disc 180/160 mm SMRT 64
- 🔧 Michelin StarGrip 37-622
- 📏 Mach1 820 622 x 19
- 🚲 Shimano Hub Dynamo Alfine
- 🚲 Shimano Alfine Internal Gear Hub 11-Speed
- 🔧 GHOST SP 719 31.6 mm
- 🔧 GHOST 2059 HRN
- 🦋 GHOST
- 🦋 GHOST/Wingee
- 🔧 Hebie
- 🔊 COBI Plus automatic front light
- 🔊 COBI Plus automatic rear light
- 🔧 Extra: COBI Plus smart bike system IXOW Nuts, Wheelguard, Safering
- 📏 S/M/L/XL



SQUARE URBAN X 10

28"

- GREY/GREY
- 🚲 Square Urban X
- 🏠 GHOST Alloy Rigid
- 🔧 IXOW Stempark 31.8 mm
- 📏 GHOST Low Rizer 680 mm 31.8 mm
- 🦋 Conti Drive System
- 👤 -
- 🚲 Shimano Alfine SL
- 🦋 Miranda
- 👁️ Conti Drive
- 🚲 Shimano Deore Disc 160 mm SMRT 64
- 🔧 Michelin StarGrip 37-622
- 📏 Mach1 820 622 x 19
- 🚲 Shimano Hub Dynamo Alfine
- 🚲 Shimano Alfine Internal Gear Hub 11-Speed
- 🔧 GHOST SP 719 31.6 mm
- 🔧 GHOST 2059 HRN
- 🦋 GHOST
- 🦋 GHOST/Wingee
- 🔧 Hebie
- 🔊 Supernova E3 Pure 3
- 🔊 Supernova E3 Tail Light 2
- 🔧 Extra: IXOW Nuts, Wheelguard, Safering
- 📏 S/M/L/XL



SQUARE URBAN X 9

28"

SQUARE URBAN X 8

28"



- GREY/SILVER
- 🔪 Square Urban X
- 🏠 GHOST Alloy Rigid
- 🔪 GHOST AS 029 31.8 mm
- 📏 GHOST Low Rizer 680 mm 31.8 mm
- Shimano XT 10-Speed
- 🦶 Shimano Deore
- Shimano Deore SL
- Shimano FC T551 48-36-26
- Shimano 11-34
- ▲ Shimano 396 Disc 160 mm
- 🌀 Michelin StarGrip 37-622
- 🌙 Mach1 / 820 622 x 19
- ⚙️ Shimano Hub Dynamo Alfine
- ⚙️ Shimano FH-RM 33 QR
- 🔪 GHOST SP 719 31.6 mm
- 📏 GHOST 2059 HRN
- 🏠 GHOST
- 🌙 GHOST /Wingee
- 🔪 Hebie
- 🔦 Supernova E3 Pure 3
- 🔦 Supernova E3 Tail Light 2
- S / M / L / XL

SQUARE URBAN X 8 MISS

28"



- GREY/SILVER
- 🔪 Square Urban X Miss
- 🏠 GHOST Alloy Rigid
- 🔪 GHOST AS 029 31.8 mm
- 📏 GHOST Low Rizer 680 mm 31.8 mm
- Shimano XT 10-Speed
- 🦶 Shimano Deore
- Shimano Deore SL
- Shimano FC T551 48-36-26
- Shimano 11-34
- ▲ Shimano 396 Disc 160 mm
- 🌀 Michelin StarGrip 37-622
- 🌙 Mach1 820 622 x 19
- ⚙️ Shimano Hub Dynamo Alfine
- ⚙️ Shimano FH-RM 33 QR
- 🔪 GHOST SP 719 31.6 mm
- 📏 GHOST 2059 DRN
- 🏠 GHOST
- 🌙 GHOST /Wingee
- 🔪 Hebie
- 🔦 Supernova E3 Pure 3
- 🔦 Supernova E3 Tail Light 2
- S / M / L / XL

NIVOLET RACE

ENG

The Colle del Nivolet is known among cyclists as one of the Alps' true challenges. At an elevation of 2600 meters, it ranks as one of the ten highest paved Alpine passes. Designed to tackle this demanding terrain, the Nivolet Race offers excellent power transmission without compromising riding comfort, lateral stiffness or stability. The balanced geometry ensures quick acceleration on the climb, agile handling on the descent, and thanks to our ULC carbon, the frame weighs a mere 880 grams. This is how you conquer the Colle del Nivolet.

GER

Der Colle del Nivolet ist unter Rennradfahrern als eines der wahren Abenteuer in den Alpen bekannt. Mit über 2.600 Meter gehört er zu den zehn höchsten asphaltierten Alpenpässen. Für Herausforderungen wie diese ist das Nivolet Race mit seiner entspannten und dennoch sportlichen Sitzposition das perfekte Rad. Es erlaubt eine rasante Beschleunigung bergauf und begeistert durch ein agiles und stabiles Handling bergab. Unser Topmodell Nivolet Race ULC 4 vereint verlustfreie Kraftübertragung mit viel Fahrkomfort und überzeugt durch seine hohe Seitensteifigkeit, Stabilität und dem extrem niedrigen Rahmengewicht von nur 880 Gramm. Es ist der perfekte Begleiter, um selbst höchste Pässe in Angriff zu nehmen.



ULC NIVOLET RACE 4

28"



- WHITE / RED
- ▾ Nivolet ULC
- ▾ Composite Gear Race Carbon Fork
- ▾ FSA ST-OS-99
- ▾ FSA K-Force Light
- ▾ SRAM Red 11-Speed
- ▾ SRAM Red
- ▾ SRAM Red
- ▾ SRAM Red 50-34
- ▾ SRAM Red 11-28
- ▾ Sram Red
- ▾ Schwalbe One 23-622
- ▾ Fulcrum Wheelset Racing Zero Dark Nite
- ▾ Fulcrum
- ▾ Fulcrum
- ▾ FSA K-Force Light
- ▾ Selle Italia SLR
- ▾ XXS/XS/S/M/L/XL/XXL

NIVOLET TOUR

ENG

Whether you're putting in some quick workout miles after work or you're a serious weekend warrior, Nivolet Tour is the answer to your road bike needs. Boasting similar styling and pedigree as the Nivolet Race, the Tour line delivers great road going performance at an unbeatable price. In both carbon fiber and super svelte aluminum alloy versions, they deliver unsurpassed value, and because they now come in sizes XXS-XXL, these really are bikes that anyone can enjoy.

GER

Das Nivolet Tour ist ein Rennrad, das sich gleichermaßen für entspannte Feierabend-Ausfahrten wie für fordernde Alpentouren eignet. Erhältlich ist es sowohl in einer Carbon- als auch in einer extrem leichten Aluminium-Version. Das Design lehnt sich am Nivolet Race an und überzeugt mit top Performance zu einem starken Preis. Und weil es in Größen von XXS bis XXL erhältlich ist, findet jeder den für ihn perfekt passenden Rahmen.

ULC NIVOLET RACE 2

28"



- WHITE / GREY
- ▾ Nivolet ULC
- ▾ Composite Gear Race Carbon Fork
- ▾ FSA ST-OS-99
- ▾ FSA K-Force
- ▾ SRAM Force 11-Speed
- ▾ SRAM Force
- ▾ SRAM Force
- ▾ SRAM Force 50-34
- ▾ SRAM Force 11-28
- ▾ Sram Force
- ▾ Schwalbe Durano 23-622
- ▾ Fulcrum Racing 3
- ▾ Fulcrum
- ▾ Fulcrum
- ▾ FSA K-Force Light
- ▾ Selle Italia SLR
- ▾ XXS/XS/S/M/L/XL/XXL

- WHITE / RED
- ▾ Nivolet LC
- ▾ Composite Gear Race Carbon Fork
- ▾ FSA ST-OS-99
- ▾ FSA HB-RD-200
- ▾ Shimano Dura Ace 11-Speed
- ▾ Shimano Dura Ace
- ▾ Shimano Dura Ace
- ▾ Shimano Dura Ace 50-34
- ▾ Shimano CS9000 11-28
- ▾ Shimano Dura Ace
- ▾ Schwalbe Durano 25-622
- ▾ Fulcrum Wheelset Racing Zero Dark Nite
- ▾ Fulcrum
- ▾ Fulcrum
- ▾ FSA Energy 27.2 mm
- ▾ GHOST VL 1411
- ▾ XXS/XS/S/M/L/XL/XXL

LC NIVOLET TOUR 6

28"



LC NIVOLET TOUR 5

28"



●	BLACK/RED
↗	Nivolet LC
h	Composite Gear Race Carbon Fork
▲	FSA ST-05-97
▲	FSA HB-RD-315S
⚙	Shimano Ultegra 11-Speed Di2
⚙	Shimano Ultegra Di2
⚙	Shimano Ultegra Di2
⚙	Shimano Ultegra 50-34
▲	Shimano CS6800 11-28
▲	Shimano Ultegra
⚙	Mavic Yksion Pro PowerLink / Yksion Pro Griplink
▲	Mavic Ksyrium Elite red
▲	Mavic
▲	Mavic
⚙	FSA SLK 27.2 mm
▲	GHOST VL 1411
—	XXS/XS/S/M/L/XL/XXL

●	GREY/SILVER
↗	Nivolet LC
h	Composite Gear Race Carbon Fork
▲	FSA ST-05-97
—	FSA HB-RD-315S
⚙	Shimano Ultegra 11-Speed
▲	Shimano 105
⚙	Shimano Ultegra
▲	FSA Gossamer Pro ABS 386Evo 50-34
▲	Shimano CS5800 11-28
▲	FSA Gossamer
▲	Schwalbe Durano 25-622
▲	Fulcrum Racing 5 Wheelset
▲	Fulcrum
▲	Fulcrum
▲	FSA SP SL 282 27.2 mm
▲	GHOST VL 1411
—	XXS/XS/S/M/L/XL/XXL

LC NIVOLET TOUR 3

28"



LC NIVOLET TOUR 4

28"



●	BLACK/BLUE
↗	Nivolet LC
h	Composite Gear Race Carbon Fork
▲	FSA ST-05-97
—	FSA HB-RD-315S
●	Shimano Ultegra 11-Speed
●	Shimano Ultegra
●	Shimano Ultegra
⚙	Shimano Ultegra 50-34
▲	Shimano CS6800 11-28
▲	Shimano Ultegra
⚙	Mavic Yksion Pro PowerLink / Yksion Pro Griplink
▲	Mavic Ksyrium Elite blue
▲	Mavic
▲	Mavic
▲	FSA SP SL 282 27.2 mm
▲	GHOST VL 1411
—	XXS/XS/S/M/L/XL/XXL

●	GREY/SILVER
↗	Nivolet LC
h	Composite Gear Race Carbon Fork
▲	FSA ST-05-97
—	FSA HB-RD-315S
▲	Shimano 105 11-Speed
▲	Shimano 105
▲	Shimano 105
⚙	FSA Gossamer Pro ABS 386Evo 50-34
▲	Shimano CS5800 11-28
▲	FSA Gossamer
▲	Schwalbe Durano 25-622
▲	Fulcrum Racing 5 Wheelset
▲	Fulcrum
▲	Fulcrum
▲	FSA SP SL 282 27.2 mm
▲	GHOST VL 1411
—	XXS/XS/S/M/L/XL/XXL

LC NIVOLET TOUR 2

28"



ROAD

NIVOLET TOUR 3

28"



●	BLACK/RED	
↗	Nivolet Alloy	
h	Composite Gear Race Carbon Fork	
⚙	FSA ST-OS-97	▼
—	FSA HB-RD-315S	
⚙	Shimano Ultegra 11-Speed	▼
⚙	Shimano Ultegra	▼
⚙	Shimano Ultegra	▼
⚙	FSA Gossamer Pro ABS 386 Evo 50-34	▼
⊙	Shimano CS5800 11-28	▼
⊙	FSA Gossamer	▼
⊙	Schwalbe Durano 25-622	
☾	Fulcrum Racing 5 Wheelset	▼
+	Fulcrum	▼
+	Fulcrum	▼
⚙	FSA SP SL 282 27.2 mm	▼
▲	GHOST VL 1411	
—	XS/S/M/L/XL	

NIVOLET TOUR 2

28"



●	GREY/SILVER	
↗	Nivolet Alloy	
h	Composite Gear Race Carbon Fork	
▲	FSA ST-OS-97	
—	FSA HB-RD-315S	
▲	Shimano Tiagra 10-Speed	
▲	Shimano Tiagra	
▲	Shimano Tiagra	
▲	Shimano Tiagra 50-39-30	
▲	Shimano CS-HG50 12-28	
▲	Shimano Tiagra	
▲	Schwalbe Lugano 25-622	
▲	Shimano 501 Wheelset	
▲	Shimano	
▲	Shimano	
▲	FSA SP SL 282 27.2 mm	
▲	GHOST VL 1411	
—	XS/S/M/L/XL	

NIVOLET TOUR DISC

ENG

The best of mountain bike technology has finally made its way onto road bikes. Disc brakes are here and there is no turning back. Independent research has proven the vastly improved performance, setting aside all remaining doubts. Aerodynamics are comparable to conventional rim brakes, but most importantly, disc brakes simply provide better braking power, modulation and safety. Go fast, brake later into corners and enjoy riding the road like you never have before. With superior styling in a performance package, the Nivolet Disc is the modern road bike.

GER

Eine der wichtigsten Mountainbike-Technologien hat endlich ihren Weg auf die Straße gefunden: Scheibenbremsen sind im Rennrad-Segment angekommen. Und es gibt keinen Weg zurück. Unabhängige Untersuchungen haben die bessere Leistung dieser Technik eindrucksvoll bestätigt. Die Aerodynamik ist vergleichbar mit konventionellen Felgenbremsen, und das bei deutlich überlegener Bremskraft, Dosierbarkeit und Zuverlässigkeit. Schneller fahren, später bremsen, mehr Kontrolle – mit seinem erstklassigen Design und der top Ausstattung ist das Nivolet Disc das Rennrad von heute.



LC NIVOLET TOUR DISC 3

28"



●	BLACK/RED
↘	Nivolet LC Disc
h	Composite Gear Race Carbon Fork
⚙	FSA ST-05-97
—	FSA HB-RD-315S
⚙	Shimano Ultegra 11-Speed
⚙	Shimano Ultegra
⚙	Shimano ST-RS685
⚙	Shimano Ultegra 50-34
⊙	Shimano CS6800 11-28
⊙	Shimano BR-RS805 140/160 mm
⊙	Mavic Yksion Elite
☾	Mavic Ksyrium Disc
+	Mavic
+	Mavic
⚙	FSA Energy 27.2 mm
▲	GHOST VL 1411
—	XS/S/M/L/XL

POWERKID

ENG

Learning to ride a bike is a huge milestone for kids. It's a way for them to test limits, create new adventures and explore the world around them. A safe, reliable bicycle is the centerpiece for their fun, and we've hopefully made their riding even more enjoyable by optimizing our frames to build the lightest Powerkid bikes ever.

GER

Fahrradfahren zu lernen ist ein Meilenstein im Leben eines Kindes. Es ist für sie eine Art, Grenzen auszutesten, Abenteuer zu erleben und die Welt zu erkunden. Ein sicheres und zuverlässiges Fahrrad ist der Schlüssel dazu. Und wir haben unseren Teil dazu beigetragen, indem wir den Rahmen noch weiter optimiert und damit das leichteste Powerkid aller Zeiten hergestellt haben.

LC NIVOLET TOUR DISC 2

28"



●	GREY/SILVER
↘	Nivolet LC Disc
h	Composite Gear Race Carbon Fork
⚙	FSA ST-05-97
—	FSA HB-RD-315S
▲	Shimano 105 11-Speed
▲	Shimano 105
▲	ST-RS505
▲	Shimano 105 50-34
▲	Shimano CS5800 11-28
▲	Shimano BR-RS505 140/160 mm
▲	Schwalbe Durano 25-622
▲	Fulcrum Wheelset Racing 5 Disc
▲	Fulcrum
▲	Fulcrum
⚙	FSA SP SL 282 27.2 mm
▲	GHOST VL 1411
—	XS/S/M/L/XL



POWERKID 24 DISC

24"



- BLACK/RED/GREY
- 🔧 Powerkid 24 Alloy
- 🏠 RST Capa 50 mm
- 🔧 GHOST AS GH2 31.8 mm
- 📏 GHOST Low Rizer 580 mm 31.8 mm
- 🔧 Shimano TX 8000 8-Speed
- 🔧 Shimano FD-TX50
- ⚙️ Shimano SL-M310
- 🔧 Lasco Alu Triple 42-34-24
- 🔧 Shimano CS-HG200 12-32
- 🔧 Tektro ACC 001 Disc 160 mm
- 🔧 Schwalbe Black Jack 1.9
- 🌙 Alex TD 26 Disc
- 🔧 GHOST Disc QR
- 🔧 GHOST Disc QR
- 🔧 GHOST Light DC1 31.6 mm
- 🔧 GHOST VL 5062
- one size

POWERKID 24

24"



- BLACK/RED/GREY
- 🔧 Powerkid 24 Alloy
- 🏠 RST Capa 50 mm
- 🔧 GHOST AS GH2 31.8 mm
- 📏 GHOST Low Rizer 580 mm 31.8 mm
- 🔧 Shimano TX 8000 8-Speed
- 🔧 Shimano FD-TX50
- ⚙️ Shimano SL-M310
- 🔧 Lasco Alu Triple 42-34-24
- 🔧 Shimano CS-HG200 12-32
- 🔧 Tektro V-Brake
- 🔧 Schwalbe Black Jack 1.9
- 🌙 Alex DC 26
- 🔧 GHOST QR
- 🔧 GHOST QR
- 🔧 GHOST Light DC1 31.6 mm
- 🔧 GHOST VL 5062
- one size

POWERKID 24 DISC

24"



- WHITE/PINK/PALEPINK
- 🔧 Powerkid 24 Alloy
- 🏠 RST Capa 50 mm
- 🔧 GHOST AS GH2 31.8 mm
- 📏 GHOST Low Rizer 580 mm 31.8 mm
- 🔧 Shimano TX 8000 8-Speed
- 🔧 Shimano FD-TX50
- ⚙️ Shimano SL-M310
- 🔧 Lasco Alu Triple 42-34-24
- 🔧 Shimano CS-HG200 12-32
- 🔧 Tektro ACC 001 Disc 160 mm
- 🔧 Schwalbe Black Jack 1.9
- 🌙 Alex TD 26 Disc
- 🔧 GHOST Disc QR
- 🔧 GHOST Disc QR
- 🔧 GHOST Light DC1 31.6 mm
- 🔧 GHOST VL 5062
- one size

POWERKID 24

24"



- WHITE/PINK/PALEPINK
- 🔧 Powerkid 24 Alloy
- 🏠 RST Capa 50 mm
- 🔧 GHOST AS GH2 31.8 mm
- 📏 GHOST Low Rizer 580 mm 31.8 mm
- 🔧 Shimano TX 8000 8-Speed
- 🔧 Shimano FD-TX50
- ⚙️ Shimano SL-M310
- 🔧 Lasco Alu Triple 42-34-24
- 🔧 Shimano CS-HG200 12-32
- 🔧 Tektro V-Brake
- 🔧 Schwalbe Black Jack 1.9
- 🌙 Alex DC 26
- 🔧 GHOST QR
- 🔧 GHOST QR
- 🔧 GHOST Light DC1 31.6 mm
- 🔧 GHOST VL 5062
- one size

POWERKID 24

24"



- BLACK / GREEN / BLUE
- ▾ Powerkid 24 Alloy
- ┆ RST Capa 50 mm
- ▮ GHOST AS GH2 31.8 mm
- ┄ GHOST Low Rizer 580 mm 31.8 mm
- ♣ Shimano TX 8000 8-Speed
- ♣ Shimano FD-TX50
- ⊕ Shimano SL-M310
- ♣ Lasco Alu Triple 42-34-24
- ⊙ Shimano CS-HG200 12-32
- ▲ Tektro V-Brake
- ⊙ Schwalbe Black Jack 1.9
- ☾ Alex DC 26
- ⊕ GHOST QR
- ⊕ GHOST QR
- ⌘ GHOST Light DC1 31.6 mm
- ▲ GHOST VL 5062
- ┆ one size

- GREEN / CYAN / BLACK
- ▾ Powerkid 20 Alloy
- ┆ RST Capa T 50 mm
- ▮ GHOST AS-601 25.4 mm
- ┄ GHOST Rizer Light 520 mm 25.4 mm
- ♣ Shimano Tourney 7-Speed
- ⊕ Shimano Tourney Revo
- ♣ Lasco Alu Single 36
- ⊙ Shimano Tourney 14-28
- ⊙ Tektro V-Brake
- ⊙ Schwalbe Black Jack 1.9
- ☾ GHOST 20 Wheelset
- ⊕ GHOST 20 Wheelset
- ⊕ GHOST 20 Wheelset
- ⌘ GHOST Light DC1 27.2 mm
- ▲ GHOST VL 5062
- ┆ one size

POWERKID 20

20"



POWERKID 24

24"



- BLACK / PINK / BLUE
- ▾ Powerkid 24 Alloy
- ┆ RST Capa 50 mm
- ▮ GHOST AS GH2 31.8 mm
- ┄ GHOST Low Rizer 580 mm 31.8 mm
- ♣ Shimano TX 8000 8-Speed
- ♣ Shimano FD-TX50
- ⊕ Shimano SL-M310
- ♣ Lasco Alu Triple 42-34-24
- ⊙ Shimano CS-HG200 12-32
- ▲ Tektro V-Brake
- ⊙ Schwalbe Black Jack 1.9
- ☾ Alex DC 26
- ⊕ GHOST QR
- ⊕ GHOST QR
- ⌘ GHOST Light DC1 31.6 mm
- ▲ GHOST VL 5062
- ┆ one size

- CYAN / PINK / BLACK
- ▾ Powerkid 20 Alloy
- ┆ RST Capa T 50 mm
- ▮ GHOST AS-601 25.4 mm
- ┄ GHOST Rizer Light 520 mm 25.4 mm
- ♣ Shimano Tourney 7-Speed
- ⊕ Shimano Tourney Revo
- ♣ Lasco Alu Single 36
- ⊙ Shimano Tourney 14-28
- ⊙ Tektro V-Brake
- ⊙ Schwalbe Black Jack 1.9
- ☾ GHOST 20 Wheelset
- ⊕ GHOST 20 Wheelset
- ⊕ GHOST 20 Wheelset
- ⌘ GHOST Light DC1 27.2 mm
- ▲ GHOST VL 5062
- ┆ one size

POWERKID 20

20"



POWERKID 20

20"



● BLACK/RED
🔧 Powerkid 20 Alloy
🏠 RST Capa T 50 mm
🔧 GHOST AS-601 25.4 mm
📏 GHOST Rizer Light 520 mm 25.4 mm
🦋 Shimano Tourney 7-Speed
⚙️ Shimano Tourney Revo
🔧 Lasco Alu Single 36
🎯 Shimano Tourney 14-28
🌀 Tektro V-Brake
⚙️ Schwalbe Black Jack 1.9
🌙 GHOST 20 Wheelset
⚙️ GHOST 20 Wheelset
⚙️ GHOST 20 Wheelset
🔧 GHOST Light DC1 27.2 mm
🔧 GHOST VL 5062
— one size

● BLACK/RED
🔧 Powerkid 20 Alloy
🏠 GHOST Rigid
🔧 GHOST AS-601 25.4 mm
📏 GHOST Rizer Light 520 mm 25.4 mm
🦋 Shimano Tourney 7-Speed
⚙️ Shimano Tourney Revo
🔧 Lasco Alu Single 36
🎯 Shimano Tourney 14-28
🌀 Tektro V-Brake
⚙️ Schwalbe Black Jack 1.9
🌙 GHOST 20 Wheelset
⚙️ GHOST 20 Wheelset
⚙️ GHOST 20 Wheelset
🔧 GHOST Light DC1 27.2 mm
🔧 GHOST VL 5062
— one size

POWERKID 20 RIGID

20"



POWERKID 20

20"



● WHITE/PINK/PALEPINK
🔧 Powerkid 20 Alloy
🏠 RST Capa T 50 mm
🔧 GHOST AS-601 25.4 mm
📏 GHOST Rizer Light 520 mm 25.4 mm
🦋 Shimano Tourney 7-Speed
⚙️ Shimano Tourney Revo
🔧 Lasco Alu Single 36
🎯 Shimano Tourney 14-28
🌀 Tektro V-Brake
⚙️ Schwalbe Black Jack 1.9
🌙 GHOST 20 Wheelset
⚙️ GHOST 20 Wheelset
⚙️ GHOST 20 Wheelset
🔧 GHOST Light DC1 27.2 mm
🔧 GHOST VL 5062
— one size

● WHITE/PINK/PALEPINK
🔧 Powerkid 20 Alloy
🏠 GHOST Rigid
🔧 GHOST AS-601 25.4 mm
📏 GHOST Rizer Light 520 mm 25.4 mm
🦋 Shimano Tourney 7-Speed
⚙️ Shimano Tourney Revo
🔧 Lasco Alu Single 36
🎯 Shimano Tourney 14-28
🌀 Tektro V-Brake
⚙️ Schwalbe Black Jack 1.9
🌙 GHOST 20 Wheelset
⚙️ GHOST 20 Wheelset
⚙️ GHOST 20 Wheelset
🔧 GHOST Light DC1 27.2 mm
🔧 GHOST VL 5062
— one size

POWERKID 20 RIGID

20"



POWERKID 16

16"

●	BLACK/BLUE/GREEN
↘	Powerkid 16 Alloy
h	Rigid
⊖	JC
—	JC
⚙	JM
⊙	Single Speed
⊗	Front: V-Brake/ Rear: Backpedal Brake
⊗	Kenda 16
∪	AL 16
+	Joytech/KT
+	Joytech/KT
⚡	Leadtec
▲	Velo
—	one size



●	WHITE/BLUE/PINK
↘	Powerkid 16 Alloy
h	Rigid
⊖	JC
—	JC
⚙	JM
⊙	Single Speed
⊗	Front: V-Brake/ Rear: Backpedal Brake
⊗	Kenda 16
∪	AL 16
+	Joytech/KT
+	Joytech/KT
⚡	Leadtec
▲	Velo
—	one size



POWERKID 16

16"

●	GREEN/YELLOW/BLACK
↘	Powerkid 16 Alloy
h	Rigid
⊖	JC
—	JC
⚙	JM
⊙	Single Speed
⊗	Front: V-Brake/ Rear: Backpedal Brake
⊗	Kenda 16
∪	AL 16
+	Joytech/KT
+	Joytech/KT
⚡	Leadtec
▲	Velo
—	one size

POWERKID 16

16"



●	PINK/WHITE/PURPLE
↘	Powerkid 16 Alloy
h	Rigid
⊖	JC
—	JC
⚙	JM
⊙	Single Speed
⊗	Front: V-Brake/ Rear: Backpedal Brake
⊗	Kenda 16
∪	AL 16
+	Joytech/KT
+	Joytech/KT
⚡	Leadtec
▲	Velo
—	one size



POWERKID 16

16"

POWERKID 12

12"

● BLACK / GREEN / WHITE
Powerkid 12 Alloy
Rigid
JC
JC
JM
Single Speed
Front: V-Brake/Rear: Backpedal Brake
Kenda 12
AL 12
Joytech / KT
Joytech / KT
Leadtec
Velo
one size

● ORANGE / RED / BLACK
Powerkid 12 Alloy
Rigid
JC
JC
JM
Single Speed
Front: V-Brake/Rear: Backpedal Brake
Kenda 12
AL 12
Joytech / KT
Joytech / KT
Leadtec
Velo
one size



POWERKID 12

12"

POWERKID 12

12"

● GREEN / YELLOW / RED
Powerkid 12 Alloy
Rigid
JC
JC
JM
Single Speed
Front: V-Brake/Rear: Backpedal Brake
Kenda 12
AL 12
Joytech / KT
Joytech / KT
Leadtec
Velo
one size

● PINK / WHITE / PURPLE
Powerkid 12 Alloy
Rigid
JC
JC
JM
Single Speed
Front: V-Brake/Rear: Backpedal Brake
Kenda 12
AL 12
Joytech / KT
Joytech / KT
Leadtec
Velo
one size



POWERKID 12

12"

POWERKIDDY 12

12"



● GREEN
↗ Powerkiddy 12 Alloy
⌈ Rigid
⦿ JC
— JC
⊙ Kenda 12
⌒ AL 12
⚙ Joytech / KT
⚙ Joytech / KT
⚙ Leadtec
⚙ Velo
— one size

POWERKIDDY 12

12"



● PURPLE
↗ Powerkiddy 12 Alloy
⌈ Rigid
⦿ JC
— JC
⊙ Kenda 12
⌒ AL 12
⚙ Joytech / KT
⚙ Joytech / KT
⚙ Leadtec
⚙ Velo
— one size

EBS

ENG

Competition, effort, adrenalin, sweat, victory. Our HTX models have already won nearly every race and title. Olympic Gold, Overall World Cup titles, World Championships, World Cup victories, and a new title is added almost every weekend. When the world's top riders battle it out, details matter – the perfect geometry, balanced handling, the right components, down to the last gram. Thanks to the input of our professional riders and our experience, MountainBIKE magazine in 2014 crowned our HTX as THE best hardtail ever. And now at a nicer price, the best just got even better.

GER

Anstrengung und Adrenalin, Schweiß und Siege – unsere HTX-Modelle haben so ziemlich jedes Rennen und jeden Titel gewonnen, darunter olympisches Gold, Gesamtsiege im Worldcup und Weltmeistertitel. Wenn die besten Fahrer der Welt um Sekundenbruchteile kämpfen, kommt es auf jedes Detail an – auf jedes Gramm und jeden Millimeter in der Geometrie. Dank des Inputs unserer Profifahrer kürte das MountainBIKE Magazin 2014 unser HTX zum besten Hardtail aller Zeiten. Und mit der HTX Eurobike Special Edition gibt es dieses legendäre Bike nun mit einem unschlagbaren Preis-Leistungs-Verhältnis.



HTX EBS 2

29"



- RED/BLACK/DARKRED/WHITE
- HTX 29 Carbon
- ⌄ Fox 32 Float Performance 100 mm
- GHOST M01 31.8 mm
- GHOST Low Rizer 720 mm 31.8 mm
- Shimano XT 11-Speed Plus
- Shimano XT
- Shimano XT SL
- Shimano XT 36-26
- Shimano XT 11-40
- Shimano SLX Disc 180/160 mm
- Michelin Wild Race'R 2.25
- Rigida Rival 21
- Shimano Deore DR
- Shimano Deore DR
- GHOST Light DC1 27.2 mm
- GHOST VL 1353
- XS/S/M/L/XL

HTX EBS 1

29"



- BLACK/RED/WHITE/DARKRED
- HTX 29 Carbon
- ▲ ⌄ Rock Shox 30 Gold Air RL 100 mm
- GHOST M01 31.8 mm
- GHOST Low Rizer 720 mm 31.8 mm
- ▲ Shimano XT 10-Speed
- ▲ Shimano Deore
- ▲ Shimano Deore SL
- ▲ Shimano Deore 40-30-22
- ▲ Shimano CS-HG50 11-36
- ▲ Shimano 396 Disc 180/160 mm
- Michelin Wild Race'R 2.25
- Rigida Rival 21
- ▲ Shimano 4050 QR
- ▲ Shimano 4050 QR
- GHOST Light DC1 27.2 mm
- GHOST VL 1353
- XS/S/M/L/XL



ALL BIKES IN ONE PLACE

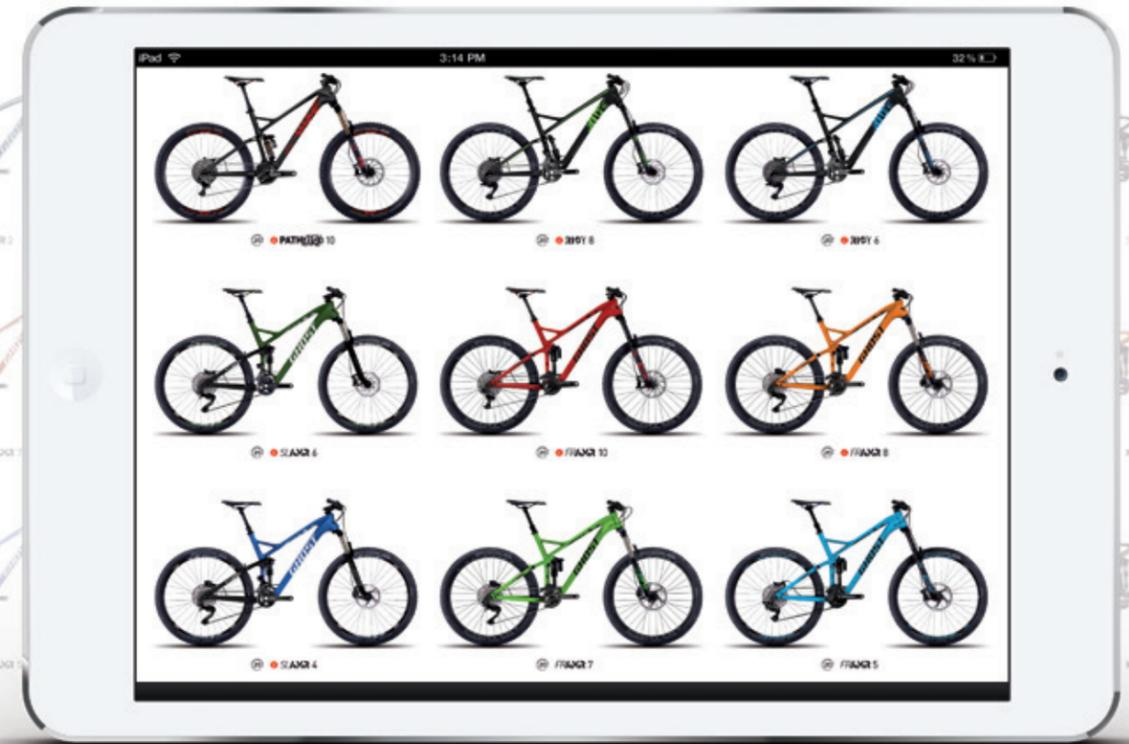

Our workbook now also available as an iPad app



GET **APP** AND GO!

POWERTRAXX

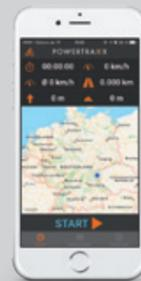

Live your activities – train smart

Try our unique GPS enabled tracking app loaded with revolutionary new functions to help you train more effectively and achieve your personal goals.

GET APP AND GO!
www.ghost-bikes.com/powertraxx

GHOST

Kitzbüheler Alpen



100% Radlspaß in den Kitzbüheler Alpen.

Urlaub bei den Bike-Spezialisten!



Tirel

GHOST

www.kitzalps.com/bike

COCKPIT SETUP

ENG

The brake levers should be mounted in a position that allows your index fingers to apply maximum pressure on the levers during braking efforts. It is also important that your forearm and index finger form a relatively straight line in this process and that your wrist is not overly bent. For more tips on how to set up your bike and advice on riding technique, check out our video series with riding technique coach Kurt Exenberger.

GER

Die Bremsen sollten relativ weit innen montiert werden. So bekommst du beim Bremsen mit deinem Zeigefinger die meiste Kraft auf den Bremshebel. Wichtig ist auch, dass dein Unterarm mit deinem Zeigefinger beim Bremsen eine gerade Linie bildet und im Handgelenk kein Knick entsteht. Für mehr Tipps zur richtigen Bikeeinstellung und Fahrtechnik schau dir unsere Videoreihe mit Fahrtechniktrainer Kurt Exenberger an.



TUTORIAL VIDEOS

www.youtube.com/GHOSTBikesGmbH

CORRECT POSITION

ENG

POSITION 1: With the crank at the lowest position, ensure your that knee is slightly bent, but you can still apply maximum pressure to the pedals. Your index finger should be aligned with your forearms when braking. Avoid a bend in your wrist.

GER

POSITION 1: In der niedrigsten Kurbelposition sollte das Knie immer noch leicht gebeugt sein, damit man den vollen Druck auf das Pedal bringt. Der Zeigefinger sollte beim Bremsen eine gerade Linie mit dem Unterarm bilden. Das Handgelenk sollte nicht gebeugt sein.

INCORRECT POSITION

ENG

POSITION 2: The saddle is too high and the brake levers are adjusted too low. Effective pedaling is impossible, because you have to rock back and forth on the saddle, which causes saddle sores. Your hands might also get numb in this situation.

POSITION 3: The saddle is too low and the brake levers are adjusted too high. The result is that you waste a lot of energy while pedaling and your hands might get numb.

GER

POSITION 2: Der Sattel ist zu hoch und die Bremshebel sind zu tief eingestellt. Effizientes Pedalieren ist nicht möglich, und man rutscht auf dem Sattel unweigerlich vor und zurück, was wunde Stellen verursacht. In den Händen kann ein Taubheitsgefühl entstehen.

POSITION 3: Der Sattel ist zu niedrig und die Bremshebel sind zu hoch eingestellt. Dies führt zu einem großen Energieverlust beim Pedalieren und kann zu einem Taubheitsgefühl in den Händen führen.

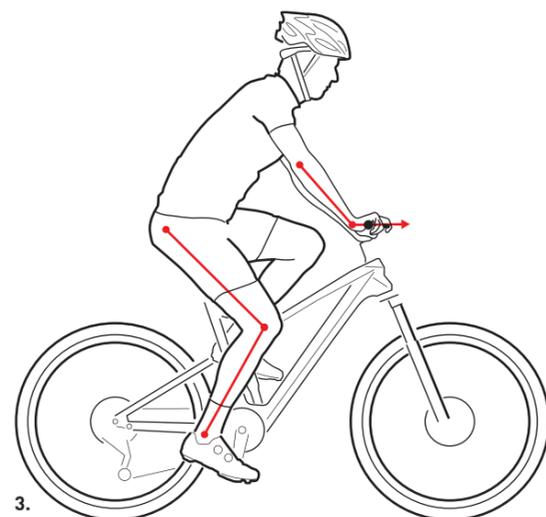
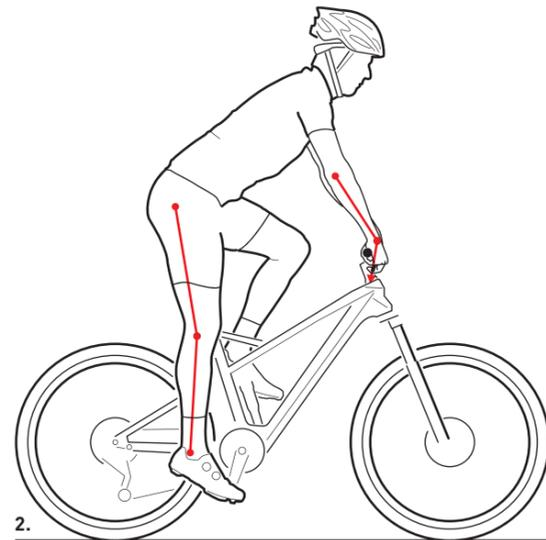
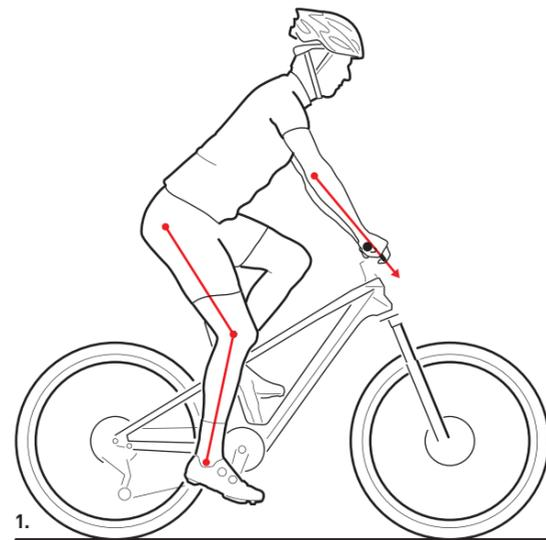

SUSPENSION SET UP

ENG

SET YOUR SUSPENSION

STEP 1: SETTING THE SAG

SAG - also called negative travel - describes the amount of travel which the fork and shock get compressed by due to the rider's weight. SAG is required in order to guarantee road grip even when the terrain becomes uneven and when you hit potholes, for example. In order to correctly set the SAG, you must make sure that both the fork and shock are unblocked. A rubber ring on the fork and shock helps you determine the SAG. In case no rubber ring is assembled on the piston rod of the fork or shock you can alternatively mount a cable tie on it. Get on your bike and assume the standing riding position. Bounce several times, then after reassuming the sitting position, push the ring or cable tie against the seal. After getting off the bike carefully, you can determine the SAG by the position of the ring or cable tie. Set the air pressure with a shock pump so that the fork has 20% of SAG and the shock 25% (30% for the RIOT and PathRIOT).

TIP:

Adjust to a SAG of 25% on the fork and 30% on the shock for a more comfortable ride.

STEP 2: SETTING THE REBOUND

After an impact, the shock and the fork have to move back to their original position in a controlled way and at a perfectly regulated Speed. Rebound controls the Speed at which the fork extends after compressing.

Please refer to the owner's manual to find out exactly how to adjust the rebound Speed on the respective fork or shock.

TIP:

Decrease the rebound Speed for more control on fast downhill.
Increase the rebound Speed for a smooth ride in rough terrain.

GER

FAHRWERKSEINSTELLUNG

SCHRITT 1: DIE SAG-EINSTELLUNG

SAG - auch als Negativfederweg bezeichnet - beschreibt den Weg, den Gabel und Dämpfer unter der Belastung durch das Fahrergewicht eintauchen. Der SAG ist nötig, um auch bei Fahrbahnebenheiten wie z. B. Schlaglöchern den Fahrkontakt zu gewährleisten. Um den SAG richtig einstellen zu können, vergewisserst du dich zuvor, dass Gabel und Dämpfer nicht blockiert sind. Ein Gummiring an Gabel und Dämpfer helfen dir, den SAG zu bestimmen. Falls kein Gummiring auf der Kolbenstange von Gabel oder Dämpfer montiert ist, kann alternativ ein Kabelbinder daran befestigt werden. Dann begibst du dich auf dein Bike und nimmst die stehende Fahrposition ein. Nach mehrmaligem Wippen und Einnehmen der Sitzposition schiebst du den Gummiring oder Kabelbinder gegen die Dichtung. Steige vorsichtig ab und stelle anhand der Position des Gummirings oder Kabelbinders den SAG fest. Mit einer Dämpfer-Pumpe wird der Luftdruck in Gabel und Dämpfer so eingestellt, dass die Gabel 20 % und der Dämpfer 25 % (30 % bei RIOT und PathRIOT) SAG bereitstellen.

TIPP:

Für mehr Fahrkomfort stellst du den Luftdruck auf 25 % SAG an der Gabel und 30 % am Dämpfer ein.

SCHRITT 2: DIE REBOUND-EINSTELLUNG (REBOUND = ZUGSTUFE):

Nachdem ein Fahrstoß verarbeitet wurde, müssen sich Gabel und Dämpfer kontrolliert und mit wohldosierter Geschwindigkeit in die Ausgangsposition zurückbewegen. Diese Ausfedergeschwindigkeit regelt der Rebound. Wie der Rebound an der Gabel oder am Dämpfer genau einzustellen ist, wird in der betreffenden Bedienungsanleitung beschrieben.

TIPP:

Reduziere die Ausfedergeschwindigkeit für mehr Kontrolle auf schnellen Downhills.
Erhöhe die Ausfedergeschwindigkeit für ein ruhiges Fahrwerk in ruppigem Gelände.

GEOMETRY AND DATA CHARTS

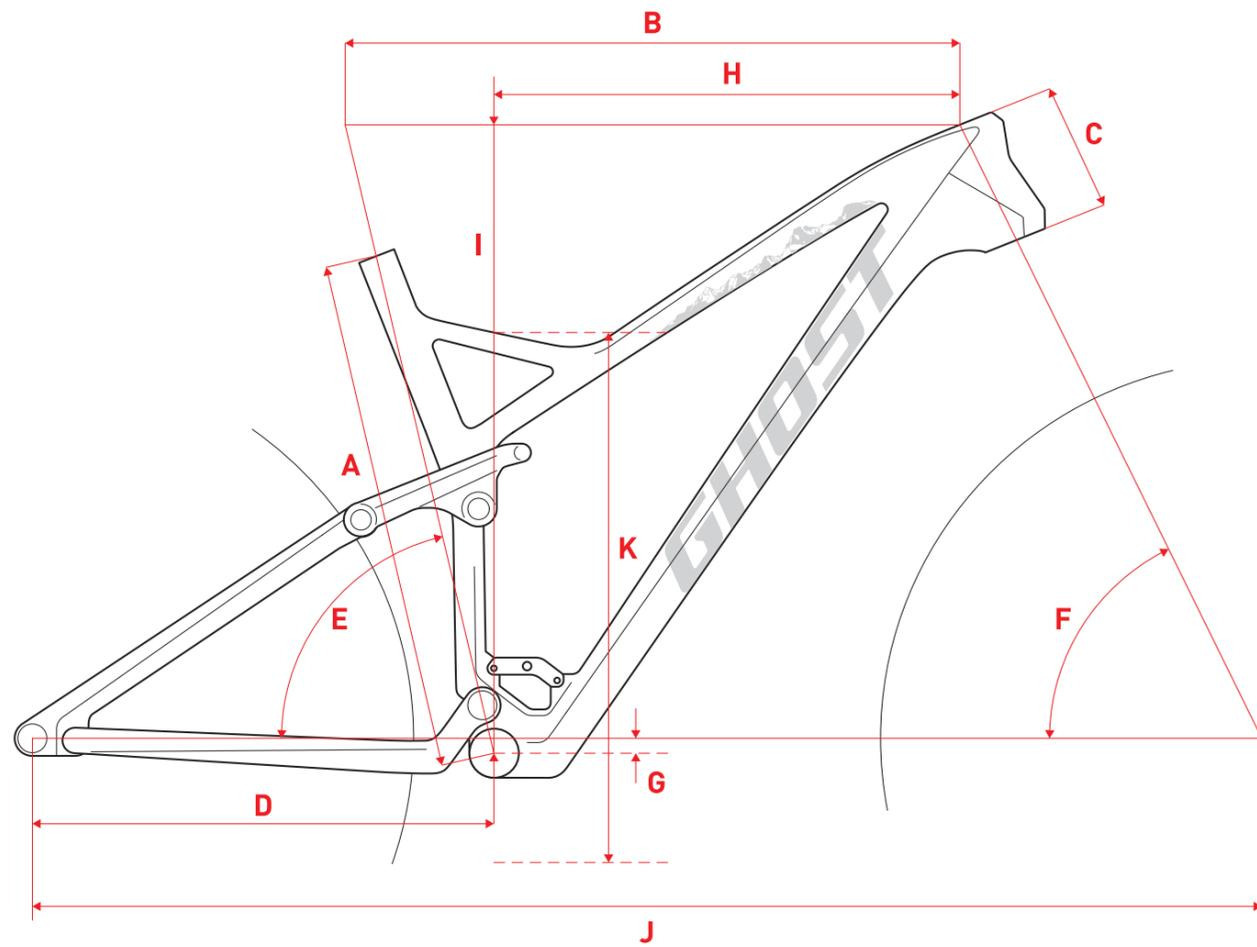

- A** SEAT TUBE LENGTH
SITZROHRLÄNGE
- B** TOP TUBE LENGTH
OBERROHRLÄNGE
- C** HEADTUBE LENGTH
STEUERROHRLÄNGE
- D** CHAINSTAY LENGTH
KETTENSTREBENLÄNGE
- E** SEATTUBE ANGLE
SITZROHRWINKEL
- F** HEADTUBE ANGLE
STEUERROHRWINKEL
- G** BB DROP
TRETLAGERABSENKUNG
- H** REACH
REACH
- I** STACK
STACK
- J** WHEELBASE
RADSTAND
- K** STAND OVER HEIGHT
ÜBERSTANDSHÖHE
- 🏍️** HEAD SET (DIAMETER UPPER/LOWER CUP)
STEUERSATZDURCHMESSER (OBEN/UNTEN)
- 🏍️** STEM LENGTH
VORBAULÄNGE
- 🏍️** HANDLEBAR WIDTH
LENKERBREITE
- 🏍️** CRANK LENGTH
KURBELLÄNGE
- 🏍️** SEAT POST DIAMETER
SÄTTELSTÜTZENDURCHMESSER
- 🏍️** FRONT FORK TRAVEL
FEDERWEG VORNE
- 🏍️** REAR WHEEL TRAVEL
FEDERWEG HINTEN
- 🏍️** SHOCK LENGTH
DÄMPFEREINBAULÄNGE
- 🏍️** SHOCK TRAVEL
DÄMPFERHUB
- 🏍️** SHOCK HARDWARE
DÄMPFERBUCHSENMASSE
- 🏍️** MIN SADDLE HEIGHT
MIN SÄTTELHÖHE
- 🏍️** MAX SADDLE HEIGHT
MAX SÄTTELHÖHE
- 🏍️** MIN INSEAM
MIN SCHRITTLÄNGE
- 🏍️** MAX INSEAM
MAX SCHRITTLÄNGE

All dimensions in mm (except E and F in °)
Alle Maße in mm (Ausnahme E und F in °)

PATHRIOT LC 10, 8														🏍️	🏍️	🏍️	🏍️	🏍️	🏍️	🏍️	🏍️	🏍️	🏍️
	A	B	C	D	E	F	G	H	I	J	K	🏍️	🏍️	🏍️	🏍️	🏍️	🏍️	🏍️	🏍️				
S	440	585	120	425	75,5	66,5	-11	425	619	1162	735	44/56	35	800	170	31,6	170	150	200	58	25,4/16		
M	460	605	130	425	75,5	66,5	-11	443	628	1184	755	44/56	35	800	170	31,6	170	150	200	58	25,4/16		
L	480	625	140	425	75,5	66,5	-11	460	637	1205	775	44/56	50	800	170	31,6	170	150	200	58	25,4/16		

RIOT LC 10, 8, 6														🏍️	🏍️	🏍️	🏍️	🏍️	🏍️	🏍️	🏍️	🏍️	🏍️
	A	B	C	D	E	F	G	H	I	J	K	🏍️	🏍️	🏍️	🏍️	🏍️	🏍️	🏍️	🏍️	🏍️			
XS	400	570	100	430	73	67	-3	395	580	1115	720	42/52,1	50	760	175	31,6	150/130	130	190	51	25,4/16		
S	440	590	110	430	73	67	-3	407	590	1130	735	42/52,1	50	760	175	31,6	150/130	130	190	51	25,4/16		
M	480	615	120	430	73	67	-3	427	600	1155	755	42/52,1	60	760	175	31,6	150/130	130	190	51	25,4/16		
L	520	640	130	430	73	67	-3	450	610	1182	780	42/52,1	60	760	175	31,6	150/130	130	190	51	25,4/16		
XL	560	655	140	430	73	67	-3	462	620	1197	795	42/52,1	60	760	175	31,6	150/130	130	190	51	25,4/16		

SLAMR (LC) 10, 8, 7, 6, 5, 4														🏍️	🏍️	🏍️	🏍️	🏍️	🏍️	🏍️	🏍️	🏍️	🏍️
	A	B	C	D	E	F	G	H	I	J	K	🏍️	🏍️	🏍️	🏍️	🏍️	🏍️	🏍️	🏍️	🏍️			
XS	420	560	100	430	75	68	-15	406	574	1108	720	44/56	60	740	175	31,6	130	130	200	51	33/22		
S	440	575	110	430	75	68	-15	419	583	1125	725	44/56	60	740	175	31,6	130	130	200	51	33/22		
M	480	600	120	430	75	68	-15	441	592	1151	740	44/56	70	740	175	31,6	130	130	200	51	33/22		
L	520	625	130	430	75	68	-15	463	602	1177	775	44/56	70	740	175	31,6	130	130	200	51	33/22		
XL	560	645	140	430	74,5	68	-15	476	611	1193	805	44/56	80	740	175	31,6	130	130	200	51	33/22		

SLAMR X (LC) 10, 8, 7, 5														🏍️	🏍️	🏍️	🏍️	🏍️	🏍️	🏍️	🏍️	🏍️	🏍️
	A	B	C	D	E	F	G	H	I	J	K	🏍️	🏍️	🏍️	🏍️	🏍️	🏍️	🏍️	🏍️	🏍️			
XS	420	560	100	430	74	67	-6	395	582	1118	730	44/56	60	760	175	31,6	150/120	150	200	57	33/22		
S	440	580	110	430	74	67	-6	407	592	1134	735	44/56	60	760	175	31,6	150/120	150	200	57	33/22		
M	480	605	120	430	73,5	67	-6	429	601	1160	750	44/56	60	760	175	31,6	150/120	150	200	57	33/22		
L	520	630	130	430	73,5	67	-6	452	611	1186	785	44/56	60	760	175	31,6	150/120	150	200	57	33/22		
XL	560	645	140	430	73,5	67	-6	464	620	1202	815	44/56	60	760	175	31,6	150/120	150	200	57	33/22		

FRAMR (LC) 10, 8, 7, 5														🏍️	🏍️	🏍️	🏍️	🏍️	🏍️	🏍️	🏍️	🏍️	🏍️
	A	B	C	D	E	F	G	H	I	J	K	🏍️	🏍️	🏍️	🏍️	🏍️	🏍️	🏍️	🏍️	🏍️			
XS	420	565	100	430	73,5	66,5	-2	390	585	1122	735	44/56	55	780/800	175	31,6	160	160	216	63	33/22		
S	440	580	110	430	73,5	66,5	-2	403	594	1138	740	44/56	55	780/800	175	31,6	160	160	216	63	33/22		
M	480	605	120	430	73,5	66,5	-2	425	604	1164	755	44/56	55	780/800	175	31,6	160	160	216	63	33/22		
L	520	630	130	430	73,5	66,5	-2	448	613	1190	790	44/56	55	780/800	175	31,6	160	160	216	63	33/22		
XL	560	650	140	430	73	66,5	-2	460	623	1206	820	44/56	55	780/800	175	31,6	160	160	216	63	33/22		

AMR (LC) 9, 8, 6, 4, 2														🏍️	🏍️	🏍️	🏍️	🏍️	🏍️	🏍️	🏍️	🏍️	🏍️
	A	B	C	D	E	F	G	H	I	J	K	🏍️	🏍️	🏍️	🏍️	🏍️	🏍️	🏍️	🏍️	🏍️			
XS	400	575	110	440	73,5	69	-32	390	612	1102	750	42/52,1	60	740	175	31,6	130	120	200	57	22,2		
S	440	595	110	440	73,5	69	-32	410	612	1122	750	42/52,1	60	740	175	31,6	130	120	200	57	22,2		
M	480	615	120	440	73,5	69	-32	425	622	1142	760	42/52,1	70	740	175	31,6	130	120	200	57	22,2		
L	520	635	120	440	73,5	69	-32	447	622	1165	780	42/52,1	80	740	175	31,6	130	120	200	57	22,2		
XL	560	655	120	440	73,5	69	-32	467	622	1185	805	42/52,1	90	740	175	31,6	130	120	200	57	22,2		

KATO FS 5, 3, 2														🏍️	🏍️	🏍️	🏍️	🏍️	🏍️	🏍️	🏍️	🏍️	🏍️
	A	B	C	D	E	F	G	H	I	J	K	🏍️	🏍️	🏍️	🏍️	🏍️	🏍️	🏍️	🏍️	🏍️			
XS	380	560	100	430	75	69	-15	405	578	1098	680	44/56	60	720	175	31,6	130	130	200	51	33/22		
S	420	575	110	430	75	69	-15	418	587	1114	700	44/56	60	720	175	31,6	130	130	200	51	33/22		
M	460	600	120	430	75	69	-15	440	597	1141	745	44/56	75	720	175	31,6	130	130	200	51	33/22		
L	500	625	130	430	75	69	-15	462	606	1166	755	44/56	75	720	175	31,6	130	130	200	51	33/22		
XL	540	645	140	430	75	69	-15	475	615	1182	785	44/56	90	720	175	31,6	130	130	200	51	33/22		

LECTOR LC/ULC World Cup 10, 9, 8, 7, 6, 5, 3														🏍️	🏍️	🏍️	🏍️	🏍️	🏍️	🏍️	🏍️	🏍️	🏍️
	A	B	C	D	E	F	G	H	I	J	K	🏍️	🏍️	🏍️	🏍️	🏍️	🏍️	🏍️	🏍️	🏍️			
XS	380	580	95	430	71,5	69,5	-60	395	607	1077	695	42/52,1	60	720	175	31,6	100						
S	420	595	95	430	71,5	69,5	-60	410	607	1092	725	42/52,1	70	720	175	31,6	100						
M	460	610	105	430	71,5	69,5	-60	423	616	1108	730	42/52,1	90	720	175	31,6	100						
L	500	625	115	430	71,5	69,5	-60	433	626	1121	770	42/52,1	100	720	175	31,6	100						
XL	540	640	125	430	71,5	69,5	-60	443	635	1135	780	42/52,1	110	720	175	31,6	100						

ASKET LC 9, 8, 5, 3														🏍️	🏍️	🏍️	🏍️	🏍️	🏍️	🏍️	🏍️	🏍️	🏍️
	A	B	C	D	E	F	G	H	I	J	K	🏍️	🏍️	🏍️	🏍️	🏍️	🏍️	🏍️	🏍️	🏍️			
XS	380	555	100	423	73	68	-40	376	587	1065	690	42/52,1	60	760	175	31,6	130						
S	420	575	110	423	73	68	-40	393	596	1086	720	42/52,1	60	760	175	31,6	130						
M	460	595	110	423																			

GEOMETRY AND DATA CHARTS



TACANA 7, 5																	
	A	B	C	D	E	F	G	H	I	J	K						
XS	380	580	100	445	73	70	-65	390	620	1085	690	44/56	60	720	175	31.6	100
S	420	595	110	445	73	70	-65	402	627	1100	695	44/56	70	720	175	31.6	100
M	460	610	120	445	73	70	-65	415	637	1115	730	44/56	80	720	175	31.6	100
L	500	620	130	445	73	70	-65	420	645	1125	765	44/56	90	720	175	31.6	100
XL	540	630	140	445	73	70	-65	430	655	1135	795	44/56	100	720	175	31.6	100

TACANA 4, 3, 2, 1																	
	A	B	C	D	E	F	G	H	I	J	K						
XS	380	570	100	445	73	70	-65	380	620	1075	685	44	60	720	175	31.6	100
S	420	585	110	445	73	70	-65	395	627	1090	695	44	75	720	175	31.6	100
M	460	600	120	445	73	70	-65	405	637	1105	725	44	75	720	175	31.6	100
L	500	610	130	445	73	70	-65	412	645	1115	760	44	90	720	175	31.6	100
XL	540	620	140	445	73	70	-65	420	655	1125	790	44	105	720	175	31.6	100

TACANA X 8, 6																	
	A	B	C	D	E	F	G	H	I	J	K						
XS	380	580	90	430	73	69	-65	395	605	1080	685	44/56	60	720	175	31.6	100
S	420	595	100	430	73	69	-65	407	615	1095	695	44/56	70	720	175	31.6	100
M	460	610	110	430	73	69	-65	420	622	1112	725	44/56	80	720	175	31.6	100
L	500	620	120	430	73	69	-65	425	632	1122	760	44/56	90	720	175	31.6	100
XL	540	630	130	430	73	69	-65	432	642	1132	795	44/56	100	720	175	31.6	100

KATO 4, 3, 2, 1																	
	A	B	C	D	E	F	G	H	I	J	K						
XS	380	570	100	435	73	68	-41	390	590	1095	680	44	60	720	175	31.6	120
S	420	585	110	435	73	68	-41	402	597	1110	695	44	75	720	175	31.6	120
M	460	600	120	435	73	68	-41	415	605	1125	727	44	75	720	175	31.6	120
L	500	620	130	435	73	68	-41	430	615	1145	760	44	90	720	175	31.6	120
XL	540	640	140	435	73	68	-41	447	630	1167	792	44	105	720	175	31.6	120

KATO X 8, 6																	
	A	B	C	D	E	F	G	H	I	J	K						
XS	380	570	100	420	73	68	-41	390	590	1075	680	44/56	60	720	175	31.6	120
S	420	585	110	420	73	68	-41	400	600	1092	700	44/56	70	720	175	31.6	120
M	460	600	110	420	73	68	-41	415	600	1107	745	44/56	80	720	175	31.6	120
L	500	620	120	420	73	68	-41	435	610	1130	765	44/56	90	720	175	31.6	120
XL	540	640	130	420	73	68	-41	450	620	1162	810	44/56	100	720	175	31.6	120

KATO 7, 5																	
	A	B	C	D	E	F	G	H	I	J	K						
XS	380	570	100	435	73	68	-41	390	590	1095	680	44/56	60	720	175	31.6	120
S	420	585	110	435	73	68	-41	402	597	1110	695	44/56	70	720	175	31.6	120
M	460	600	120	435	73	68	-41	415	605	1125	727	44/56	80	720	175	31.6	120
L	500	620	130	435	73	68	-41	430	615	1145	760	44/56	90	720	175	31.6	120
XL	540	640	140	435	73	68	-41	447	630	1167	792	44/56	100	720	175	31.6	120

SONA 2																	
	A	B	C	D	E	F	G	H	I	J	K						
XXS	340	560	115	425	73.5	71	-35	390	575	1040	610	44	60	680	170	31.6	100
XS	380	570	125	425	73.5	71	-35	395	585	1050	650	44	60	680	170	31.6	100
S	420	580	135	425	73.5	71	-35	405	595	1060	685	44	75	680	170	31.6	100
M	460	595	135	425	73	71	-35	415	595	1070	700	44	75	680	170	31.6	100
L	500	605	155	425	73	71	-35	415	615	1080	735	44	90	680	170	31.6	100
XL	540	620	170	425	72.5	71	-35	425	625	1095	775	44	105	680	170	31.6	100

NILA LC 5, 3																	
	A	B	C	D	E	F	G	H	I	J	K						
XS	340	550	100	425	74	69	-56	380	595	1055	647	42/52,1	60	700	175	27.2	100
S	400	570	110	425	74	69	-56	397	600	1072	677	42/52,1	70	700	175	27.2	100
M	440	585	110	425	74	69	-56	412	600	1092	690	42/52,1	80	700	175	27.2	100
L	480	595	110	425	74	69	-56	422	600	1102	712	42/52,1	90	700	175	27.2	100

LANAO FS 7, 4, 2																	
	A	B	C	D	E	F	G	H	I	J	K						
S	380	530	110	430	75	69	-13	371	585	1062	685	44/56	60	700	170	31.6	130
M	420	560	110	430	75	69	-13	401	585	1092	705	44/56	60	700	170	31.6	130
L	460	590	120	430	75	69	-13	429	594	1123	735	44/56	75	700	170	31.6	130

LANAO 7, 5																	
	A	B	C	D	E	F	G	H	I	J	K						
XS	340	545	100	435	73	70	-40	367	580	1045	630	44	60	680	175	31.6	100
S	380	560	110	435	73	70	-40	380	590	1062	637	44	70	680	175	31.6	100
M	420	575	120	435	73	70	-40	392	600	1077	670	44	80	680	175	31.6	100
L	460	585	130	435	73	70	-40	397	607	1087	702	44	90	680	175	31.6	100
XL	500	595	140	435	73	70	-40	405	617	1097	737	44	100	680	175	31.6	100

LANAO 4, 3, 2, 1																	
	A	B	C	D	E	F	G	H	I	J	K						
XS	340	545	110	435	73	70	-40	365	587	1045	632	44	60	680	175	31.6	100
S	380	560	110	435	73	70	-40	380	587	1060	630	44	75	680	175	31.6	100
M	420	575	120	435	73	70	-40	392	600	1075	660	44	75	680	175	31.6	100
L	460	585	130	435	73	70	-40	400	607	1087	692	44	90	680	175	31.6	100
XL	500	595	140	435	73	70	-40	405	617	1097	725	44	105	680	175	31.6	100

LAWU 2																	
	A	B	C	D	E	F	G	H	I	J	K						
XS	340	550	115	425	71	73.5	-35	377	575	1030	615	44	60	660	170	31.6	100
S	380	560	125	425	71	73.5	-35	385	585	1040	645	44	60	660	170	31.6	100
M	420	570	135	425	71	73.5	-35	390	595	1050	660	44	75	660	170	31.6	100
L	460	590	135	425	71	73	-35	405	595	1065	690	44	75	660	170	31.6	100
XL	500	600	145	425	71	73	-35	415	605	1075	725	44	90	660	170	31.6	100

TERU FS 9, 7, 5																	
	A	B	C	D	E	F	G	H	I	J	K						
S	440	590	110	500	73.5	69	-32	407	612	1180	745	44/56	70	720	175	27.2	130
M	480	61															

GEOMETRY AND DATA CHARTS



ANDASOL TREKKING MAN 9, 6, 5, 4														
	A	B	C	D	E	F	G	H	I	J	K			
S	490	580	145	465	73	69.5	-55	387	630	1115	750	44	90	660
M	530	595	155	465	73	69.5	-55	400	637	1132	785	44	90	660
L	570	610	175	465	73	69.5	-55	410	657	1147	810	44	110	660

ANDASOL TREKKING LADY 9, 6, 5, 4														
	A	B	C	D	E	F	G	H	I	J	K			
S	430	560	130	465	73	69.5	-55	372	615	1095	610	44	90	660
M	470	570	140	465	73	69.5	-55	380	625	1105	605	44	90	660
L	510	580	160	465	73	69.5	-55	382	642	1117	605	44	90	660

ANDASOL WAVE 9, 5														
	A	B	C	D	E	F	G	H	I	J	K			
S	475	590	180	525	74	69.5	-56	400	662	1197	430	44	90	660
M	510	610	185	525	74	69.5	-56	417	667	1217	430	44	90	660

SQUARE CROSS (X) MAN 7, 6, 5, 4, 3, 2														
	A	B	C	D	E	F	G	H	I	J	K			
S	470	580	160	455	73.5	70	-60	391	636	1105	735	44/56	60	660
M	520	595	165	455	72.5	70	-60	393	641	1108	770	44/56	75	660
L	570	610	185	455	72.5	71	-60	400	664	1112	815	44/56	90	660
XL	620	625	205	455	72	71	-60	403	683	1121	855	44/56	105	660

SQUARE CROSS (X) LADY 7, 6, 5, 4, 3, 2														
	A	B	C	D	E	F	G	H	I	J	K			
S	420	560	150	455	73	70.5	-60	368	629	1073	630	44/56	60	660
M	470	575	155	455	72	70.5	-60	369	634	1076	625	44/56	60	660
L	520	590	170	455	72	70.5	-60	379	648	1091	625	44/56	75	660
XL	560	610	185	455	72	70.5	-60	395	662	1112	625	44/56	90	660

SQUARE TREKKING MAN 8														
	A	B	C	D	E	F	G	H	I	J	K			
S	470	580	160	455	73.5	70	-60	391	636	1105	735	44/56	90	660
M	520	595	165	455	72.5	70	-60	393	641	1108	770	44/56	90	660
L	570	610	185	455	72.5	71	-60	400	664	1112	815	44/56	110	660
XL	620	625	205	455	72	71	-60	403	683	1121	855	44/56	110	660

SQUARE TREKKING LADY 8														
	A	B	C	D	E	F	G	H	I	J	K			
S	420	560	150	455	73	70.5	-60	368	629	1073	630	44/56	90	660
M	470	575	155	455	72	70.5	-60	369	634	1076	625	44/56	90	660
L	520	590	170	455	72	70.5	-60	379	648	1091	625	44/56	90	660
XL	560	610	185	455	72	70.5	-60	395	662	1112	625	44/56	90	660

SQUARE TREKKING MAN 7, 6, 5, 4, 2														
	A	B	C	D	E	F	G	H	I	J	K			
S	470	580	160	455	73.5	70	-60	391	636	1105	735	44/56	90	660
M	520	595	165	455	72.5	70	-60	393	641	1108	770	44/56	90	660
L	570	610	185	455	72.5	71	-60	400	664	1112	815	44/56	110	660
XL	620	625	205	455	72	71	-60	403	683	1121	855	44/56	110	660

SQUARE TREKKING LADY 7, 6, 5, 4, 2														
	A	B	C	D	E	F	G	H	I	J	K			
S	420	560	150	455	73	70.5	-60	368	629	1073	630	44/56	90	660
M	470	575	155	455	72	70.5	-60	369	634	1076	625	44/56	90	660
L	520	590	170	455	72	70.5	-60	379	648	1091	625	44/56	90	660
XL	560	610	185	455	72	70.5	-60	395	662	1112	625	44/56	90	660

SQUARE TREKKING MAN 3, 1														
	A	B	C	D	E	F	G	H	I	J	K			
S	470	580	160	455	73.5	70	-60	391	636	1105	735	44/56	95	660
M	520	595	165	455	72.5	70	-60	393	641	1108	770	44/56	95	660
L	570	610	185	455	72.5	71	-60	400	664	1112	815	44/56	110	660
XL	620	625	205	455	72	71	-60	403	683	1121	855	44/56	110	660

SQUARE TREKKING LADY 1, 3														
	A	B	C	D	E	F	G	H	I	J	K			
S	420	560	150	455	73	70.5	-60	368	629	1073	630	44/56	95	660
M	470	575	155	455	72	70.5	-60	369	634	1076	625	44/56	95	660
L	520	590	170	455	72	70.5	-60	379	648	1091	625	44/56	95	660
XL	560	610	185	455	72	70.5	-60	395	662	1112	625	44/56	95	660

SQUARE URBAN (X) MAN 2, 4, 6, 8, 9														
	A	B	C	D	E	F	G	H	I	J	K			
S	470	580	160	455	73.5	70	-60	391	636	1105	735	44/56	60	680
M	520	595	165	455	72.5	70	-60	393	641	1108	770	44/56	75	680
L	570	610	185	455	72.5	71	-60	400	664	1112	815	44/56	90	680
XL	620	625	205	455	72	71	-60	403	683	1121	855	44/56	105	680

SQUARE URBAN (X) LADY 8, 6, 4, 2														
	A	B	C	D	E	F	G	H	I	J	K			
S	420	560	150	455	73	70.5	-60	368	629	1073	630	44/56	60	680
M	470	575	155	455	72	70.5	-60	369	634	1076	625	44/56	60	680
L	520	590	170	455	72	70.5	-60	379	648	1091	625	44/56	75	680
XL	560	610	185	455	72	70.5	-60	395	662	1112	625	44/56	90	680

NIVOLET TOUR LC 6, 5, 4, 3, 2 / NIVOLET RACE ULC 4, 2														
	A	B	C	D	E	F	G	H	I	J	K			
XXS	450	510	105	405	74	70	-68	366	500	968	685	42/47	80	400
XS	480	518	110	405	73.5	70.5	-68	367	505	968	710	42/47	80	400
S	510	530	130	405	73.5	72	-68	372	530	970	722	42/47	90	400
M	540	545	150	405	73	73	-68	377	552	970	760	42/47	100	400
L	560	560	165	405	73	73.5	-68	385	570	978	783	42/47	110	420
XL	580	575	185	405	72.5	73.5	-68	390	587	987	790	42/47	120	440
XXL	610	590	210	405	72.5	73.5	-68	397	612	1002	820	42/47	120	440

NIVOLET TOUR 3, 2														
	A	B	C	D	E	F	G	H	I	J	K			
XS	460	518	120	412	74.5	71.5	-67	375	515	977	695	42/47	80	380
S	490	530	140	412	74	72	-67	377	535	981	720	42/47	90	400
M	520	546	160	412	73	72.5	-67	376	555	982	745	42/47	100	400
L	550	565	180	412	73	72.5	-67	383	575	991	775	42/47	110	420
XL	580	585	200	412	72	73	-67	392	595	1005	800	42/47	120	440

NIVOLET TOUR DISC LC 3, 2														
	A	B	C	D	E	F	G	H	I	J	K			
XS	460	520	120	415	74.5	71.5	-67	375	515	980	675	42/47	80	380
S	490	530	140	415	74	72	-67	380	535	984	700	42/47	90	400
M	520	545	160	415	73	72.5	-67	380	555	982	730	42/47	100	400
L	550	565	180	415	72.5	73	-67	385	575	994	760	42/47	110	420
XL	580	585	200	415	72	73	-67	390	595	1008	785			

USAGE REGULATIONS

ENG

GHOST USE CONDITION TABLE

There are many types of bicycles, and each bicycle type is designed for a specific use, or use condition. This section explains those conditions and weight limits: the total weight of rider, gear, and bicycle. If you are not sure what type of bicycle you have, please consult our service team. If your use of a bicycle applies more stress than the limit of your bicycle's design, this could reduce the life of, and/or cause damage to the bicycle, or part of the bicycle.

	TERRAIN	WEIGHT LIMIT*	BIKE TYPE OR DEFINITION
POWERKID 16, 12, POWERKIDDY 12	Riding for children. A child should not ride without the supervision of a parent. Children should not ride near slopes, curbs, stairs, drop-offs, pools, or areas used by automobiles.	40 kg	Maximum saddle height of 635 mm. Usually a bicycle with 12" or 16" wheels No quick-release wheel attachment systems
NIVOLET	CONDITION 1: Riding on a paved surface where the tires are always on the ground.	120 kg	Road bicycle with drop-type handlebar
POWERKID 24, 20		60 kg	Usually a bicycle for children with 20" or 24" wheels
LECTOR, HTX, HTX EBS, NILA, LANAQ, KATO, KATO X, TACANA, TACANA X, SQUARE URBAN, SQUARE CROSS, SONA, LAWU		120 kg	Cross-country hardtail mountain- or cross bike
TERU, ANDASOL CROSS	CONDITION 2: Riding in Condition 1, plus smooth gravel roads and groomed trails with low-angle grades. Drop-offs of less than 15 cm.		Pedelec (EPAC) Hardtail mountain- or cross bike
SQUARE TREKKING, SQUARE URBAN X, SQUARE CROSS X, ANDASOL		140 kg	EPAC or Bicycle with 700c wheels, tires wider than 28c, and flat or comfort handlebar Urban or City bicycle with special equipment such as fenders or light for use on public roads
TERU FS, TERU FS X			EPAC full suspension mountain bike
RIOT, SLAMR, AMR, LANAQ FS, KATO FS, ASKET, THE HOOD PRO, THE HOOD FS	CONDITION 3: Riding in Conditions 1 and 2, plus rough trails, small obstacles, and technical terrain. Jumps should be no more than 60 cm.		All-mountain tour or singletrack trail mountain bike with wide, knobby 26", 27.5", or 29" tires.
FRAMR, PATHRIOT, SLAMR X	CONDITION 4: Riding in Conditions 1, 2 and 3, plus rough technical terrain and obstacles of moderate height. Jumps should be no more than 120 cm.	120 kg	Heavy-duty, technical trail or all-mountain trail, mountain bike with wide, knobby 26", 27.5", or 29" tires

*ADDITIONAL INFORMATION REGARDING MAXIMUM ALLOWABLE WEIGHT

Please also note wheel set and rim manufacturer restrictions!

WARNING

If your use of a bicycle applies more stress than the use condition for which it is intended, the bicycle and/or its parts can be damaged or may break. A bicycle that is damaged may limit your control and cause you to fall. Do not ride in use conditions that apply more stress than the limits of the bicycle. If you are not sure, consult your GHOST service department.

CRASH REPLACEMENT

You can claim our frame crash replacement service if an accident or fall causes such damage to a GHOST frame that continued riding is impossible. Contact the GHOST service department for detailed information.

BICYCLE WEIGHT

Bicycle weight (approximately) is based on smallest frame size without water bottle cage and pedals. Weights of supplied components subject to change.

EINSATZBEREICH DEFINITION

GER

GHOST EINSATZBEREICH DEFINITION

Unser Produktportfolio bietet viele verschiedene Arten von Fahrrädern. Jedes einzelne Fahrrad wurde für einen bestimmten Einsatzbereich entwickelt und gebaut. Dieser Abschnitt erklärt diese Einsatzbereiche im Detail und gibt Auskunft über das maximal zulässige Gesamtgewicht. Dazu zählen: das Körpergewicht des Fahrers, Kleidung sowie Anbauteile. Bei Unklarheiten zu den jeweiligen Kategorien wenden Sie sich bitte an unser Service Team. Überstrapazierungen können die Lebensdauer des Fahrrads oder die Lebensdauer von Anbauteilen verkürzen.

	TERRAIN	MAX. ZULÄSSIGES GESAMTGEWICHT*	BIKETYP ODER DEFINITION
POWERKID 16, 12, POWERKIDDY 12	Fahrbar für Kinder. Kinder dürfen die Räder nicht ohne Aufsicht eines Erziehungsberechtigten nutzen. Kinder sollten nicht in der Nähe von Abhängen, Bordsteinen, Treppen, Gewässern oder im öffentlichen Straßenverkehr fahren.	40 kg	Maximale Sattelhöhe von 635 mm. Kinderfahrrad mit 12" oder 16" Laufräder ohne Schnellspannsystem.
NIVOLET	KATEGORIE 1: Fahrräder der Kategorie 1 sollten ausschließlich auf geteerten oder gepflasterten Straßen und Wegen bewegt werden, wo ein permanenter Bodenkontakt der Räder gewährleistet wird.	120 kg	Renntag mit Rennradlenker
POWERKID 24, 20		60 kg	Kinderfahrrad mit 20" oder 24" Laufräder
LECTOR, HTX, HTX EBS, NILA, LANAQ, KATO, KATO X, TACANA, TACANA X, SQUARE URBAN, SQUARE CROSS, SONA, LAWU	KATEGORIE 2: Fahrräder der Kategorie 2 können zusätzlich zu den in Kategorie 1 genannten Einsatzbereichen auch auf geschotterten und unbefestigten Wegen mit moderater Steigung bewegt werden. In dieser Kategorie kann es in rauherem Terrain zu kurzzeitigem Verlust des Bodenkontakts der Reifen kommen. Die maximale Sprunghöhe von 15 cm sollte mit Fahrrädern der Kategorie 2 nicht überschritten werden.	120 kg	Cross Country Hardtail/Mountain- oder Crossbike
TERU, ANDASOL CROSS			Pedelec (EPAC) Hardtail/Mountain- oder Crossbike
SQUARE TREKKING, SQUARE URBAN X, SQUARE CROSS X, ANDASOL		140 kg	EPAC oder Fahrrad mit 700c Laufrädern, Reifen breiter als 28c und flachen oder Comfortlenkern. Urban oder City Fahrrad mit Spezialausstattung wie z. B. Schutzbleche oder Lichtanlagen für den öffentlichen Straßenverkehr.
TERU FS, TERU FS X			EPAC vollgefedertes Mountainbike
RIOT, SLAMR, AMR, LANAQ FS, KATO FS, ASKET, THE HOOD PRO, THE HOOD FS	KATEGORIE 3: Fahrräder der Kategorie 3 können zusätzlich zu den in den Kategorien 1 und 2 genannten Einsatzbereichen, auch auf rauen Trails, in rauem Gelände und auf schwierigen Strecken, die eine gute Fahrtechnik erfordern, eingesetzt werden. Sprünge bis zu einer Höhe von max. 60 cm können mit diesen Fahrrädern bewältigt werden.		All-Mountain Tour oder Singletrack Trail. Mountainbike mit breiten 26", 27,5" oder 29" Stollenreifen.
FRAMR, PATHRIOT, SLAMR X	KATEGORIE 4: Fahrräder der Kategorie 4 können zusätzlich zu den in den Kategorien 1, 2 und 3 genannten Einsatzbereichen auch für Abfahrten in rauem Gelände eingesetzt werden. Sprünge bis zu einer Höhe von max. 120 cm können mit den Fahrrädern der Kategorie 4 bewältigt werden.	120 kg	„Heavy-duty“, Technical Trail oder All-Mountain Trail, Mountainbike mit breiten 26", 27,5" oder 29" Stollenreifen.

*HINWEIS ZUM ZULÄSSIGEN GESAMTGEWICHT

Beachten Sie unbedingt auch Einschränkungen unserer Zulieferfirmen!

ACHTUNG

Wenn ein Fahrrad höheren Belastungen ausgesetzt wird, als von uns in der jeweiligen Kategorie empfohlen, kann es zu Beschädigungen des Materials und sogar zum Bruch führen. Ein beschädigtes Fahrrad ist nicht mehr kontrollierbar und kann schwere Stürze verursachen. Verwenden Sie ein Fahrrad daher nur in dem vom uns zugelassenen Einsatzbereich. Bei Unsicherheiten wenden Sie sich bitte an unser Service Team.

CRASH REPLACEMENT

Sollte ein GHOST Rahmen nach einem Unfall oder Sturz so beschädigt sein, dass dieser nicht mehr fahrbar ist, kann unser Crash Replacement in Anspruch genommen werden. Bitte kontaktieren Sie die GHOST Service Abteilung für nähere Informationen.

FAHRRADGEWICHT

Alle Gewichtsangaben sind circa Angaben bei kleinster Rahmenhöhe ohne Flaschenhalter und Pedale. Gewichtsänderungen seitens unserer Zulieferfirmen können nicht berücksichtigt werden.



IMPRINT

ENG

COVER PHOTO

Jan Kasl

ENGLISH EDIT

Lars-Erik Johnson | Verde Brand Communications, Martina Teske

GERMAN EDIT

Andrea Kohndorfer, Karin Bünagel

THANKS TO

All employees of GHOST-Bikes – to each one of you in our unique company who was a part of this long and sometimes difficult development process of our 2016 products which we now proudly present.

We are not liable for errors, changes or misprints.
Images might not represent the original.

© 2015 GHOST Bikes

Under certain circumstances, not all of the products shown in this catalogue might be available in all regions. Please contact your GHOST sales department for more information.

GER

Cover PHOTO

Jan Kasl

ENGLISCHE TEXTBEARBEITUNG

Lars-Erik Johnson | Verde Brand Communications, Martina Teske

DEUTSCHE TEXTBEARBEITUNG

Andrea Kohndorfer, Karin Bünagel

DANK AN

Alle Mitarbeiter von GHOST-Bikes – jeden Einzelnen in unserer einmaligen Firma, der ein Teil dieses langen und manchmal auch harten Entwicklungsprozesses der 2016er-Produkte war, die wir nun mit Stolz präsentieren.

Irrtümer, Änderungen und Druckfehler vorbehalten.
Bilder können vom Original abweichen.

© 2015 GHOST Bikes

Unter Umständen sind nicht alle in diesem Katalog gezeigten Produkte in allen Regionen erhältlich, bitte kontaktieren Sie dazu Ihr GHOST Vertriebs-Team.

GHOST-Bikes GmbH

An der Tongrube 3
95652 Waldsassen
Germany

Tel: +49 (9632) 9255-0
Fax: +49 (9632) 9255-16
Email: info@ghost-bikes.de
web: ghost-bikes.com

Member of Accell Group

