

GHOST



2024

INHALT/INDEX

STORY TIME

BRAND	2
RANGE	4
SIDE BY SIDE	6
HIGHLIGHT LECTOR	8
HIGHLIGHT ASKET CF	10

PATH BIKES

PATH RIOT	12
PATH ASKET	18

E-BIKES

E-RIOT	22
E-ASX	38
E-TERU	44

BIKES

ASKET	66
RIOT	86
LECTOR	100
NIRVANA	110
KATO	120
LANAO	140
YOUTH	150
KIDS	158
SQUARE	184

P&A

MOTORS	196
XLC PRODUCTS	198
BIKEPARTS	200
SCHALTAUGENÜBERSICHT	206
STÄNDERÜBERSICHT	206

INFO

LEGENDE SPEC ICONS	210
GEOMETRIEN	212
TECHNIK LEXIKON	242
EINSATZBEREICHE	244

BUILT
FOR THE
ROUGH



GHOST

***WE LIVE FOR YOU TO DOMINATE EVERYTHING
THE MOUNTAIN HAS TO OFFER, GIVING YOU
THE PERFORMANCE, THE ENVIRONMENT AND
THE STROKE TO ATTACK ANY ADVENTURE
WITH CONFIDENCE.***

***DEIN ZIEL IST UNSER CREDO: ALLES ZU MEISTERN, WAS DER BERG ZU BIETEN HAT.
WIR STELLEN DIE RICHTIGEN RAHMENBEDINGUNGEN, SCHÜREN DIE BEGEISTERUNG UND
BIETEN DIR DIE PERFORMANCE, UM JEDES ABENTEUER DA DRAUSSEN SICHER ZU BEWÄLTIGEN.***

1

**MTB
EXPERIENCE**

MTBs and E-Bikes which open the door to mountainbiking and more.

2

RACE

Highend, light Worldcup XC-Bikes with a unique design. Developed for worldclass athletes, marathons and weekend racers.

3

GRAVITY

Bikes with dynamic suspension systems for DH, FR, EN, AM, Trail and Touring. For endless rides, available as E- and non E-Bikes.

4

FREEDOM

Lightweight, fast and all-purpose: Gravel bikes are the "do it all" bikes and are also perfect for any kind of bikepacking adventure.

5

COMMUTE

Clean, practical and lightweight bikes for urban lifestyle as well as long distance bikes for day trips and travel adventures.

MTBs und E-Bikes, die neue
Welten eröffnen:
Mountainbiking und mehr.

*E-TERU
NIRVANA
KATO FS
KATO
LANAO
KIDS
YOUTH*

Hochwertige, leichte
Worldcup XC-Bikes mit
einem einzigartigen Design.
Entwickelt für Weltklasse-
athleten, Marathons und
Wochenend-Racer.

*LECTOR
LECTOR FS*

Bikes mit dynamischen
Federungssystemen für DH,
FR, EN, AM, Trail und Touring.
Für unbegrenztes Fahren sind
Bikes erhältlich als E-Bike und
Nicht-E-Bike.

*E-ASX
E-RIOT
PATH RIOT
RIOT*

Leicht, schnell und
universell einsetzbar:
Gravelbikes sind die
„Alleskönner“ unter den
Fahrrädern und eignen sich
auch für jede Art von
Bikepacking-Abenteuer.

*PATH ASKET
ASKET*

Praktische und leichte
Fahrräder mit cleanem
Design für den urbanen
Lebensstil sowie
Langstreckenräder
für Tagesausflüge
und Reiseabenteuer.

*SQUARE
E-TERU EQ*

**R
A
M
G
E**

SIDE BY *S*IDE

***DURING THE ENTIRE DEVELOPMENT PHASE,
THE PATH RIOT AND RIOT CF STOOD TOGETHER.
AT EYE LEVEL. EQUALLY IMPORTANT. SIDE BY SIDE.
NO COMPROMISES. SAME SPECS ON BOTH BIKES.
FOR US, PERFORMANCE AND HANDLING
ALWAYS CAME FIRST.***

***WÄHREND DER GESAMTEN ENTWICKLUNGSPHASE GAB ES DAS PATH RIOT UND RIOT CF
NUR GEMEINSAM. AUF AUGENHÖHE. GLEICH WICHTIG. SEITE AN SEITE.
KEINE KOMPROMISSE. GLEICHE SPECS BEI BEIDEN RÄDERN. FÜR UNS STANDEN
PERFORMANCE UND HANDLING IMMER AN ERSTER STELLE.***





GHOST

**FOR RACING.
FOR XC.
FOR YOU.**



GHOST

LECTOR

**PURE PASSION – THAT’S CROSS COUNTRY RACING.
THAT’S THE DNA OF THE NEW LECTOR WC 30TH.
OUTSTANDING PERFORMANCE, HIGHER STIFFNESS
AND MINIMAL WEIGHT ENSURE MAXIMUM EFFICIENCY
AND PROPULSION.**

**LEIDENSCHAFT PUR – DAS IST CROSS COUNTRY RACING. DAS IST DIE DNA DES
NEUEN LECTOR WC 30TH. HERAUSRAGENDE PERFORMANCE, HÖHERE STEIFIGKEIT
UND MINIMALES GEWICHT SORGEN FÜR MAXIMALE EFFIZIENZ UND VORTRIEB.**







ASKET

**READY FOR THE NEXT
ADVENTURE WITH OUR NEW ASKET CF?
WHATEVER IT MIGHT BE, WE'RE HERE TO GIVE
YOU THE CONFIDENCE TO APPROACH ALL THOSE
PROJECTS, SPINNING AROUND YOUR HEAD.**

**BEREIT FÜR DAS NÄCHSTE ABENTEUER MIT DEM NEUEN ASKET CF?
WAS ES AUCH IMMER SEIN MAG, WIR GEBEN DIR DAS NÖTIGE
SELBSTVERTRAUEN, ALLE DEINE TRAUMPROJEKTE ANZUGREIFEN.**



**INCREASED STIFFNESS
OF BOTTOM BRACKET**



EFFICIENT PEDALLING

SHORTENED CHAINSTAYS

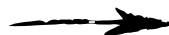

INCREASED TRACTION

**NEW SUPERFIT
GRAVEL GEOMETRY**



**NEXT GRAVEL LEVEL
RIDING EXPERIENCE**

GHOST



PATH BIKES

PATH RIOT

PATH ASKET

rawcarbon/silver - glossy

- FAZUA
- 430 Wh
- +210 mm READY
- LC
- 160 / 140
- TUBE LESS
- PEPS PIN
- USB
- ONE-PIECE
- TRACTION LINK
- EIGHT PINS

SUPER FIT
by GHOST



PATH RIOT „30“

Path Riot CF

Rock Shox ZEB Ultimate 160 mm

Rock Shox Super Deluxe Ultimate RC2T 140 mm

Truvativ Descendant 35 mm

Truvativ Descendant Riser Carbon Downhill 35 mm 800/25 mm

SRAM X0 Eagle Transmission 12-S

SRAM AXS Pod Controller

Rotor 34T

SRAM CS XS 1295 T-Type 10-52

SRAM Code Ultimate Stealth 220 / 200 mm

DT Swiss HXC 1501 Spline One LS 30 mm 15x110 mm //
DT Swiss HXC 1501 Spline One LS 30 mm 12x148 mm

Eightpins hydraulic 34.9 mm

Prologo Proxim W450 Performance

Acros Blocklock 135° AZX-582

SRAM UDH

Prologo X-Shred

Maxxis Assegai 3C MaxxGrip Exo+ 2.5 //
Maxxis Dissector 3C MaxxGrip Double Down 2.4

Fazua LED Hub

Fazua Ride 60

Fazua Energy Fix 430 Wh

Fazua Charger 3A

GRÖSSE	ARTIKELNUMMER	LAUFRADGRÖSSE
S	24PR1013	29
M	24PR1014	29
L	24PR1015	29
XL	24PR1016	29





warm grey / dark chocolate - glossy



PATH RIOT FULL PARTY

PATH RIOT CF

Fox 38 Float Factory GRIP2 eMTB+ 160 mm

Fox Float X2 Factory 140 mm

Ground Fiftyone Dia. 31.8 mm

Ground Fiftyone Dia. 31.8 mm 760/15 (S) 800/27 (M-XL)

Shimano XTR RD-M9100 12-S

Shimano XTR SL-M9100

Rotor 34T

Shimano XT CS-M8100 10-51

Formula Cura 4 203 mm Disc

Syntace W33i 15x110 mm //
Syntace W33i 12x148 mm

Eightpins hydraulic 34.9 mm

WTB Volt

Acros Blocklock 135° AZX-582

SRAM UDH

WTB Wafel

Maxxis Assegai 3C MaxxGrip Exo+ 2.5 //
Maxxis Dissector 3C MaxxGrip Double Down 2.4

Fazua LED Hub

Fazua Ride 60

Fazua Energy 430 Wh

Fazua Charger 3A

GRÖSSE	ARTIKELNUMMER	LAUFRADGRÖSSE
S	31PR1007	29
M	31PR1008	29
L	31PR1009	29
XL	31PR1010	29



grey 1 / pearl light grey - glossy

SUPER FIT
by GHOST



PATH BIKES

PATH RIOT ADVANCED

PATH RIOT CF

Fox 38 Float Performance eMTB+ 160 mm

Fox Float X2 Performance 140 mm

Ground Fiftyone Dia. 31.8 mm

Ground Fiftyone Dia. 31.8 mm 760/15 (S) 800/27 (M-XL)

Shimano XT RD-M8100 12-S

Shimano SLX SL-M7100

Rotor 34T

Shimano Deore CS-M6100 10-51

Formula Cura 4 203 mm Disc

Eightpins hydraulic 34.9 mm

WTB Volt

Acros Blocklock 135° AZX-582

SRAM UDH

WTB Wafel

Maxxis Assegai 3C MaxxGrip Exo+ 2.5 //
Maxxis Dissector 3C MaxxGrip Double Down 2.4

WTB ST Light i30 //
WTB ST Light i30

DT Swiss 370 Classic 15x110 mm

DT Swiss 370 Classic 12x148 mm

Fazua LED Hub

Fazua Ride 60

Fazua Energy 430 Wh

Fazua Charger 3A

GRÖSSE	ARTIKELNUMMER	LAUFRADGRÖSSE
S	31PR1001	29
M	31PR1002	29
L	31PR1003	29
XL	31PR1004	29



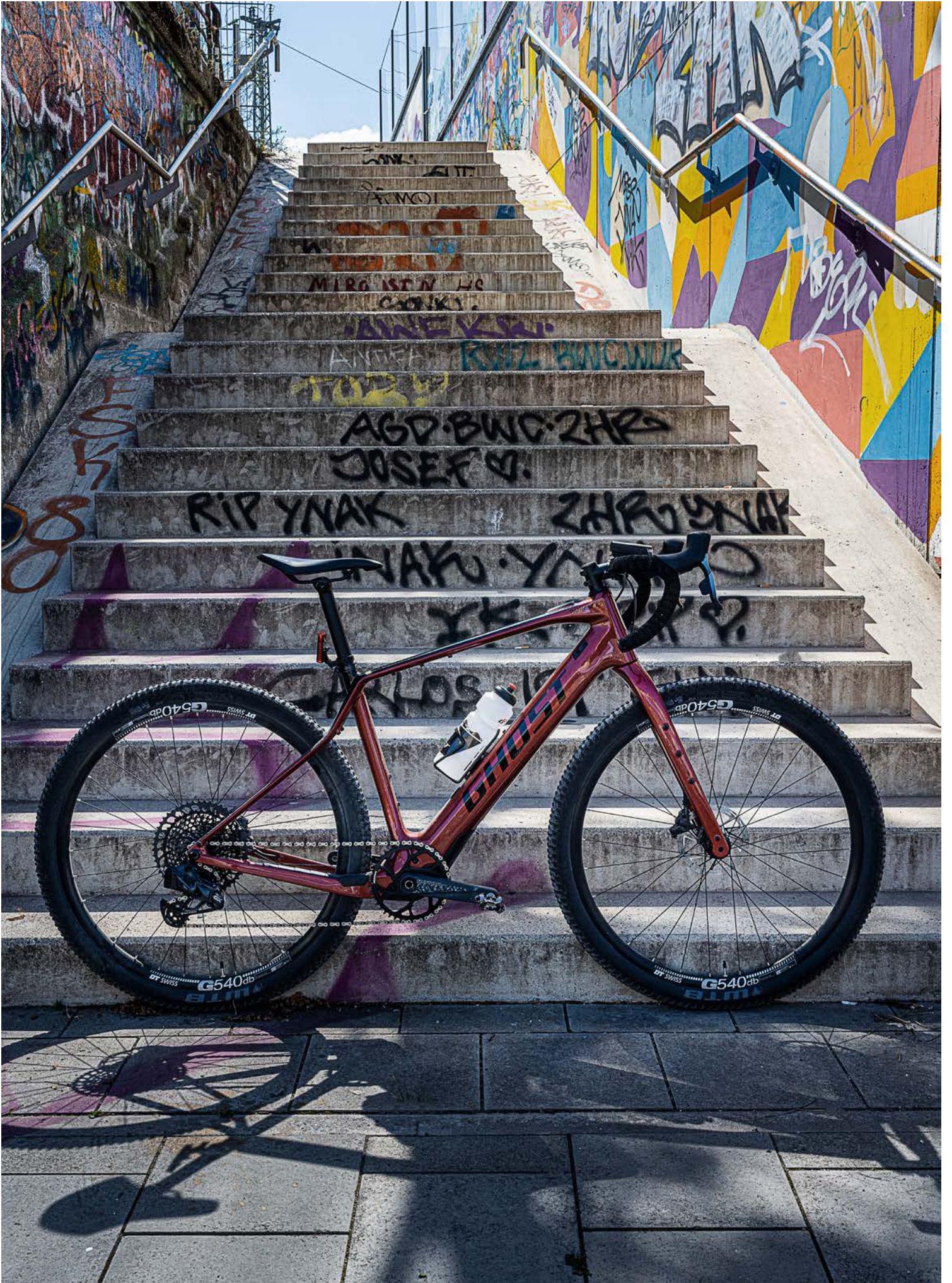

PATH BIKES

PATH RIOT

PATH ASKET

met. rust red / black - glossy



SUPER FIT
by GHOST



PATH ASKET PRO

PATH ASKET LC

GHOST Carbon

Ground Fiftyone Dia. 31.8 mm

Gravel Bar RA120A 440 mm (S) 460 mm (M) 480 mm (L) 500 mm (XL)

SRAM GX Eagle AXS 12-S

SRAM Rival eTap AXS

Rotor 42T

SRAM XG 1295 10-52

SRAM Rival 160 mm Disc

Rock Shox Reverb AXS 31.6 mm 100 mm (S/M) 125 mm (L/XL)

Selle Royal SRX

Acros

GW UDH

Fizik Tempo Bondcrush

WTB Ranger 2.0 TCS Light/Fast //
WTB Ranger 2.0 TCS Light/Fast

DT Swiss G540 24 mm //
DT Swiss G540 24 mm

DT Swiss 350 Classic 12x100 mm

DT Swiss 350 Classic 12x148 mm

Fazua LED Hub

Fazua Ride 60

Fazua Energy 430 Wh

Fazua Charger 3A

GRÖSSE	ARTIKELNUMMER	LAUFRADGRÖSSE
S	31PA1007	29
M	31PA1008	29
L	31PA1009	29
XL	31PA1010	29



carbon / pearl warm grey - glossy

SUPER FIT
by GHOST



PATH BIKES

PATH ASKET ADVANCED

PATH ASKET LC	Shimano GRX BR-RX810 160 mm Disc	Shimano HB-RS470 12x100 mm
Rock Shox Rudy Base 40 mm	JD YSP15DL 31.6 mm 100 mm (S/M) 125 mm (L/XL)	Shimano FH-MT400-B 12x148 mm
Ground Fiftyone Dia. 31.8 mm	Selle Royal SRX	Fazua LED Hub
Gravel Bar RA120A 440 mm (S) 460 mm (M) 480 mm (L) 500 mm (XL)	Acros AZX-203	Fazua Ride 60
Shimano GRX RD-RX812 11-S	GW UDH	Fazua Energy 430 Wh
Shimano GRX ST-RX810	Fizik Tempo Bondcrush	Fazua Charger 3A
Rotor 42T	Maxxis Ravenger Exo TR 40-622 // Maxxis Ravenger Exo TR 40-622	
Shimano XT CS-M8000 11-42	WTB ST i25 // WTB ST i25	

GRÖSSE	ARTIKELNUMMER	LAUFRADGRÖSSE
S	31PA1001	29
M	31PA1002	29
L	31PA1003	29
XL	31PA1004	29





E-BIKES

- | E-RIOT
- E-ASX
- E-TERU

grey / black - matt / glossy

SUPER FIT
by GHOST



E-RIOT EN FULL PARTY

E-RIOT AL

Fox 38 Float Factory GRIP2 eMTB+ 170 mm

Fox DHX2 Factory 160 mm

Race Face Aeffect R Dia. 35 mm

Race Face Aeffect R Dia. 35 mm 780/20

Shimano XT RD-M8100 12-S

Shimano XT SL-M8100

e*thirteen e*spec Plus 34T

Shimano XT CS-M8100 10-51

Formula Cura 4 203 mm Disc

DT Swiss H1900 Spline 30 mm 15x110 mm //
DT Swiss H1900 Spline 30 mm 12x148 mm

Ghost Alpha 1 34.9 mm 125 (S) 150 (M) 170 (L/XL)

Fizik Terra Aidon

Acros Blocklock 135° AZX-582

SRAM UDH

Race Face Half Nelson

Maxxis Assegai 3C MaxxGrip Exo+ 2.5 (S 27,5"; M-XL 29") //
Maxxis Minion DHR II 3C MaxxTerra Exo+ 2.6 (S 27,5"; M-XL 29")

Bosch Kiox 300

Bosch Performance Line CX-R

Bosch Power Tube 750 Wh

Bosch Charger 4 Ah

GRÖSSE	ARTIKELNUMMER	LAUFRADGRÖSSE
S	31ER1039	27,5
M	31ER1040	29
L	31ER1041	29
XL	31ER1042	29





met. azur blue / dark blue - glossy

SUPER FIT
by GHOST



E-RIOT EN PRO

E-RIOT AL

Fox 38 Float Performance eMTB+ 170 mm

Fox DHX Performance 160 mm

Ground Fiftyone Dia. 31.8 mm

Ground Fiftyone Dia. 31.8 mm 760/15 (S) 780/25 (M-XL)

Shimano XT RD-M8100 12-S

Shimano XT SL-M8100

e*thirteen e*spec Plus 34T

Shimano SLX CS-M7100 10-51

Shimano Deore BR-M6120 203 mm Disc

Ghost Alpha 1 34.9 mm 125 (S) 150 (M) 170 (L/XL)

Fizik Terra Aidon

Acros Blocklock 135° AZX-582

SRAM UDH

WTB Wafel

Maxxis Assegai 3C MaxxGrip Exo+ 2.5 (S 27,5"; M-XL 29") //
Maxxis Minion DHR II 3C MaxxTerra Exo+ 2.6 (S 27,5"; M-XL 29")

WTB ST i30 //
WTB ST i30

DT Swiss 370 Classic 15x110 mm

DT Swiss 370 Classic 12x148 mm

Bosch Kiox 300

Bosch Performance Line CX

Bosch Power Tube 750 Wh

Bosch Charger 4 Ah

GRÖSSE	ARTIKELNUMMER	LAUFRADGRÖSSE
S	31ER1033	27.5
M	31ER1034	29
L	31ER1035	29
XL	31ER1036	29



dark green / met. green - glossy



E-RIOT EN UNIVERSAL

E-RIOT AL

Rock Shox ZEB Base 170 mm

Rock Shox Super Deluxe Coil Select R 160 mm

Ground Fiftyone Dia. 31.8 mm

Ground Fiftyone Dia. 31.8 mm 760/15 (S) 780/25 (M-XL)

SRAM GX Eagle 12-S

SRAM GX Eagle Single Click

e*thirteen e*spec Plus 34T

SRAM PG-1230 11-50

SRAM DB8 200 mm Disc

Ghost Alpha 1 34.9 mm 125 (S) 150 (M) 170 (L/XL)

Fizik Terra Aidon

Acros Blocklock 135° AZX-582

SRAM UDH

WTB Wafel

Maxxis Assegai 3C MaxxGrip Exo+ 2.5 (S 27,5"; M-XL 29") //
Maxxis Minion DHR II 3C MaxxTerra Exo+ 2.6 (S 27,5"; M-XL 29")

WTB ST i30 //
WTB ST i30

Shimano HB-MT400-B 15x110 mm

Shimano FH-MT400-B 12x148 mm

Bosch Kiox 300

Bosch Performance Line CX

Bosch Power Tube 750 Wh

Bosch Charger 4 Ah

GRÖSSE	ARTIKELNUMMER	LAUFRADGRÖSSE
S	31ER1027	27,5
M	31ER1028	29
L	31ER1029	29
XL	31ER1030	29



black/silver - glossy

SUPER FIT
by GHOST



E-RIOT AM „30“

E-RIOT CF

Rock Shox ZEB Ultimate 160 mm

Rock Shox Super Deluxe Ultimate RC2T 160 mm

Truvativ Descendant 35 mm

Truvativ Descendant Riser Carbon Downhill 35 mm 800/25 mm

SRAM X0 Eagle Transmission 12-S

SRAM AXS Pod Controller

Race Face Era-E 36T

SRAM CS XS 1295 T-Type 10-52

SRAM Code Ultimate Stealth 220 / 200 mm

DT Swiss HX1501 Spline One 30 mm 15x110 mm //
DT Swiss HX1501 Spline One 30 mm 12x148 mm

Eightpins hydraulic 34.9 mm

Prologo Proxim W450 Performance

Acros Blocklock 135° AZX-582

SRAM UDH

Prologo X-Shred

Maxxis Minion DHF 3C MaxxTerra Exo+ 2.5 //
Maxxis Minion DHR II 3C MaxxTerra Double Down 2.4

Bosch Kiox 300

Bosch Performance Line CX

Bosch Power Tube 750 Wh

Bosch Charger 4 Ah

GRÖSSE	ARTIKELNUMMER	LAUFRADGRÖSSE
S	24ER1023	27.5
M	24ER1024	29
L	24ER1025	29
XL	24ER1026	29



met. turquoise / black - matt

SUPER FIT
by GHOST



E-RIOT AM PRO

E-RIOT CF

Rock Shox ZEB Select 160 mm

Rock Shox Super Deluxe Select R 160 mm

Ground Fiftyone Dia. 31.8 mm

Ground Fiftyone Dia. 31.8 mm 760/15 (S) 780/25 (M-XL)

SRAM GX Eagle 12-S

SRAM NX Eagle Single Click

e*thirteen e*spec Plus 34T

SRAM PG-1230 11-50

Shimano BR-MT520 203 mm Disc

Ghost Alpha 1.34.9 mm 125 (S) 150 (M) 170 (L/XL)

Fizik Terra Aidon

Acros Blocklock 135° AZX-582

SRAM UDH

WTB Wafel

Maxxis Minion DHF 3C MaxxTerra Exo+ 2.5 (S 27.5"; M-XL 29") // Maxxis Minion DHR II 3C MaxxTerra Exo+ 2.6 (S 27.5"; M-XL 29")

WTB ST i30 // WTB ST i30

Shimano HB-MT400-B 15x110 mm

Shimano FH-MT400-B 12x148 mm

Bosch Kiox 300

Bosch Performance Line CX

Bosch Power Tube 750 Wh

Bosch Charger 4 Ah

GRÖSSE	ARTIKELNUMMER	LAUFRADGRÖSSE
S	31ER1045	27.5
M	31ER1046	29
L	31ER1047	29
XL	31ER1048	29



silver/black - glossy

SUPER FIT
by GHOST



E-RIOT AM ADVANCED

E-RIOT CF

Rock Shox Psyto Silver RC 160 mm

Rock Shox Super Deluxe Select R 160 mm

Ghost Dia. 31.8 mm

Ghost MTB Dia. 31.8 mm 800/15 mm

SRAM SX Eagle 12-S

SRAM SX Eagle Single Click

e*thirteen e*spec Plus 34T

SRAM PG-1210 11-50

Shimano BR-MT520 203 mm

Ghost Alpha 1 34.9 mm 125 (S) 150 (M) 170 (L/XL)

Fizik Terra Aidon

Acros Blocklock 135° AZX-582

SRAM UDH

WTB Wafel

Maxxis Minion DHF 3C MaxxTerra Exo+ 2.5 //
Maxxis Minion DHR II 3C MaxxTerra Exo+ 2.6

WTB ST i30 //
WTB ST i30

Shimano HB-TC500-15-B 15x110 mm

Shimano FH-TC500-HM-B 12x148 mm

Bosch Kiox 300

Bosch Performance Line CX

Bosch Power Tube 750 Wh

Bosch Charger 4 Ah

GRÖSSE	ARTIKELNUMMER	LAUFRADGRÖSSE
S	24ER1012	27.5
M	24ER1013	29
L	24ER1014	29
XL	24ER1015	29





metallic dark brown/metallic black blue - glossy



SUPER FIT
by GHOST



E-RIOT AM ADVANCED

E-RIOT CF

Rock Shox Psyto Silver RC 160 mm

Rock Shox Super Deluxe Select R 160 mm

Ghost Dia. 31.8 mm

Ghost MTB Dia. 31.8 mm 800/15 mm

SRAM SX Eagle 12-S

SRAM SX Eagle Single Click

e*thirteen e*spec Plus 34T

SRAM PG-12110 11-50

Shimano BR-MT520 203 mm

Ghost Alpha 1 34.9 mm 125 (S) 150 (M) 170 (L/XL)

Fizik Terra Aidon

Acros Blocklock 135° AZX-582

SRAM UDH

WTB Wafel

Maxxis Minion DHF 3C MaxxTerra Exo+ 2.5 //
Maxxis Minion DHR II 3C MaxxTerra Exo+ 2.6

WTB ST i30 //
WTB ST i30

Shimano HB-TC500-15-B 15x110 mm

Shimano FH-TC500-HM-B 12x148 mm

Bosch Kiox 300

Bosch Performance Line CX

Bosch Power Tube 750 Wh

Bosch Charger 4 Ah

GRÖSSE	ARTIKELNUMMER	LAUFRADGRÖSSE
S	24ER1018	27.5
M	24ER1019	29
L	24ER1020	29
XL	24ER1021	29



dark grey / black - matt

SUPER FIT
by GHOST



E-RIOT AM UNIVERSAL

E-RIOT AL

Fox 38 Float Performance eMTB+ 160 mm

Fox Float X Performance 160 mm

Ground Fiftyone Dia. 31.8 mm

Ground Fiftyone Dia. 31.8 mm 760/15 (S) 780/25 (M-XL)

Shimano XT RD-M8100 12-S

Shimano SLX SL-M7100

e*thirteen e*spec Plus 34T

Shimano SLX CS-M7100 10-51

Shimano Deore BR-M6120 203 mm Disc

Ghost Alpha 1 34.9 mm 125 (S) 150 (M) 170 (L/XL)

Fizik Terra Aidon

Acros Blocklock 135° AZX-582

SRAM UDH

WTB Wafel

Maxxis Minion DHF 3C MaxxTerra Exo+ 2.5 (S 27,5"; M-XL 29") // Maxxis Minion DHR II 3C MaxxTerra Exo+ 2.6 (S 27,5"; M-XL 29")

WTB ST i30 // WTB ST i30

Shimano HB-MT400-B 15x110 mm

Shimano FH-MT410-B 12x148 mm

Bosch Kiox 300

Bosch Performance Line CX

Bosch Power Tube 750 Wh

Bosch Charger 4 Ah

GRÖSSE	ARTIKELNUMMER	LAUFRADGRÖSSE
S	31ER1019	27,5
M	31ER1020	29
L	31ER1021	29
XL	31ER1022	29





black / pearl deep red - glossy

SUPER FIT
by GHOST



E-RIOT AM ESSENTIAL

E-RIOT AL

Rock Shox 35 Gold RL 160 mm

Rock Shox Super Deluxe Select+ RT 160 mm

Ground Fiftyone Dia. 31.8 mm

Ground Fiftyone Dia. 31.8 mm 760/15 (S) 780/25 (M-XL)

SRAM SX Eagle 12-S

SRAM SX Eagle Single Click

e*thirteen e*spec Plus 34T

SRAM PG-1210 11-50

Tektro HD-M750 203 mm Disc

Ghost Alpha 1 34.9 mm 125 (S) 150 (M) 170 (L/XL)

Fizik Terra Aidon

Acros Blocklock 135° AZX-582

SRAM UDH

WTB Wafel

Maxxis Minion DHF 3C MaxxTerra Exo+ 2.5 (S 27,5"; M-XL 29") // Maxxis Minion DHR II 3C MaxxTerra Exo+ 2.6 (S 27,5"; M-XL 29")

WTB ST i30 // WTB ST i30

Shimano HB-MT400-B 15x110 mm

Shimano FH-MT400-B 12x148 mm

Bosch Kiox 300

Bosch Performance Line CX

Bosch Power Tube 625 Wh

Bosch Charger 4 Ah

GRÖSSE	ARTIKELNUMMER	LAUFRADGRÖSSE
S	31ER1013	27,5
M	31ER1014	29
L	31ER1015	29
XL	31ER1016	29



black / pearl dark grey - matt

SUPER FIT
by GHOST



E-RIOT TRAIL ESSENTIAL

E-RIOT AL	SRAM PG-1210 11-50	WTB ST i30 // WTB ST i30
Rock Shox 35 Silver TK Solo Air 150 mm	Shimano BR-MT420 203 mm Disc	Shimano HB-MT400-B 15x110 mm
Rock Shox Super Deluxe Select R 140 mm	Ghost Alpha 1 34.9 mm 125 (S) 150 (M) 170 (L/XL)	Shimano FH-MT400-B 12x148 mm
Ground Fiftyone Dia. 31.8 mm	Fizik Terra Aidon	Bosch Kiox 300
Ground Fiftyone Dia. 31.8 mm 760/15 (S) 780/25 (M-XL)	Acros Blocklock 135° AZX-582	Bosch Performance Line CX
SRAM SX Eagle 12-S	SRAM UDH	Bosch Power Tube 750 Wh
SRAM SX Eagle Single Click	WTB Wafel	Bosch Charger 4 Ah
e*thirteen e*spec Plus 34T	Schwalbe Nobby Nic Performance 2.6 (S 27.5"; M-XL 29") // Schwalbe Nobby Nic Performance 2.6 (S 27.5"; M-XL 29")	

GRÖSSE	ARTIKELNUMMER	LAUFRADGRÖSSE
S	31ER1001	27.5
M	31ER1002	29
L	31ER1003	29
XL	31ER1004	29



E-BIKES

deep grey/metallic dark blue - matt

SUPER FIT
by GHOST



E-RIOT TRAIL

E-RIOT AL

Rock Shox 35 Silver TK Solo Air 150 mm

Rock Shox Super Deluxe Select R 140 mm

Ghost Dia. 31.8 mm

Ghost MTB Dia. 31.8 mm 800/15 mm

SRAM NX Eagle 12-S

SRAM NX Eagle Single Click

Race Face Aeffect R 34T

SRAM PG-1210 11-50

Shimano BR-MT520 203 mm

Ghost Alpha 1 34.9 mm 125 (S) 150 (M) 170 (L/XL)

Prologo Proxim W400 Performance

Acros Blocklock 135° AZX-582

SRAM UDH

Switch Components Kaleido

Schwalbe Nobby Nic Performance 2.6 //
Schwalbe Nobby Nic Performance 2.6

WTB ST i30 //
WTB ST i30

Shimano HB-TC500-15-B 15x110 mm

Shimano FH-TC500-HM-B 12x148 mm

Bosch LED Remote

Bosch Performance Line CX

Bosch Power Tube 625 Wh

Bosch Charger 4 Ah

GRÖSSE	ARTIKELNUMMER	LAUFRADGRÖSSE
S	24ER1001	27.5
M	24ER1002	29
L	24ER1003	29
XL	24ER1004	29



met. bright orange/met. dark brown - glossy

SUPER FIT
by GHOST



E-RIOT TRAIL

E-RIOT AL

Rock Shox 35 Silver TK Solo Air 150 mm

Rock Shox Super Deluxe Select R 140 mm

Ghost Dia. 31.8 mm

Ghost MTB Dia. 31.8 mm 800/15 mm

SRAM NX Eagle 12-S

SRAM NX Eagle Single Click

Race Face Aeffect R 34T

SRAM PG-1210 11-50

Shimano BR-MT520 203 mm

Ghost Alpha 1 34.9 mm 125 (S) 150 (M) 170 (L/XL)

Prologo Proxim W400 Performance

Acros Blocklock 135° AZX-582

SRAM UDH

Switch Components Kaleido

Schwalbe Nobby Nic Performance 2.6 //
Schwalbe Nobby Nic Performance 2.6

WTB ST i30 //
WTB ST i30

Shimano HB-TC500-15-B 15x110 mm

Shimano FH-TC500-HM-B 12x148 mm

Bosch LED Remote

Bosch Performance Line CX

Bosch Power Tube 625 Wh

Bosch Charger 4 Ah

GRÖSSE	ARTIKELNUMMER	LAUFRADGRÖSSE
S	24ER1007	27.5
M	24ER1008	29
L	24ER1009	29
XL	24ER1010	29





E-BIKES

- | E-RIOT
- | E-ASX
- | E-TERU

anthracite / black - glossy



E-ASX 160 UNIVERSAL

E-ASX AL

Rock Shox 35 Gold RL 160 mm

Rock Shox Deluxe Select R 160 mm

Ground Fiftyone Dia. 31.8 mm

Ground Fiftyone Dia. 31.8 mm 760/15 (S) 780/25 (M-XL)

SRAM NX Eagle 12-S

SRAM SX Eagle Single Click

e*thirteen e*spec Plus 34T

SRAM PG-1230 11-50

Shimano BR-MT520 203 mm Disc

Ghost Alpha 1 34.9 mm 125 (S) 150 (M) 170 (L/XL)

Selle Royal Vivo

Acros AZX-205

SRAM UDH

WTb Wafel

Maxxis Minion DHF 3C MaxxTerra Exo+ 2.5 29" // Maxxis Minion DHR II 3C MaxxTerra Exo+ 2.6 27.5"

WTb ST i30 // WTb ST i30

Shimano HB-MT400-B 15x110 mm

Shimano FH-MT400-B 12x148 mm

Bosch LED Remote

Bosch Performance Line CX

Bosch Power Tube 750 Wh

Bosch Charger 4 Ah

GRÖSSE	ARTIKELNUMMER	LAUFRADGRÖSSE
S	31AS1013	
M	31AS1014	
L	31AS1015	
XL	31AS1016	



met. rusted red / black - glossy / matt



E-ASX 160 ESSENTIAL

E-ASX AL

Rock Shox 35 Silver TK Solo Air 160 mm

SR Suntour Raidon R 160 mm

Ground Fiftyone Dia. 31.8 mm

Ground Fiftyone Dia. 31.8 mm 760/15 (S) 780/25 (M-XL)

SRAM SX Eagle 12-S

SRAM SX Eagle Single Click

e*thirteen e*spec Plus 34T

SRAM PG-12110 11-50

Shimano BR-MT420 / 410 203 mm Disc

Ghost Alpha 1 34.9 mm 125 (S) 150 (M) 170 (L/XL)

Selle Royal Vivo

Acros AZX-205

SRAM UDH

WTB Wafel

Maxxis Minion DHF 3C MaxxTerra Exo+ 2.5 29" // Maxxis Minion DHR II 3C MaxxTerra Exo+ 2.6 27.5"

WTB ST i30 // WTB ST i30

Shimano HB-MT400-B 15x110 mm

Shimano FH-MT400-B 12x148 mm

Bosch LED Remote

Bosch Performance Line CX

Bosch Power Tube 625 Wh

Bosch Charger 4 Ah

GRÖSSE	ARTIKELNUMMER	LAUFRADGRÖSSE
S	31AS1019	
M	31AS1020	
L	31AS1021	
XL	31AS1022	





met. anthrazit / light grey - glossy / matt



E-ASX 130 UNIVERSAL

E-ASX AL

SR Suntour XCR34 Air Boost LOR DS 130 mm

SR Suntour Raidon R 130 mm

Ground Fiftyone Dia. 31.8 mm

Ground Fiftyone Dia. 31.8 mm 760/15 (S) 780/25 (M-XL)

SRAM SX Eagle 12-S

SRAM SX Eagle Single Click

e*thirteen e*spec Plus 34T

SRAM PG-1210 11-50

Shimano BR-MT420 203 mm Disc

GHOST SP DC1 31.6 mm

Selle Royal Vivo

Acros AZX-205

SRAM UDH

WTB Wafel

Schwalbe Nobby Nic Performance 2.4 29" //
Schwalbe Nobby Nic Performance 2.6 27.5"

WTB ST i30 //
WTB ST i30

Shimano HB-MT400-B 15x110 mm

Shimano FH-MT400-B 12x148 mm

Bosch LED Remote

Bosch Performance Line CX

Bosch Power Tube 750 Wh

Bosch Charger 4 Ah

GRÖSSE	ARTIKELNUMMER	LAUFRADGRÖSSE
S	31AS1007	
M	31AS1008	
L	31AS1009	
XL	31AS1010	



black / light kaki - matt



E-ASX 130 ESSENTIAL

E-ASX AL

SR Suntour XCM34 Boost DS 130 mm

SR Suntour Raidon R 130 mm

Ground Fiftyone Dia. 31.8 mm

Ground Fiftyone Dia. 31.8 mm 760/15 (S) 780/25 (M-XL)

Shimano CUES RD-U6000 11-S

Shimano CUES SL-U6000-11

e*thirteen e*spec Plus 34T

Shimano CUES CS-LG400-11 11-50

Shimano BR-MT420 / 410 203 mm Disc

GHOSH SP DC1 31.6 mm

Selle Royal Vivo

Acros AZX-205

SRAM UDH

WTB Wafel

Schwalbe Smart Sam 2.35 29" //
Schwalbe Smart Sam 2.6 27.5"

WTB ST i25 //
WTB ST i30

Shimano HB-MT400-B 15x110 mm

Shimano FH-MT400-B 12x148 mm

Bosch LED Remote

Bosch Performance Line CX

Bosch Power Tube 625 Wh

Bosch Charger 4 Ah

GRÖSSE	ARTIKELNUMMER	LAUFRADGRÖSSE
S	31AS1001	
M	31AS1002	
L	31AS1003	
XL	31AS1004	





E-BIKES

- | E-RIOT
- | E-ASX
- | E-TERU

light kaki / black - matt

SUPER FIT
by GHOST



E-TERU PRO

E-TERU AL

Rock Shox 35 Silver TK Solo Air 120 mm

Ground Fiftyone Dia. 31.8 mm

Ground Fiftyone Dia. 31.8 mm 720/20 (XS/S) 740/27 (M-XL)

Shimano XT RD-M8100 12-S

Shimano SLX SL-M7100

Miranda Virage 38T

Shimano SLX CS-M7100 10-51

Shimano BR-MT420 203 mm Disc

Ghost 34.9 mm

Selle Royal Vivo

Feimin H856 + Acros Blocklock

SRAM UDH

MTB Grip

Schwalbe Smart Sam 2.35 (XS-S 27,5"; M-XL 29") //
Schwalbe Smart Sam 2.35 (XS-S 27,5"; M-XL 29")

Schürmann Yak Disc 25 //
Schürmann Yak Disc 25

Shimano HB-MT400-B 15x110 mm

Shimano FH-MT510-B 12x148 mm

Bosch Kiox 300

Bosch Performance Line CX

Bosch Power Tube 750 Wh

Bosch Charger 4 Ah

GRÖSSE	ARTIKELNUMMER	LAUFRADGRÖSSE
XS	31ET1063	27.5
S	31ET1064	27.5
M	31ET1065	29
L	31ET1066	29
XL	31ET1067	29



black / pearl deep red - matt / glossy

SUPER FIT
by GHOST



E-TERU PRO

E-TERU AL

Rock Shox 35 Silver TK Solo Air 120 mm

Ground Fiftyone Dia. 31.8 mm

Ground Fiftyone Dia. 31.8 mm 720/20 (XS/S) 740/27 (M-XL)

Shimano XT RD-M8100 12-S

Shimano SLX SL-M7100

Miranda Virage 38T

Shimano SLX CS-M7100 10-51

Shimano BR-MT420 203 mm Disc

Ghost 34.9 mm

Selle Royal Vivo

Feimin H856 + Acros Blocklock

SRAM UDH

MTB Grip

Schwalbe Smart Sam 2.35 (XS-S 27,5"; M-XL 29") //
Schwalbe Smart Sam 2.35 (XS-S 27,5"; M-XL 29")

Schürmann Yak Disc 25 //
Schürmann Yak Disc 25

Shimano HB-MT400-B 15x110 mm

Shimano FH-MT510-B 12x148 mm

Bosch Kiox 300

Bosch Performance Line CX

Bosch Power Tube 750 Wh

Bosch Charger 4 Ah

GRÖSSE	ARTIKELNUMMER	LAUFRADGRÖSSE
XS	31ET1070	27.5
S	31ET1071	27.5
M	31ET1072	29
L	31ET1073	29
XL	31ET1074	29



black / pearl deep red - matt / glossy



E-TERU PRO EQ

E-TERU AL	Ghost 34.9 mm	Bosch Kiox 300
Rock Shox 35 Silver TK Solo Air 100 mm	Selle Royal Vivo	Bosch Performance Line CX
Ground Fiftyone Adjustable Dia. 31.8 mm	Feimin FP-H858U + Acros Blocklock	Bosch Power Tube 750 Wh
Ground Fiftyone Dia. 31.8 mm 720/20 (XS/S) 740/27 (M-XL)	SRAM UDH	Bosch Charger 4 Ah
Shimano XT RD-M8100 12-S	MTB Grip	Carrier
Shimano SLX SL-M7100	Schwalbe Johnny Watts 2.35 // Schwalbe Johnny Watts 2.35	Fender
Miranda Virage 38T	Schürmann Yak Disc 25 // Schürmann Yak Disc 25	Ursus Mooi
Shimano SLX CS-M7100 10-51	Shimano HB-MT400-B 15x110 mm	Herrmans H-Black MR8
Shimano BR-MT420 203 mm Disc	Shimano FH-MT510-B 12x148 mm	Axa Juno E-Bike

GRÖSSE	ARTIKELNUMMER	LAUFRADGRÖSSE
XS	31ET1077	27.5
S	31ET1078	27.5
M	31ET1079	27.5
L	31ET1080	27.5
XL	31ET1081	27.5



black / pearl deep red - matt / glossy

SUPER FIT
by GHOST



E-TERU PRO EQ LOW

E-TERU AL Low

Rock Shox 35 Silver TK Solo Air 100 mm

Ground Fiftyone Adjustable Dia. 31.8 mm

Ground Fiftyone Dia. 31.8 mm 720/20 (S) 740/27 (M-L)

Shimano XT RD-M8100 12-S

Shimano SLX SL-M7100

Miranda Virage 38T

Shimano SLX CS-M7100 10-51

Shimano BR-MT420 203 mm Disc

Ghost 34.9 mm

Selle Royal Vivo

Cane Creek Visco Set + Acros Blocklock

SRAM UDH

MTB Grip

Schwalbe Johnny Watts 2.35 //
Schwalbe Johnny Watts 2.35

Schürmann Yak Disc 25 //
Schürmann Yak Disc 25

Shimano HB-MT400-B 15x110 mm

Shimano FH-MT510-B 12x148 mm

Bosch Kiox 300

Bosch Performance Line CX

Bosch Power Tube 750 Wh

Bosch Charger 4 Ah

Carrier

Fender

Ursus Mooi

Herrmans H-Black MR8

Axa Juno E-Bike

GRÖSSE	ARTIKELNUMMER	LAUFRADGRÖSSE
S	31ET1084	27.5
M	31ET1085	27.5
L	31ET1086	27.5



black / dark grey - matt / glossy

SUPER FIT
by GHOST



E-TERU ADVANCED

E-TERU AL

SR Suntour XCR34 Air Boost LOR DS 120 mm

Ground Fiftyone Dia. 31.8 mm

Ground Fiftyone Dia. 31.8 mm 720/20 (S) 740/27 (M-XL)

Shimano XT Linkglide RD-M8130 11-S

Shimano XT Linkglide SL-M8130

Miranda Virage 38T

Shimano XT Linkglide CS-LG600-11 11-50

Shimano BR-MT420 203 mm Disc

Ghost 34.9 mm

Selle Royal Vivo

Feimin H856 + Acros Blocklock

SRAM UDH

MTB Grip

Schwalbe Smart Sam 2.35 (S 27,5"; M-XL 29") //
Schwalbe Smart Sam 2.35 (S 27,5"; M-XL 29")

Schürmann Yak Disc 25 //
Schürmann Yak Disc 25

Shimano HB-MT400-B 15x110 mm

Shimano FH-MT400-B 12x148 mm

Bosch Kiox 300

Bosch Performance Line CX

Bosch Power Tube 750 Wh

Bosch Charger 4 Ah

GRÖSSE	ARTIKELNUMMER	LAUFRADGRÖSSE
S	31ET1037	27.5
M	31ET1038	29
L	31ET1039	29
XL	31ET1040	29



met. anthracite / met. gold yellow - glossy

SUPER FIT
by GHOST



E-TERU ADVANCED

E-TERU AL

SR Suntour XCR34 Air Boost LOR DS 120 mm

Ground Fiftyone Dia. 31.8 mm

Ground Fiftyone Dia. 31.8 mm 720/20 (S) 740/27 (M-XL)

Shimano XT Linkglide RD-M8130 11-S

Shimano XT Linkglide SL-M8130

Miranda Virage 38T

Shimano XT Linkglide CS-LG600-11 11-50

Shimano BR-MT420 203 mm Disc

Ghost 34.9 mm

Selle Royal Vivo

Feimin H856 + Acros Blocklock

SRAM UDH

MTB Grip

Schwalbe Smart Sam 2.35 (S 27,5"; M-XL 29") //
Schwalbe Smart Sam 2.35 (S 27,5"; M-XL 29")

Schürmann Yak Disc 25 //
Schürmann Yak Disc 25

Shimano HB-MT400-B 15x110 mm

Shimano FH-MT400-B 12x148 mm

Bosch Kiox 300

Bosch Performance Line CX

Bosch Power Tube 750 Wh

Bosch Charger 4 Ah

GRÖSSE	ARTIKELNUMMER	LAUFRADGRÖSSE
S	31ET1044	27.5
M	31ET1045	29
L	31ET1046	29
XL	31ET1047	29



black / dark grey - matt / glossy



SUPER FIT
by GHOST



E-TERU ADVANCED EQ

E-TERU AL

SR Suntour XCR34 Air Boost LOR DS 100 mm

Ground Fiftyone Adjustable Dia. 31.8 mm

Ground Fiftyone Dia. 31.8 mm 720/20 (S) 740/27 (M-XXL)

Shimano XT Linkglide RD-M8130 11-S

Shimano XT Linkglide SL-M8130

Miranda Virage 38T

Shimano XT Linkglide CS-LG600-11 11-50

Shimano BR-MT420 203 mm Disc

Ghost 34.9 mm

Selle Royal Vivo

Feimin FP-H858U + Acros Blocklock

SRAM UDH

MTB Grip

Schwalbe Johnny Watts 2.35 //
Schwalbe Johnny Watts 2.35

Schürmann Yak Disc 25 //
Schürmann Yak Disc 25

Shimano HB-MT400-B 15x110 mm

Shimano FH-MT400-B 12x148 mm

Bosch Kiox 300

Bosch Performance Line CX

Bosch Power Tube 750 Wh

Bosch Charger 4 Ah

Carrier

Fender

Ursus Mooi

Herrmans H-Black MR4

Axa Juno E-Bike

GRÖSSE ARTIKELNUMMER LAUFRADGRÖSSE

S	31ET1051	27.5
M	31ET1052	27.5
L	31ET1053	27.5
XL	31ET1054	27.5
XXL	31ET1055	27.5



black / dark grey - matt / glossy

SUPER FIT
by GHOST



E-TERU ADVANCED EQ LOW

E-TERU AL Low

SR Suntour XCR34 Air Boost LOR DS 100 mm

Ground Fiftyone Adjustable Dia. 31.8 mm

Ground Fiftyone Dia. 31.8 mm 720/20 (S) 740/27 (M-L)

Shimano XT Linkglide RD-M8130 11-S

Shimano XT Linkglide SL-M8130

Miranda Virage 38T

Shimano XT Linkglide CS-LG600-11 11-50

Shimano BR-MT420 203 mm Disc

Ghost 34.9 mm

Selle Royal Vivo

Cane Creek Visco Set + Acros Blocklock

SRAM UDH

MTB Grip

Schwalbe Johnny Watts 2.35 //
Schwalbe Johnny Watts 2.35

Schürmann Yak Disc 25 //
Schürmann Yak Disc 25

Shimano HB-MT400-B 15x110 mm

Shimano FH-MT400-B 12x148 mm

Bosch Kiox 300

Bosch Performance Line CX

Bosch Power Tube 750 Wh

Bosch Charger 4 Ah

Carrier

Fender

Ursus Mooi

Herrmans H-Black MR4

Axa Juno E-Bike

GRÖSSE	ARTIKELNUMMER	LAUFRADGRÖSSE
S	31ET1058	
M	31ET1059	
L	31ET1060	



black/metallic rust red - glossy

SUPER FIT
by GHOST



E-TERU UNIVERSAL

E-TERU AL

SR Suntour XCM34 Boost DS 120 mm

Ground Fiftyone Dia. 31.8 mm

Ground Fiftyone Dia. 31.8 mm 720/20 (XS/S) 740/27 (M-XL)

Shimano CUES RD-U6000 10-S

Shimano CUES SL-U6000-10

Miranda Virage 38T

Shimano CUES CS-LG300-10 11-48

Shimano BR-MT420 180 mm

Ghost 34.9 mm

Selle Royal Vivo

Feimin H856 + Acros Blocklock

SRAM UDH

MTB Grip

Schwalbe Smart Sam 2.35 //
Schwalbe Smart Sam 2.35

Schürmann Yak Disc 25 //
Schürmann Yak Disc 25

Shimano HB-TC500-15-B 15x110 mm

Shimano FH-TC500-HM-B 12x148 mm

Bosch LED Remote

Bosch Performance Line CX

Bosch Power Tube 625 Wh

Bosch Charger 4 Ah

GRÖSSE	ARTIKELNUMMER	LAUFRADGRÖSSE
XS	24ET1001	27.5
S	24ET1002	27.5
M	24ET1003	29
L	24ET1004	29
XL	24ET1005	29



pearl warm grey / pearl dark blue - matt

SUPER FIT
by GHOST



E-TERU UNIVERSAL

E-TERU AL

SR Suntour XCM34 Boost DS 120 mm

Ground Fiftyone Dia. 31.8 mm

Ground Fiftyone Dia. 31.8 mm 720/20 (XS/S) 740/27 (M-XL)

Shimano CUES RD-U6000 10-S

Shimano CUES SL-U6000-10

Miranda Virage 38T

Shimano CUES CS-LG300-10 11-48

Shimano BR-MT420 180 mm

Ghost 34.9 mm

Selle Royal Vivo

Feimin H856 + Acros Blocklock

SRAM UDH

MTB Grip

Schwalbe Smart Sam 2.35 //
Schwalbe Smart Sam 2.35

Schürmann Yak Disc 25 //
Schürmann Yak Disc 25

Shimano HB-TC500-15 B 15x110 mm

Shimano FH-TC500-HM-B 12x148 mm

Bosch LED Remote

Bosch Performance Line CX

Bosch Power Tube 625 Wh

Bosch Charger 4 Ah

GRÖSSE	ARTIKELNUMMER	LAUFRADGRÖSSE
XS	31ET1018	27.5
S	31ET1019	27.5
M	31ET1020	29
L	31ET1021	29
XL	31ET1022	29



black/metallic rust red - glossy

SUPER FIT
by GHOST



E-TERU UNIVERSAL EQ

E-Teru AL

SR Suntour XCM34 Boost DS 100 mm

Ground Fiftyone Adjustable Dia. 31.8 mm

Ground Fiftyone Dia. 31.8 mm 720/20 (XS/S) 740/27 (M-XL)

Shimano CUES RD-U6000 10-S

Shimano CUES SL-U6000-10

Miranda Virage 38T

Shimano CUES CS-LG300-10 11-48

Shimano BR-MT420 180 mm

Ghost 34.9 mm

Selle Royal Vivo

Feimin FP-H858U + Acros Blocklock

SRAM UDH

MTB Grip

Schwalbe Johnny Watts 2.35 //
Schwalbe Johnny Watts 2.35

Schürmann Yak Disc 25 //
Schürmann Yak Disc 25

Shimano HB-TC500-15-B 15x110 mm

Shimano FH-TC500-HM-B 12x148 mm

Bosch Kiox 300

Bosch Performance Line CX

Bosch Power Tube 625 Wh

Bosch Charger 4 Ah

Carrier

Fender

Ursus Mooi

Herrmans H-Black MR4 E

Axa Juno E-Bike

GRÖSSE	ARTIKELNUMMER	LAUFRADGRÖSSE
XS	24ET1014	
S	24ET1015	
M	24ET1016	
L	24ET1017	
XL	24ET1018	



pearl warm grey / pearl dark blue - matt

SUPER FIT
by GHOST



E-TERU UNIVERSAL EQ

E-Teru AL

SR Suntour XCM34 Boost DS 100 mm

Ground Fiftyone Adjustable Dia. 31.8 mm

Ground Fiftyone Dia. 31.8 mm 720/20 (XS/S) 740/27 (M-XL)

Shimano CUES RD-U6000 10-S

Shimano CUES SL-U6000-10

Miranda Virage 38T

Shimano CUES CS-LG300-10 11-48

Shimano BR-MT420 180 mm

Ghost 34.9 mm

Selle Royal Vivo

Feimin FP-H858U + Acros Blocklock

SRAM UDH

MTB Grip

Schwalbe Johnny Watts 2.35 //
Schwalbe Johnny Watts 2.35

Schürmann Yak Disc 25 //
Schürmann Yak Disc 25

Shimano HB-TC500-15 B 15x110 mm

Shimano FH-TC500-HM-B 12x148 mm

Bosch Kiox 300

Bosch Performance Line CX

Bosch Power Tube 625 Wh

Bosch Charger 4 Ah

Carrier

Fender

Ursus Mooi

Herrmans H-Black MR4 E

Axa Juno E-Bike

GRÖSSE ARTIKELNUMMER LAUFRADGRÖSSE

XS	31ET1025	27.5
S	31ET1026	27.5
M	31ET1027	27.5
L	31ET1028	27.5
XL	31ET1029	27.5



black/metallic rust red - glossy

SUPER FIT
by GHOST



E-TERU UNIVERSAL EQ LOW

E-Teru AL

SR Suntour XCM34 Boost DS 100 mm

Ground Fiftyone Adjustable Dia. 31.8 mm

Ground Fiftyone Dia. 31.8 mm 720/20 (S) 740/27 (M-L)

Shimano CUES RD-U6000 10-S

Shimano CUES SL-U6000-10

Miranda Virage 38T

Shimano CUES CS-LG300-10 11-48

Shimano BR-MT420 180 mm

Ghost 34.9 mm

Selle Royal Vivo

Cane Creek Visco Set + Acros Blocklock

SRAM UDH

MTB Grip

Schwalbe Johnny Watts 2.35 //
Schwalbe Johnny Watts 2.35

Schürmann Yak Disc 25 //
Schürmann Yak Disc 25

Shimano HB-TC500-15-B 15x110 mm

Shimano FH-TC500-HM-B 12x148 mm

Bosch Kiox 300

Bosch Performance Line CX

Bosch Power Tube 625 Wh

Bosch Charger 4 Ah

Carrier

Fender

Ursus Mooi

Herrmans H-Black MR4 E

Axa Juno E-Bike

GRÖSSE	ARTIKELNUMMER	LAUFRADGRÖSSE
S	24ET1021	
M	24ET1022	
L	24ET1023	



pearl warm grey / pearl dark blue - matt

SUPER FIT
by GHOST



E-TERU UNIVERSAL EQ LOW

E-Teru AL

SR Suntour XCM34 Boost DS 100 mm

Ground Fiftyone Adjustable Dia. 31.8 mm

Ground Fiftyone Dia. 31.8 mm 720/20 (S) 740/27 (M-L)

Shimano CUES RD-U6000 10-S

Shimano CUES SL-U6000-10

Miranda Virage 38T

Shimano CUES CS-LG300-10 11-48

Shimano BR-MT420 180 mm

Ghost 34.9 mm

Selle Royal Vivo

Cane Creek Visco Set + Acros Blocklock

SRAM UDH

MTB Grip

Schwalbe Johnny Watts 2.35 //
Schwalbe Johnny Watts 2.35

Schürmann Yak Disc 25 //
Schürmann Yak Disc 25

Shimano HB-TC500-15 B 15x110 mm

Shimano FH-TC500-HM-B 12x148 mm

Bosch Kiox 300

Bosch Performance Line CX

Bosch Power Tube 625 Wh

Bosch Charger 4 Ah

Carrier

Fender

Ursus Mooi

Herrmans H-Black MR4 E

Axa Juno E-Bike

GRÖSSE	ARTIKELNUMMER	LAUFRADGRÖSSE
S	31ET1032	27.5
M	31ET1033	27.5
L	31ET1034	27.5



dark grey / met. light blue - matt



E-TERU ESSENTIAL

E-TERU AL	Shimano CUES CS-LG400-9 11-41	Schürmann Yak Disc 25 // Schürmann Yak Disc 25
SR Suntour XCM32 Boost DS 120 mm	Tektro HD-M275 180 mm Disc	Shimano HB-TC500-15 B 15x110 mm
Ground Fiftyone Dia. 31.8 mm	Ghost 31.6 mm	Shimano FH-TC500-HM-B 12x148 mm
Ground Fiftyone Dia. 31.8 mm 700/0 (S) 720/20 (M) 740/27 (L) 760/40 (XL)	Selle Royal Vivo	Bosch LED Remote
Shimano CUES RD-U4000 9-S	Feimin FP-868P	Bosch Performance Line
Shimano CUES SL-U4010	MTB Grip	Bosch Power Tube 500 Wh
Miranda Virage 38T	Schwalbe Smart Sam 2.35 (S 27,5"; M-XL 29") // Schwalbe Smart Sam 2.35 (S 27,5"; M-XL 29")	Bosch Charger 2 Ah

GRÖSSE	ARTIKELNUMMER	LAUFRADGRÖSSE
S	31ET1001	27,5
M	31ET1002	29
L	31ET1003	29
XL	31ET1004	29





riot red/metallic anthrazit - glossy



SUPER FIT
by GHOST



E-TERU ESSENTIAL EQ

E-TERU AL

SR Suntour XCM32 Boost DS 80 mm

Ground Fiftyone Dia. 31.8 mm

Ground Fiftyone Dia. 31.8 mm 700/0 (S) 720/20 (M) 740/27 (L/XL)

Shimano CUES RD-U4000 9-S

Shimano CUES SL-U4010

Miranda Virage 38T

Shimano CUES CS-LG400-9 11-41

Tektro HD-M275 180 mm

Ghost 31.6 mm

Selle Royal Vivo

Feimin FP-868P

MTB Grip

Schwalbe Johnny Watts 2.35 //
Schwalbe Johnny Watts 2.35

Schürmann Yak Disc 25 //
Schürmann Yak Disc 25

Shimano HB-TC500-15 B 15x110 mm

Shimano FH-TC500-HM-B 12x148 mm

Bosch LED Remote

Bosch Performance Line

Bosch Power Tube 500 Wh

Bosch Charger 2 Ah

Carrier

Eurofender 65 mm

Ursus Mooi

Trelock LS230

Axa Juno E-Bike

GRÖSSE	ARTIKELNUMMER	LAUFRADGRÖSSE
S	24ET1008	
M	24ET1009	
L	24ET1010	
XL	24ET1011	



dark grey / met. light blue - matt

SUPER FIT
by GHOST



E-TERU ESSENTIAL EQ

E-TERU AL

SR Suntour XCM32 Boost DS 80 mm

Ground Fiftyone Dia. 31.8 mm

Ground Fiftyone Dia. 31.8 mm 700/0 (S) 720/20 (M) 740/27 (L) 760/40 (XL)

Shimano CUES RD-U4000 9-S

Shimano CUES SL-U4010

Miranda Virage 38T

Shimano CUES CS-LG400-9 11-41

Tektro HD-M275 180 mm Disc

Ghost 31.6 mm

Selle Royal Vivo

Feimin FP-868P

MTB Grip

Schwalbe Johnny Watts 2.35 //
Schwalbe Johnny Watts 2.35

Schürmann Yak Disc 25 //
Schürmann Yak Disc 25

Shimano HB-TC500-15 B 15x110 mm

Shimano FH-TC500-HM-B 12x148 mm

Bosch LED Remote

Bosch Performance Line

Bosch Power Tube 500 Wh

Bosch Charger 2 Ah

Carrier

Eurofender 65 mm

Ursus Mooi

Trelock LS230

Axa Juno E-Bike

GRÖSSE	ARTIKELNUMMER	LAUFRADGRÖSSE
S	31ET1007	27.5
M	31ET1008	27.5
L	31ET1009	27.5
XL	31ET1010	27.5



dark grey / met. light blue - matt

SUPER FIT
by GHOST



E-TERU ESSENTIAL EQ MID

E-TERU AL Mid

SR Suntour XCM32 Boost DS 80 mm

Ground Fiftyone Dia. 31.8 mm

Ground Fiftyone Dia. 31.8 mm 700/0 (S) 720/20 (M) 740/27 (L)

Shimano CUES RD-U4000 9-S

Shimano CUES SL-U4010

Miranda Virage 38T

Shimano CUES CS-LG400-9 11-41

Tektro HD-M275 180 mm Disc

Ghost 31.6 mm

Selle Royal Vivo

Feimin FP-868P

MTB Grip

Schwalbe Johnny Watts 2.35 //
Schwalbe Johnny Watts 2.35

Schürmann Yak Disc 25 //
Schürmann Yak Disc 25

Shimano HB-TC500-15 B 15x110 mm

Shimano FH-TC500-HM-B 12x148 mm

Bosch LED Remote

Bosch Performance Line

Bosch Power Tube 500 Wh

Bosch Charger 2 Ah

Carrier

Eurofender 65 mm

Ursus Mooi

Trelock LS230

Axa Juno E-Bike

GRÖSSE	ARTIKELNUMMER	LAUFRADGRÖSSE
S	31ET1013	27.5
M	31ET1014	27.5
L	31ET1015	27.5



dark grey / met. light blue - matt

SUPER FIT
by GHOST



E-TERU

E-TERU AL Mid	Shimano CUES CS-LG400-9 11-41	Schürmann Yak Disc 25 // Schürmann Yak Disc 25
SR Suntour XCM32 Boost DS 120 mm	Tektro HD-M275 180 mm Disc	Shimano HB-TC500-15 B 15x110 mm
Ground Fiftyone Dia. 31.8 mm	Ghost 31.6 mm	Shimano FH-TC500-HM-B 12x148 mm
Ground Fiftyone Dia. 31.8 mm 700/0	Selle Royal Vivo	Bosch LED Remote
Shimano CUES RD-U4000 9-S	Feimin FP-868P	Bosch Performance Line
Shimano CUES SL-U4010	MTB Grip	Bosch Power Tube 500 Wh
Miranda Virage 38T	Schwalbe Smart Sam 2.35 // Schwalbe Smart Sam 2.35	Bosch Charger 2 Ah

GRÖSSE ARTIKELNUMMER LAUFRADGRÖSSE

XS

31ET1089

27.5







BIKES

ASKET

RIOT

LECTOR

NIRVANA

KATO

LANAO

YOUTH

KIDS

SQUARE

rawcarbon/silver - glossy



ASKET CF „30“

ASKET CF

Rock Shox Rudy Ultimate XPLR 40 mm

Ghost Dia. 31.8 mm

Easton EC70 AX 420 mm (XS/S) 440 mm (M) 460 mm (L/XL)

SRAM X0 Eagle Transmission 12-S

SRAM Force AXS

SRAM Force 1 Wide 40T

SRAM CS XS 1295 T-Type 10-52

SRAM Force AXS 160 mm

DT Swiss G1800 Spline 12x100 //
DT Swiss G1800 Spline 12x142

Rock Shox Reverb AXS XPLR 27.2 mm 50 mm (XS-M) 75 mm (L/XL)

Prologo Dimension AGX

Acros

SRAM PF DUB

Prologo Microtouch

Maxxis Rambler Silk Shield 45-622 //
Maxxis Rambler Silk Shield 45-622

GRÖSSE	ARTIKELNUMMER	LAUFRADGRÖSSE
XS	24AK1029	28
S	24AK1030	28
M	24AK1031	28
L	24AK1032	28
XL	24AK1033	28



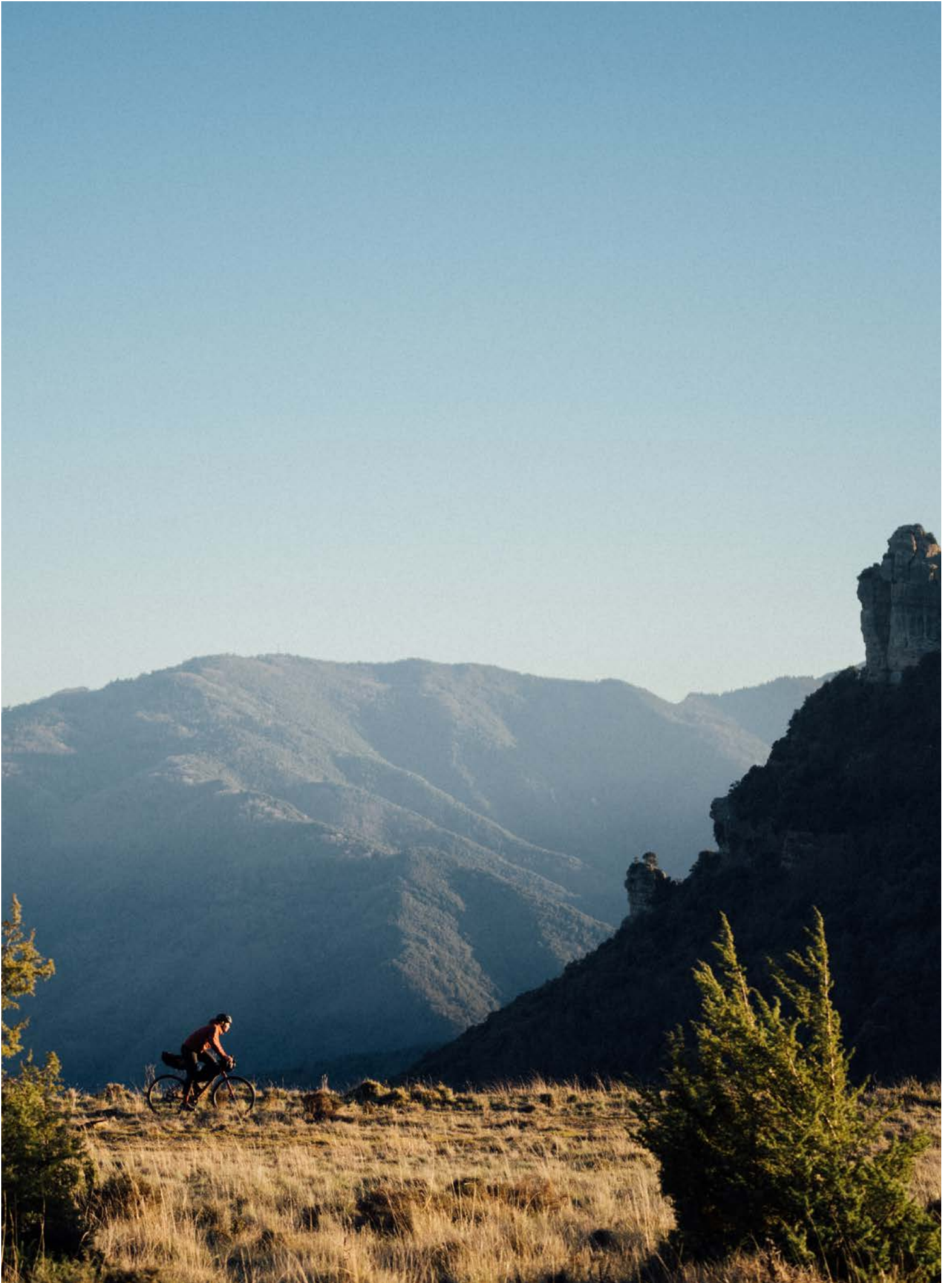

metallic dark blue/carbon showing - glossy



ASKET CF FULL PARTY

ASKET CF

Fox 32 Float Taper Cast Performance Elite FIT4 40 mm

Ghost Dia. 31.8 mm

Gravel Bar 420 mm (XS) 440 mm (S) 460 mm (M) 480 mm (L) 500 mm (XL)

Shimano GRX RD-RX822 12-S

Shimano GRX ST-RX820

Shimano GRX FC-RX820 40T

Shimano SLX CS-M7100 10-51

Shimano BR-RX820 160 mm

GND 51 27.2 mm

Prologo Dimension AGX

Acros

Shimano SM-BB72-41B

Prologo Microtouch

Maxxis Rambler Silk Shield 45-622 //
Maxxis Rambler Silk Shield 45-622

Rodi Ready 23 Asy //
Rodi Ready 23 Asy

Shimano HB-RS470 12x100 mm

Shimano FH-TC500-MS 12x142 mm

GRÖSSE	ARTIKELNUMMER	LAUFRADGRÖSSE
XS	24AK1022	28
S	24AK1023	28
M	24AK1024	28
L	24AK1025	28
XL	24AK1026	28



pearl light green/black - matt



ASKET CF PRO

- ASKET CF
- GHOST Carbon
- Ghost Dia. 31.8 mm
- Gravel Bar 420 mm (XS) 440 mm (S) 460 mm (M) 480 mm (L) 500 mm (XL)
- Shimano GRX RD-RX822 12-S
- Shimano GRX ST-RX610

- Shimano GRX FC-RX610 40T
- Shimano SLX CS-M7100 10-51
- Shimano BR-RX410 160 mm
- GND 51 27.2 mm
- Prologo Dimension AGX
- Acros

- Shimano SM-BB72-41B
- Prologo Microtouch
- Maxxis Rambler Silk Shield 45-622 // Maxxis Rambler Silk Shield 45-622
- Rodi Ready 23 Asy // Rodi Ready 23 Asy
- Shimano HB-RS470 12x100 mm
- Shimano FH-TC500-MS 12x142 mm

GRÖSSE	ARTIKELNUMMER	LAUFRADGRÖSSE
XS	24AK1015	28
S	24AK1016	28
M	24AK1017	28
L	24AK1018	28
XL	24AK1019	28



light grey/met. anthrazit - glossy

SUPER FIT
by **GHOST**



ASKET ADVANCED

ASKET AL

GHOST Carbon

Ghost Dia. 31.8 mm

Gravel Bar RA120A 420 mm (XS) 440 mm (S) 460 mm (M) 480 mm (L) 500 mm (XL)

Shimano GRX RD-RX812 11-S

Shimano GRX ST-RX600

Shimano GRX FC-RX810 40T

Shimano XT CS-M8000 11-42

Shimano BR-RX400 160 mm

GND 51 27.2 mm

Selle Royal SRX

Acros

Shimano SM-BBR60

Fizik Tempo Bondcrush

Maxxis Ravager Exo TR 40-622 //
Maxxis Ravager Exo TR 40-622

Rodi Ready 23 Asy //
Rodi Ready 23 Asy

Shimano HB-RS470 12x100 mm

Shimano FH-TC500-HM 12x142 mm

GRÖSSE	ARTIKELNUMMER	LAUFRADGRÖSSE
XS	24AK1008	28
S	24AK1009	28
M	24AK1010	28
L	24AK1011	28
XL	24AK1012	28



met. rusted dark red / black - matt



SUPER FIT
by GHOST



ASKET ADVANCED

 ASKET AL

 GHOST Carbon

 Ghost Dia. 31.8 mm

 Gravel Bar RA120A 420 mm (XS) 440 mm (S) 460 mm (M) 480 mm (L) 500 mm (XL)

 Shimano GRX RD-RX812 11-S

 Shimano GRX ST-RX600

 Shimano GRX FC-RX810 40T

 Shimano XT CS-M8000 11-42

 Shimano GRX BR-RX400 160 mm Disc

 GND 51 27.2 mm

 Selle Royal SRX

 Acros

 Shimano SM-BBR60

 FRHG0065

 Fizik Tempo Bondcrush

 Maxxis Ravager Exo TR 40-622 //
Maxxis Ravager Exo TR 40-622

 WTB ST i25 //
WTB ST i25

 Shimano HB-R7070 12x100 mm

 Shimano FH-R7070 12x142 mm

GRÖSSE	ARTIKELNUMMER	LAUFRADGRÖSSE
XS	31AK1041	28
S	31AK1042	28
M	31AK1043	28
L	31AK1044	28
XL	31AK1045	28





met. rusted dark red / black - matt



SUPER FIT
by GHOST



ASKET ADVANCED EQ

ASKET AL	Shimano GRX BR-RX400 160 mm Disc	WTB ST i25 // WTB ST i25
GHOST Carbon	GND 51 27.2 mm	Shimano HB-RS470 12x100 mm
Ghost Dia. 31.8 mm	Selle Royal SRX	Shimano FH-MT400 12x142 mm
Gravel Bar RA120A 420 mm (XS) 440 mm (S) 460 mm (M) 480 mm (L) 500 mm (XL)	Acros	Acepac, bar harness Black
Shimano GRX RD-RX812 11-S	Shimano SM-BBR60	Acepac, bar drybag 8L Black
Shimano GRX ST-RX600	FRHG0065	Acepac, saddle harness Black
Shimano GRX FC-RX810 40T	Fizik Tempo Bondcrush	Acepac, saddle drybag 16L Black
Shimano XT CS-M8000 11-42	Maxxis Ravager Exo TR 40-622 // Maxxis Ravager Exo TR 40-622	Acepac, zip frame bag L Black (for frame size: M, L, XL) Acepac Fuel Bag L (for frame size: XS, S)

GRÖSSE	ARTIKELNUMMER	LAUFRADGRÖSSE
XS	31AK1048	28
S	31AK1049	28
M	31AK1050	28
L	31AK1051	28
XL	31AK1052	28



met. dark blue / pearl blue green - matt



ASKET ESSENTIAL

- ASKET AL

- GHOST Carbon

- Ghost Dia. 31.8 mm

- Gravel Bar RA120A 420 mm (XS) 440 mm (S) 460 mm (M) 480 mm (L) 500 mm (XL)

- Shimano GRX RD-RX400 10-S

- Shimano GRX FD-RX400

- Shimano GRX ST-RX400

- Shimano GRX FC-RX600 46-30T

- Shimano CS-HG50-10 11-36

- Shimano GRX BR-RX400 160 mm Disc

- GND 51 27.2 mm

- Selle Royal SRX

- Acros

- Shimano BSA

- FRHG0065

- Fizik Tempo Bondcrush

- Maxxis Ravager Exo TR 40-622 // Maxxis Ravager Exo TR 40-622

- WTB ST i25 // WTB ST i25

- Shimano HB-RS470 12x100 mm

- Shimano FH-MT400 12x142 mm

GRÖSSE	ARTIKELNUMMER	LAUFRADGRÖSSE
XS	31AK1028	28
S	31AK1029	28
M	31AK1030	28
L	31AK1031	28
XL	31AK1032	28



black / light kaki - matt

SUPER FIT
by GHOST



ASKET ESSENTIAL

ASKET AL

GHOST Carbon

Ghost Dia. 31.8 mm

Gravel Bar RA120A 420 mm (XS) 440 mm (S) 460 mm (M) 480 mm (L) 500 mm (XL)

Shimano GRX RD-RX400 10-S

Shimano GRX FD-RX400

Shimano GRX ST-RX400

Shimano GRX FC-RX600 46-30T

Shimano CS-HG50-10 11-36

Shimano GRX BR-RX400 160 mm Disc

GND 51 27.2 mm

Selle Royal SRX

Acros

Shimano BSA

FRHG0065

Fizik Tempo Bondcrush

Maxxis Ravager Exo TR 40-622 //
Maxxis Ravager Exo TR 40-622

WTB ST i25 //
WTB ST i25

Shimano HB-RS470 12x100 mm

Shimano FH-MT400 12x142 mm

GRÖSSE	ARTIKELNUMMER	LAUFRADGRÖSSE
XS	31AK1021	28
S	31AK1022	28
M	31AK1023	28
L	31AK1024	28
XL	31AK1025	28



black / light kaki - matt

SUPER FIT
by GHOST



ASKET ESSENTIAL EQ

ASKET AL

GHOST Carbon

Ghost Dia. 31.8 mm

Gravel Bar RA120A 420 mm (XS) 440 mm (S) 460 mm (M) 480 mm (L) 500 mm (XL)

Shimano GRX RD-RX400 10-S

Shimano GRX FD-RX400

Shimano GRX ST-RX400

Shimano GRX FC-RX600 46-30T

Shimano CS-HG50-10 11-36

Shimano GRX BR-RX400 160 mm Disc

GND 51 27.2 mm

Selle Royal SRX

Acros

Shimano BSA

FRHG0065

Fizik Tempo Bondcrush

Maxxis Ravager Exo TR 40-622 //
Maxxis Ravager Exo TR 40-622

WTB ST i25 //
WTB ST i25

Shimano HB-RS470 12x100 mm

Shimano FH-MT400 12x142 mm

Racktime Light IT 2.0

Curana Apollo 55

Lezyne Hecto Pro 65

Lezyne Hecto Pro 65

GRÖSSE	ARTIKELNUMMER	LAUFRADGRÖSSE
XS	31AK1034	28
S	31AK1035	28
M	31AK1036	28
L	31AK1037	28
XL	31AK1038	28







brown/metallic light beige - matt



SUPER FIT
by GHOST



ASKET

ASKET AL

GHOST Carbon

Ghost Dia. 31.8 mm

Gravel Bar RA120A 420 mm (XS) 440 mm (S) 460 mm (M) 480 mm (L) 500 mm (XL)

Shimano Sora RD-M3000 9-S

Shimano Sora FD-R3030

Shimano Sora ST-R3000

FSA CK-201 46-30

Shimano CS-HG400-9 11-34

Shimano BR-RS305 160 mm

GND 51 27.2 mm

Selle Royal SRX

Acros

Feimin FP-B908N

Fizik Tempo Bondcrush

Maxxis Ravager Exo TR 40-622 //
Maxxis Ravager Exo TR 40-622

Rodi Ready 23 Asy //
Rodi Ready 23 Asy

Shimano HB-RS470 12x100 mm

Shimano FH-TC500-HM 12x142 mm

GRÖSSE	ARTIKELNUMMER	LAUFRADGRÖSSE
XS	24AK1001	28
S	24AK1002	28
M	24AK1003	28
L	24AK1004	28
XL	24AK1005	28



dark grey / shark blue - matt



ASKET

ASKET AL
GHOST Carbon
Ghost Dia. 31.8 mm
Gravel Bar RA120A 420 mm (XS) 440 mm (S) 460 mm (M) 480 mm (L) 500 mm (XL)
Shimano Sora RD-R3000 9-S
Shimano Sora FD-R3030
Shimano Sora ST-R3000

FSA CK-C201ST 46-30T
Shimano CS-HG400-9 11-34
Shimano BR-RS305 160 mm Disc
GND 51 27.2 mm
Selle Royal SRX
Acros
Feimin FP-B908N

FRHG0065
Fizik Tempo Bondcrush
Maxxis Ravager Exo TR 40-622 // Maxxis Ravager Exo TR 40-622
WTB ST i25 // WTB ST i25
Shimano HB-RS470 12x100 mm
Shimano FH-MT400 12x142 mm

GRÖSSE	ARTIKELNUMMER	LAUFRADGRÖSSE
XS	31AK1001	28
S	31AK1002	28
M	31AK1003	28
L	31AK1004	28
XL	31AK1005	28



dark grey / shark blue - matt

SUPER FIT
by GHOST



ASKET EQ

ASKET AL

GHOST Carbon

Ghost Dia. 31.8 mm

Gravel Bar RA120A 420 mm (XS) 440 mm (S) 460 mm (M) 480 mm (L) 500 mm (XL)

Shimano Sora RD-R3000 9-S

Shimano Sora FD-R3030

Shimano Sora ST-R3000

FSA CK-C201ST 46-30T

Shimano CS-HG400-9 11-34

Shimano BR-RS305 160 mm Disc

GND 51 27.2 mm

Selle Royal SRX

Acros

Feimin FP-B908N

FRHG0065

Fizik Tempo Bondcrush

Maxxis Ravager Exo TR 40-622 //
Maxxis Ravager Exo TR 40-622

WTB ST i25 //
WTB ST i25

Shimano HB-RS470 12x100 mm

Shimano FH-MT400 12x142 mm

Racktime Light IT 2.0

Curana Apollo 55

Lezyne Hecto Pro 65

Lezyne Hecto Pro 65

GRÖSSE	ARTIKELNUMMER	LAUFRADGRÖSSE
XS	31AK1008	28
S	31AK1009	28
M	31AK1010	28
L	31AK1011	28
XL	31AK1012	28



very dark purple / light grey - matt

SUPER FIT
by GHOST



ASKET EQ

ASKET AL

GHOST Carbon

Ghost Dia. 31.8 mm

Gravel Bar RA120A 420 mm (XS) 440 mm (S) 460 mm (M) 480 mm (L) 500 mm (XL)

Shimano Sora RD-R3000 9-S

Shimano Sora FD-R3030

Shimano Sora ST-R3000

FSA CK-C201ST 46-30T

Shimano CS-HG400-9 11-34

Shimano BR-RS305 160 mm Disc

GND 51 27.2 mm

Selle Royal SRX

Acros

Feimin FP-B908N

FRHG0065

Fizik Tempo Bondcrush

Maxxis Ravager Exo TR 40-622 //
Maxxis Ravager Exo TR 40-622

WTB ST i25 //
WTB ST i25

Shimano HB-RS470 12x100 mm

Shimano FH-MT400 12x142 mm

Racktime Light IT 2.0

Curana Apollo 55

Lezyne Hecto Pro 65

Lezyne Hecto Pro 65

GRÖSSE	ARTIKELNUMMER	LAUFRADGRÖSSE
XS	31AK1015	28
S	31AK1016	28
M	31AK1017	28
L	31AK1018	28
XL	31AK1019	28



met. light grey / shark blue - matt / glossy



URBAN ASKET

ASKET AL

GHOST Carbon

Ghost Dia. 31.8 mm

Ground Fiftyone Dia. 31.8 mm 660 mm

Shimano Sora RD-R3000 9-S

Shimano Sora FD-R3030

Shimano Sora SL-R3000

FSA CK-C201ST 46-30T

Shimano CS-HG400-9 11-34

Shimano BR-RS305 160 mm Disc

GND 51 27.2 mm

Selle Royal SRX

Acros

Feimin FP-B908N

FRHG0065

Velo VLG-1751D2

Maxxis Roamer 44-622 //
Maxxis Roamer 44-622

WTB ST i25 //
WTB ST i25

Shimano HB-RS470 12x100 mm

Shimano FH-MT400 12x142 mm

GRÖSSE	ARTIKELNUMMER	LAUFRADGRÖSSE
XS	31AK1055	28
S	31AK1056	28
M	31AK1057	28
L	31AK1058	28
XL	31AK1059	28





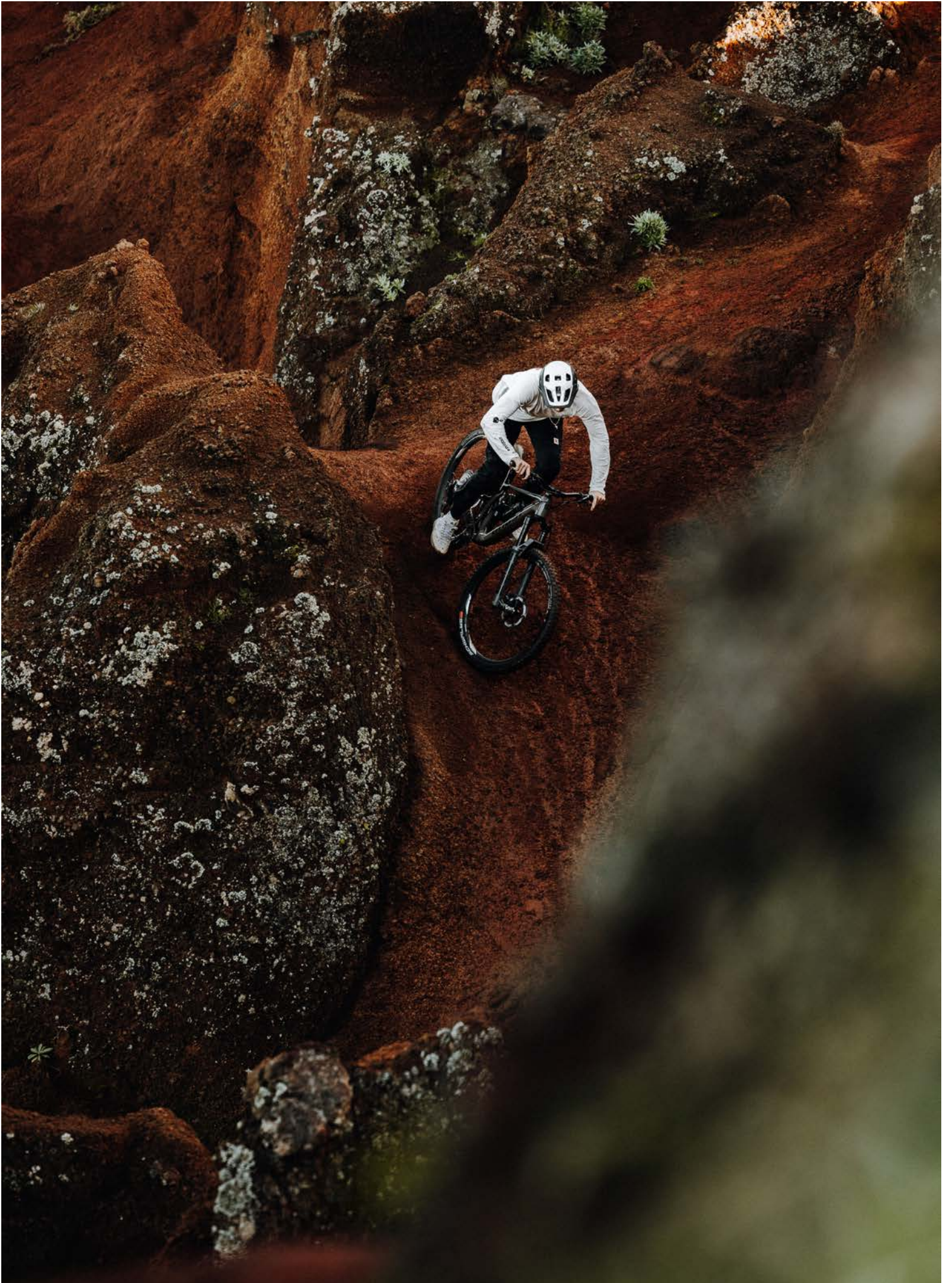

BIKES

ASKET

RIOT

LECTOR

NIRVANA

KATO

LANAO

YOUTH

KIDS

SQUARE



metallic dark brown/metallic bright orange - matt



SUPER FIT
by GHOST



RIOT EN PRO

RIOT AL

Fox 38 Float Performance Elite GRIP2 170 mm

Fox DHX2 Performance Elite 160 mm

Syntace Megaforce2 Dia. 31.8 mm

Syntace Vector 7075 high20 780 mm

Shimano XT RD-M8100 12-S

Shimano XT SL-M8100

Race Face Aeffect R 32T

Shimano SLX CS-M7100 10-51

Formula Cura 4 203 mm

Syntace V30 15x110 mm //
Syntace V30 12x148 mm

Eightpins hydraulic 34.9 mm

Prologo Proxim W400 Performance

Acros Blocklock 135° AZX-582

Race Face BSA 68/73

SRAM UDH

WTB Wafel

Maxxis Assegai 3C MaxxGrip Exo+ 2.5 //
Maxxis Minion DHR II 3C MaxxTerra Double Down 2.4

GRÖSSE	ARTIKELNUMMER	LAUFRADGRÖSSE
S	24R11037	
M	24R11038	
L	24R11039	
XL	24R11040	





deep grey/metallic dark blue - matt

SUPER FIT
by GHOST



RIOT EN ADVANCED

RIOT AL

Fox 38 Float Rhythm 170 mm

Fox DHX Performance 160 mm

Ghost Dia. 31.8 mm

Ghost MTB Dia. 31.8 mm 800/15 mm

Shimano XT RD-M8100 12-S

Shimano SLX SL-M7100

Shimano SLX FC-M7100 32T

Shimano Deore CS-M6100 10-51

Shimano Deore BR-M6120 203 mm

Eightpins hydraulic 34.9 mm

Prologo Proxim W400 Performance

Acros Blocklock 135° AZX-582

Shimano BB-MT801

SRAM UDH

Switch Components Kaleido

Maxxis Assegai 3C MaxxGrip Exo+ 2.5 //
Maxxis Minion DHR II 3C MaxxTerra Double Down 2.4

WTB ST i30 //
WTB ST i30

Shimano HB-TC500-15-B 15x110 mm

Shimano FH-TC500-MS-B 12x148 mm

GRÖSSE	ARTIKELNUMMER	LAUFRADGRÖSSE
S	24R11031	27.5
M	24R11032	29
L	24R11033	29
XL	24R11034	29



met. rust dark red/light dust - matt

SUPER FIT
by GHOST



RIOT EN

RIOT AL

Rock Shox Domain RC 170 mm

Rock Shox Super Deluxe Coil Select 160 mm

Ghost Dia. 31.8 mm

Ghost MTB Dia. 31.8 mm 800/15 mm

SRAM NX Eagle 12-S

SRAM NX Eagle

SRAM Descendant 6K Eagle 32T

SRAM PG-1230 11-50

SRAM Code R 200 mm

Ghost Alpha 1 34.9 mm 125 (S) 150 (M) 170 (L/XL)

Prologo Proxim W400 Performance

Acros Blocklock 135° AZX-582

SRAM DUB BSA

SRAM UDH

Switch Components Kaleido

Maxxis Assegai 3C MaxxGrip Exo+ 2.5 //
Maxxis Minion DHR II 3C MaxxTerra Double Down 2.4

WTB ST i30 //
WTB ST i30

Shimano HB-TC500-15-B 15x110 mm

Shimano FH-TC500-HM-B 12x148 mm

GRÖSSE	ARTIKELNUMMER	LAUFRADGRÖSSE
S	24R11025	27.5
M	24R11026	29
L	24R11027	29
XL	24R11028	29





warm grey / dark chocolate - glossy

SUPER FIT
by GHOST



RIOT AM FULL PARTY

RIOT CF

Fox 38 Float Factory GRIP2 160 mm

Fox Float X2 Factory 140 mm

Ground Fiftyone Dia. 31.8 mm

Ground Fiftyone Dia. 31.8 mm 760/15 (S) 800/27 (M-XL)

Shimano XT RD-M8100 12-S

Shimano SLX SL-M7100

Shimano FC-MT512 32T

Shimano SLX CS-M7100 10-51

Formula Cura 4 203 mm Disc

Syntace V30 15x110 mm //
Syntace V30 12x148 mm

Eightpins hydraulic 34.9 mm

WTB Volt

Acros Blocklock 135° AZX-582

Shimano BSA

SRAM UDH

WTB Wafel

Maxxis Assegai 3C MaxxGrip Exo+ 2.5 //
Maxxis Dissector 3C MaxxGrip Double Down 2.4

GRÖSSE	ARTIKELNUMMER	LAUFRADGRÖSSE
S	31R11018	29
M	31R11019	29
L	31R11020	29
XL	31R11021	29



grey 1 / pearl light grey - glossy

SUPER FIT
by GHOST



RIOT AM PRO

RIOT CF

Rock Shox ZEB Base 160 mm

Rock Shox Super Deluxe Select+ RT 140 mm

Ground Fiftyone Dia. 31.8 mm

Ground Fiftyone Dia. 31.8 mm 760/15 (S) 800/27 (M-XL)

Shimano XT RD-M8100 12-S

Shimano SLX SL-M7100

Shimano FC-MT512 32T

Shimano Deore CS-M6100 10-51

Formula Cura 4 203 mm Disc

Eightpins hydraulic 34.9 mm

WTB Volt

Acros Blocklock 135° AZX-582

Shimano BSA

SRAM UDH

WTB Wafel

Maxxis Assegai 3C MaxxGrip Exo+ 2.5 //
Maxxis Dissector 3C MaxxGrip Double Down 2.4

WTB ST Light i30 //
WTB ST Light i30

DT Swiss 370 Classic 15x110 mm

DT Swiss 370 Classic 12x148 mm

GRÖSSE	ARTIKELNUMMER	LAUFRADGRÖSSE
S	31R11012	29
M	31R11013	29
L	31R11014	29
XL	31R11015	29





pearl warm grey/metallic mud green - glossy

SUPER FIT
by GHOST



RIOT AM

RIOT AL

Rock Shox Yari RC 160 mm

Rock Shox Super Deluxe Select+ RT 150 mm

Ghost Dia. 31.8 mm

Ghost MTB Dia. 31.8 mm 800/15 mm

SRAM NX Eagle 12-S

SRAM NX Eagle

SRAM SX Eagle 32T

SRAM PG-1230 11-50

SRAM G2 R 200 mm

Ghost Alpha 1 34.9 mm 125 (S) 150 (M) 170 (L/XL)

Prologo Proxim W400 Performance

Acros Blocklock 135° AZX-582

SRAM DUB BSA

SRAM UDH

Switch Components Kaleido

Maxxis Minion DHF 3C MaxxTerra Exo+ 2.5 //
Maxxis Minion DHR II 3C MaxxTerra Exo+ 2.4

WTB ST i30 //
WTB ST i30

Shimano HB-TC500-15-B 15x110 mm

Shimano FH-TC500-HM-B 12x148 mm

GRÖSSE	ARTIKELNUMMER	LAUFRADGRÖSSE
S	24R11013	27.5
M	24R11014	29
L	24R11015	29
XL	24R11016	29



carbon / met. dirty blue - matt

SUPER FIT
by GHOST



RIOT TRAIL FULL PARTY

RIOT CF

Fox 36 Float Factory FIT4 150 mm

Fox Float X Factory 140 mm

Ground Fiftyone Dia. 31.8 mm

Ground Fiftyone Dia. 31.8 mm 760/15 (S) 800/27 (M-XL)

Shimano XT RD-M8100 12-S

Shimano SLX SL-M7100

Shimano FC-MT512 32T

Shimano SLX CS-M7100 10-51

Formula Cura 4 203 mm Disc

Syntace V30 15x110 mm //
Syntace V30 12x148 mm

Eightpins hydraulic 34.9 mm

WTB Volt

Acros Blocklock 135° AZX-582

Shimano BSA

SRAM UDH

WTB Wafel

Maxxis Assegai 3C MaxxGrip Exo+ 2.5 //
Maxxis Dissector 3C MaxxGrip Double Down 2.4

GRÖSSE	ARTIKELNUMMER	LAUFRADGRÖSSE
S	31R11006	29
M	31R11007	29
L	31R11008	29
XL	31R11009	29



carbon / light kaki - matt

SUPER FIT
by GHOST



RIOT TRAIL PRO

RIOT CF

Rock Shox Lyrik Select 150 mm

Rock Shox Super Deluxe Select+ RT 140 mm

Ground Fiftyone Dia. 31.8 mm

Ground Fiftyone Dia. 31.8 mm 760/15 (S) 800/27 (M-XL)

Shimano XT RD-M8100 12-S

Shimano SLX SL-M7100

Shimano FC-MT512 32T

Shimano Deore CS-M6100 10-51

Formula Cura 4 203 mm Disc

Eightpins hydraulic 34.9 mm

WTB Volt

Acros Blocklock 135° AZX-582

Shimano BSA

SRAM UDH

WTB Wafel

Maxxis Assegai 3C MaxxGrip Exo+ 2.5 //
Maxxis Dissector 3C MaxxGrip Double Down 2.4

WTB ST Light i30 //
WTB ST Light i30

DT Swiss 370 Classic 15x110 mm

DT Swiss 370 Classic 12x148 mm

GRÖSSE	ARTIKELNUMMER	LAUFRADGRÖSSE
S	31R11000	29
M	31R11001	29
L	31R11002	29
XL	31R11003	29





metallic anthrazit/metallic red copper - glossy



SUPER FIT
by GHOST



RIOT TRAIL

RIOT AL

Rock Shox Recon Gold RL 140 mm

SR Suntour Edge LOR8 140 mm

Ghost Dia. 31.8 mm

Ghost MTB Dia. 31.8 mm 800/15 mm

Shimano XT RD-M8100 12-S

Shimano SLX SL-M7100

Shimano Deore FC-M6100 32T

Shimano SLX CS-M7100 10-51

Shimano BR-MT500 180 mm

Ghost Alpha 1 34.9 mm 125 (S) 150 (M) 170 (L/XL)

Prologo Proxim W400 Performance

Acros Blocklock 135° AZX-582

Shimano BB-MT801

SRAM UDH

Switch Components Kaleido

Schwalbe Nobby Nic Performance 2.4 //
Schwalbe Nobby Nic Performance 2.4

WTB ST i30 //
WTB ST i30

Shimano HB-TC500-15-B 15x110 mm

Shimano FH-TC500-MS-B 12x148 mm

GRÖSSE	ARTIKELNUMMER	LAUFRADGRÖSSE
S	24R11001	27.5
M	24R11002	29
L	24R11003	29
XL	24R11004	29





BIKES

ASKET

RIOT

LECTOR

NIRVANA

KATO

LANAO

YOUTH

KIDS

SQUARE

silver 70%/carbon showing 70%/black 70% - glossy



SUPER FIT
by GHOST



LECTOR FS WORLD CUP „30“

Lector FS LC

Rock Shox SID Ultimate 3P 110 mm (XS-S) 120 mm (M-XL)

Rock Shox SIDLuxe Ultimate 3P 100 mm (XS-S) 120 mm (M-XL)

Truvativ Atmos 6K 31.8 mm

Truvativ Atmos Carbon Flat Bar 31.8 mm 760/0 mm

SRAM XX Eagle Transmission 12-S

SRAM AXS Pod Controller

SRAM XX SL Eagle Transmission 32T

SRAM CS XS 1299 T-Type 10-52

SRAM Level Ultimate 180 mm

DT Swiss XRC 1501 Spline One 30 mm 15x110 mm //
DT Swiss XRC 1501 Spline One 30 mm 12x148 mm

Rock Shox Reverb AXS 34.9 mm 100 (XS/S) 125 (M/L) 150 (XL)

Prologo Scratch M5 PAS

Acros Blocklock 135° AZX-582

SRAM PF DUB

SRAM UDH

SRAM Twistlock

Maxxis Ikon 3C MaxxSpeed Exo 2.35 //
Maxxis Ikon 3C MaxxSpeed Exo 2.35







GRÖSSE	ARTIKELNUMMER	LAUFRADGRÖSSE
XS	24LE1008	29
S	24LE1009	29
M	24LE1010	29
L	24LE1011	29
XL	24LE1012	29















pearl dark blue / super light green - matt



LECTOR FS PRO

-  LECTOR FS LC
-  Fox 34 Float SC Factory FIT4 Remote 100 mm (XS-S) 120 mm (M-XL)
-  Fox Float DPS Factory Remote 100 mm (XS-S) 120 mm (M-XL)
-  Ground Fiftyone Dia. 31.8 mm
-  Ground Fiftyone Dia. 31.8 mm 700 mm (XS) 720 mm (S) 740 mm (M-L) 760 mm (XL)
-  Shimano XTR RD-M9100 12-S

-  Shimano XTR SL-M9100
-  Race Face Next SL 32T
-  Shimano XTR CS-M9100 10-51
-  Shimano XTR BR-M9100 180 mm Disc
-  Ghost Carbon Wheelset 26 mm 15x110 mm // Ghost Carbon Wheelset 26 mm 12x148 mm
-  Eightpins mechanical 34.9 mm

-  Selle Italia SLR Boost
-  Acros Blocklock AZX-220-R4
-  Race Face Pressfit
-  SRAM UDH
-  ESI Grip Racer's Edge
-  Maxxis Recon Race Exo 2.35 // Maxxis Recon Race Exo 2.35

GRÖSSE	ARTIKELNUMMER	LAUFRADGRÖSSE
XS	31LE2022	29
S	31LE2023	29
M	31LE2024	29
L	31LE2025	29
XL	31LE2026	29



carbon / met. petrol - glossy

SUPER FIT
by GHOST



LECTOR FS ADVANCED

LECTOR FS LC

Rock Shox SID Select+ RL R 100 mm (XS-S) 120 mm (M-XL)

Rock Shox SIDLuxe Select+ RL 100 mm (XS-S) 120 mm (M-XL)

Ground Fiftyone Dia. 31.8 mm

Ground Fiftyone Dia. 31.8 mm 700 mm (XS) 720 mm (S) 740 mm (M-L) 760 mm (XL)

SRAM X01 Eagle 12-S

SRAM X01 Eagle

SRAM X01 Eagle 32T

SRAM XG 1275 10-52

Formula Cura 2 180 mm Disc

Syntace W28i 15x110 mm //
Syntace W28i 12x148 mm

Eightpins mechanical 34.9 mm

Selle Italia SLR Boost

Acros Blocklock AZX-220-R4

SRAM Pressfit DUB

GW UDH

ESI Grip Racer's Edge

Maxxis Ikon 3C MaxxSpeed Exo 2.35 //
Maxxis Ikon 3C MaxxSpeed Exo 2.35

GRÖSSE	ARTIKELNUMMER	LAUFRADGRÖSSE
XS	31LE2015	29
S	31LE2016	29
M	31LE2017	29
L	31LE2018	29
XL	31LE2019	29



carbon / dark grey - glossy

SUPER FIT
by GHOST



LECTOR FS ESSENTIAL

LECTOR FS LC

Fox 34 Float SC Performance Remote 100 mm (XS-M) 120 mm (L-XL)

Fox Float DPS Performance Elite Remote 100 mm (XS-S) 120 mm (M-XL)

Ground Fiftyone Dia. 31.8 mm

Ground Fiftyone Dia. 31.8 mm 700 mm (XS) 720 mm (S) 740 mm (M-L) 760 mm (XL)

Shimano XT RD-M8100 12-S

Shimano Deore SL-M6100

Shimano FC-MT510 32T

Shimano Deore CS-M6100 10-51

Formula Cura 2 180 mm Disc

Syntace V30 15x110 mm // Syntace V30 12x148 mm

GND 51 Carbon 34.9 mm

Selle Italia X3 Boost

Acros Blocklock AZX-220-R4

Shimano BB-MT800

GW UDH

WTB Trail II

Schwalbe Racing Ralph Performance 2.25 // Schwalbe Racing Ralph Performance 2.25

GRÖSSE	ARTIKELNUMMER	LAUFRADGRÖSSE
XS	31LE2001	29
S	31LE2002	29
M	31LE2003	29
L	31LE2004	29
XL	31LE2005	29





LECTOR WORLD CUP „30“

Lector UC

Rock Shox SID Ultimate 3P 110 mm (XS-M) 120 mm (L-XL)

FSA KFX SIC Integrated Handlebar

FSA KFX SIC Integrated Handlebar 31.8 mm 780/ 5 mm

SRAM XX Eagle Transmission 12-S

SRAM AXS Pod Controller

SRAM XX SL Eagle Transmission 32T

SRAM CS XS 1299 T-Type 10-52

SRAM Level Ultimate 180 mm

DT Swiss XRC 1501 Spline One 30 mm 15x110 mm //
DT Swiss XRC 1501 Spline One 30 mm 12x148 mm

Rock Shox Reverb AXS 31.6 mm 100 (XS) 125 (S/M/L) 150 (XL)

Prologo Scratch M5 PAS

Acros

SRAM PF DUB

SRAM UDH

ESI Grip Racer's Edge

Maxxis Aspen Exo 2.4 //
Maxxis Aspen Exo 2.4

GRÖSSE	ARTIKELNUMMER	LAUFRADGRÖSSE
XS	24LE1036	29
S	24LE1037	29
M	24LE1038	29
L	24LE1039	29
XL	24LE1040	29





carbon showing/met. blue grey - glossy



LECTOR PRO

Lector CF

Fox Float 34 SC Performance Remote 110 mm (XS-M) 120 mm (L-XL)

FSA SL-K Drop 31.8 mm

FSA KFX Carbon Flat 760/0 mm

Shimano XT RD-M8100 12-S

Shimano XT SL-M8100

Shimano XT FC-M8120 32T

Shimano XT CS-M8100 10-51

Formula Cura 2 180 / 160 mm

DT Swiss X1900 Spline 30 mm 15x110 mm // DT Swiss X1900 Spline 30 mm 12x148mm

FSA KFX S80 Carbon 31.6 mm

Prologo Scratch M5 PAS

Acros

Shimano BB-MT800-PA

SRAM UDH

ESI Grip Racer's Edge

Maxxis Aspen Exo 2.4 // Maxxis Aspen Exo 2.4

GRÖSSE	ARTIKELNUMMER	LAUFRADGRÖSSE
XS	24LE1029	29
S	24LE1030	29
M	24LE1031	29
L	24LE1032	29
XL	24LE1033	29



pearl dark blue/pearl light grey - glossy



LECTOR ADVANCED

Lector LC

Rock Shox SID Base 2P 110 mm (XS-M) 120 mm (L-XL)

Ghost Dia. 31.8 mm

Ground Fiftyone Dia. 31.8 mm 760/0 mm

SRAM GX Eagle 12-S

SRAM NX Eagle

SRAM GX Eagle 32T

SRAM PG-1230 11-50

Formula Cura 2 180 / 160 mm

Ghost 31.6 mm

Selle Italia SLS

Acros

SRAM PF DUB

SRAM UDH

ESI Grip Racer's Edge

Maxxis Aspen Exo 2.4 //
Maxxis Aspen Exo 2.4

WTB ST Light i25 //
WTB ST Light i25

Shimano HB-TC500-15-B 15x110 mm

Shimano FH-TC500-HM-B 12x148 mm

GRÖSSE	ARTIKELNUMMER	LAUFRADGRÖSSE
XS	24LE1022	29
S	24LE1023	29
M	24LE1024	29
L	24LE1025	29
XL	24LE1026	29



carbon showing/met. rust red - glossy



LECTOR UNIVERSAL

Lector LC

Rock Shox Recon Silver RL 110 mm (XS-M) 120 mm (L-XL)

Ghost Dia. 31.8 mm

Ground Fiftyone Dia. 31.8 mm 760/0 mm

Shimano XT RD-M8100 12-S

Shimano Deore SL-M6100

Shimano FC-MT512 32T

Shimano Deore CS-M6100 10-51

Shimano BR-MT520 / BR-MT500 180 mm

Ghost 31.6 mm

Selle Italia SLS

Acros

Shimano BB-MT500-PA

SRAM UDH

ESI Grip Racer's Edge

Maxxis Aspen Exo 2.4 //
Maxxis Aspen Exo 2.4

WTB ST Light i25 //
WTB ST Light i25

Shimano HB-TC500-15-B 15x110 mm

Shimano FH-TC600-MS-B 12x148 mm

GRÖSSE	ARTIKELNUMMER	LAUFRADGRÖSSE
XS	24LE1015	29
S	24LE1016	29
M	24LE1017	29
L	24LE1018	29
XL	24LE1019	29



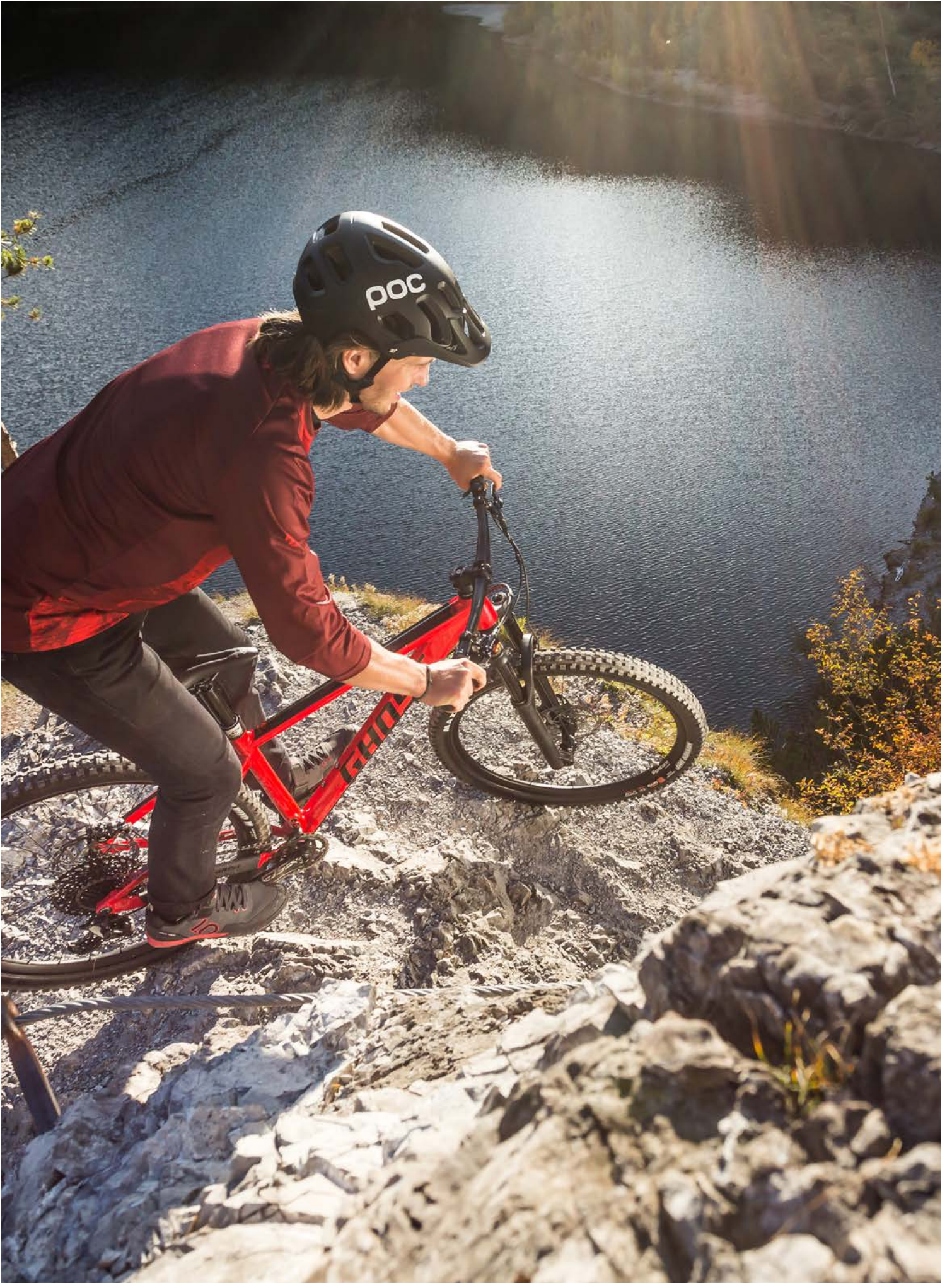

BIKES



ASKET

RIOT

LECTOR

NIRVANA

KATO

LANAO

YOUTH

KIDS

SQUARE

green / riot red - glossy

SUPER FIT
by GHOST



NIRVANA TRAIL UNIVERSAL

NIRVANA AL

Rock Shox Recon Silver RL 140mm

Ground Fiftyone Dia. 31.8 mm

Ground Fiftyone Race Dia. 31.8 mm
0/700 mm (XS/S) 20/720 mm (M) 27/740 mm (L) 40/760 mm (XL)

SRAM GX Eagle 12-S

SRAM SX Eagle

Truvativ Stylo 6K 32T

SRAM PG-1210 11-50

Shimano BR-MT410 180 mm Disc

Eightpins hydraulic 34.9 mm

WTB Volt

Strummer Semi-integrated

SRAM Powerspline 118/73

FRHG0025

WTB Wafel

Schwalbe Nobby Nic Super Trail Addix Soft 2.4 //
Schwalbe Nobby Nic Super Ground Addix Speed Grip 2.4

WTB ST i25 //
WTB ST i25

Shimano HB-MT400-B 15x110 mm

Shimano FH-MT410-B 12x148 mm

GRÖSSE	ARTIKELNUMMER	LAUFRADGRÖSSE
S	93NI1030	27.5
M	93NI1031	29
L	93NI1032	29
XL	93NI1033	29



light grey/riot red - glossy

SUPER FIT
by GHOST



NIRVANA TOUR UNIVERSAL

NIRVANA AL

Rock Shox Recon Silver RL 100 mm (XS) 120 mm (S-XL)

Ghost Dia. 31.8 mm

Ground Fiftyone Race Dia. 31.8 mm 700/0 mm (XS/S) 720/20 mm (M) 740/27 mm (L) 760/40 mm (XL)

SRAM X01 Eagle 12-S

SRAM SX Eagle

Truvativ Stylo 6K 32T

SRAM PG-1210 11-50

Shimano BR-MT410 180 mm

Ghost 34.9 mm

Selle Italia adjustable

Strummer semi-integrated

SRAM Power Spline 118/73

FRHG0025

Production Privee CR35

Maxxis Aggressor 27.5x2.35 // Maxxis Forekaster 29x2.35 // Maxxis Aggressor 27.5x2.35 // Maxxis Forekaster 29x2.35

WTB ST i25 // WTB ST i25

Shimano HB-TC500-15-B 15x110 mm

Shimano FH-TC500-HM-B 12x148 mm

GRÖSSE	ARTIKELNUMMER	LAUFRADGRÖSSE
XS	24NI1008	27.5
S	24NI1009	27.5
M	24NI1010	29
L	24NI1011	29
XL	24NI1012	29



dark blue pearl / bright blue - glossy

SUPER FIT
by GHOST



NIRVANA TOUR UNIVERSAL

NIRVANA AL

Rock Shox Recon Silver RL
100 mm (XS) 120 mm (S-XL)

Ground Fiftyone Dia. 31.8 mm

Ground Fiftyone Race Dia. 31.8 mm
0/700 mm (XS/S) 20/720 mm (M) 27/740 mm (L) 40/760 mm (XL)

SRAM X01 Eagle 12-S

SRAM SX Eagle

Truvativ Stylo 6K 32T

SRAM PG-1210 11-50

Shimano SM-RT30 180 mm

GND 51 34.9 mm

Selle Italia Adjustable

Strummer Semi-integrated

SRAM Powerspline 118/73

FRHG0025

Production Privee CR35

Schwalbe Nobby Nic Performance 2.35 (XS-S 27,5"; M-XL 29")
Schwalbe Nobby Nic Performance 2.35 (XS-S 27,5"; M-XL 29")

WTB ST i25 //
WTB ST i25

Shimano HB-MT400-B 15x110 mm

Shimano FH-MT410-B 12x148 mm

GRÖSSE	ARTIKELNUMMER	LAUFRADGRÖSSE
XS	93NI1022	27.5
S	93NI1023	27.5
M	93NI1024	29
L	93NI1025	29
XL	93NI1026	29



metallic kaki / warm grey pearl - matt

SUPER FIT
by GHOST



NIRVANA TOUR ESSENTIAL

NIRVANA AL

SR Suntour Raidon 32 LOR DS
100 mm (XS) 120 mm (S-XL)

Ground Fiftyone Dia. 31.8 mm

Ground Fiftyone Race Dia. 31.8 mm
0/700 mm (XS/S) 20/720 mm (M) 27/740 mm (L) 40/760 mm (XL)

Shimano XT RD-M8100 12-S

Shimano Deore SL-M6100

Shimano FC-MT511 32T

Shimano Deore CS-M6100 10-51

Tektro HD-M275 180 mm

GND 51 34.9 mm

Selle Italia Adjustable

Strummer Semi-integrated

BSA

FRHG0025

Production Privee CR35

WTB Ranger 2.3 Comp //
WTB Ranger 2.3 Comp

Schürmann Yak Disc 25 //
Schürmann Yak Disc 25

Shimano HB-MT400-B 15x110 mm

Shimano FH-MT410-B 12x148 mm

GRÖSSE	ARTIKELNUMMER	LAUFRADGRÖSSE
XS	93NI1015	27.5
S	93NI1016	27.5
M	93NI1017	29
L	93NI1018	29
XL	93NI1019	29





metallic black/metallic bright orange - glossy



SUPER FIT
by GHOST



NIRVANA TOUR

NIRVANA AL

SR Suntour XCR32 Air LOR DS 100 mm (XS) 120 mm (S-XL)

Ghost Dia. 31.8 mm

Ground Fiftyone Race Dia. 31.8 mm 700/0 mm (XS/S) 720/20 mm (M) 740/27 mm (L) 760/40 mm (XL)

SRAM SX Eagle 12-S

SRAM SX Eagle

SRAM SX Eagle 32T

SRAM PG-1210 11-50

Tektro HD-M275 180 mm

Ghost 34.9 mm

Selle Italia adjustable

Strummer semi-integrated

SRAM Power Spline 118/73

FRHG0025

Production Privee CR35

WTB Ranger 2.3 Comp //
WTB Ranger 2.3 Comp

Schürmann Yak Disc 25 //
Schürmann Yak Disc 25

Shimano HB-TC500-15-B 15x110 mm

Shimano FH-TC500-HM-B 12x148 mm

GRÖSSE	ARTIKELNUMMER	LAUFRADGRÖSSE
XS	24NI1001	27.5
S	24NI1002	27.5
M	24NI1003	29
L	24NI1004	29
XL	24NI1005	29



light grey pearl / dark grey - glossy

SUPER FIT
by GHOST



NIRVANA TOUR

NIRVANA AL

SR Suntour XCR32
100 mm (XS) 120 mm (S-XL)

Ground Fiftyone Dia. 31.8 mm

Ground Fiftyone Race Dia. 31.8 mm
0/700 mm (XS/S) 20/720 mm (M) 27/740 mm (L) 40/760 mm (XL)

SRAM SX Eagle 12-S

SRAM SX Eagle

SRAM SX Eagle 32T

SRAM PG-1210 11-50

Tektro HD-M275 180 mm

GND 51 34.9 mm

Selle Italia Adjustable

Strummer Semi-integrated

Sram Power Spline 118/73

FRHG0025

Production Privee CR35

WTB Ranger 2.3 Comp //
WTB Ranger 2.3 Comp

Schürmann Yak Disc 25 //
Schürmann Yak Disc 25

Shimano HB-MT400-B 15x110 mm

Shimano FH-MT400-B 12x148 mm

GRÖSSE	ARTIKELNUMMER	LAUFRADGRÖSSE
XS	93NI1001	27.5
S	93NI1002	27.5
M	93NI1003	29
L	93NI1004	29
XL	93NI1005	29





raw alu / chrome - glossy



NIRVANA 4X

NIRVANA 4x

X-Fusion Slant 34 RC 100 mm

Ground Fiftyone Dia. 35 mm

Ground Fiftyone Race Dia. 35 mm 20/780 mm

Shimano Deore FC-M5100 30T

Formula 13T

Shimano BR-MT410 160 mm Disc

JD-SP20T 34.9

Selle Italia Model X Superflow

Acros ZS44/56

BSA

FRHG0025

WTB Wafel

Maxxis DTH 26x2.30 //
Maxxis DTH 26x2.30

WTB ST Light i29 //
WTB ST Light i29

Shimano HB-MT400-B 15x110 mm

Shimano FH-MT400-B 12x148 mm

GRÖSSE ARTIKELNUMMER LAUFRADGRÖSSE

M

93NI1100

26



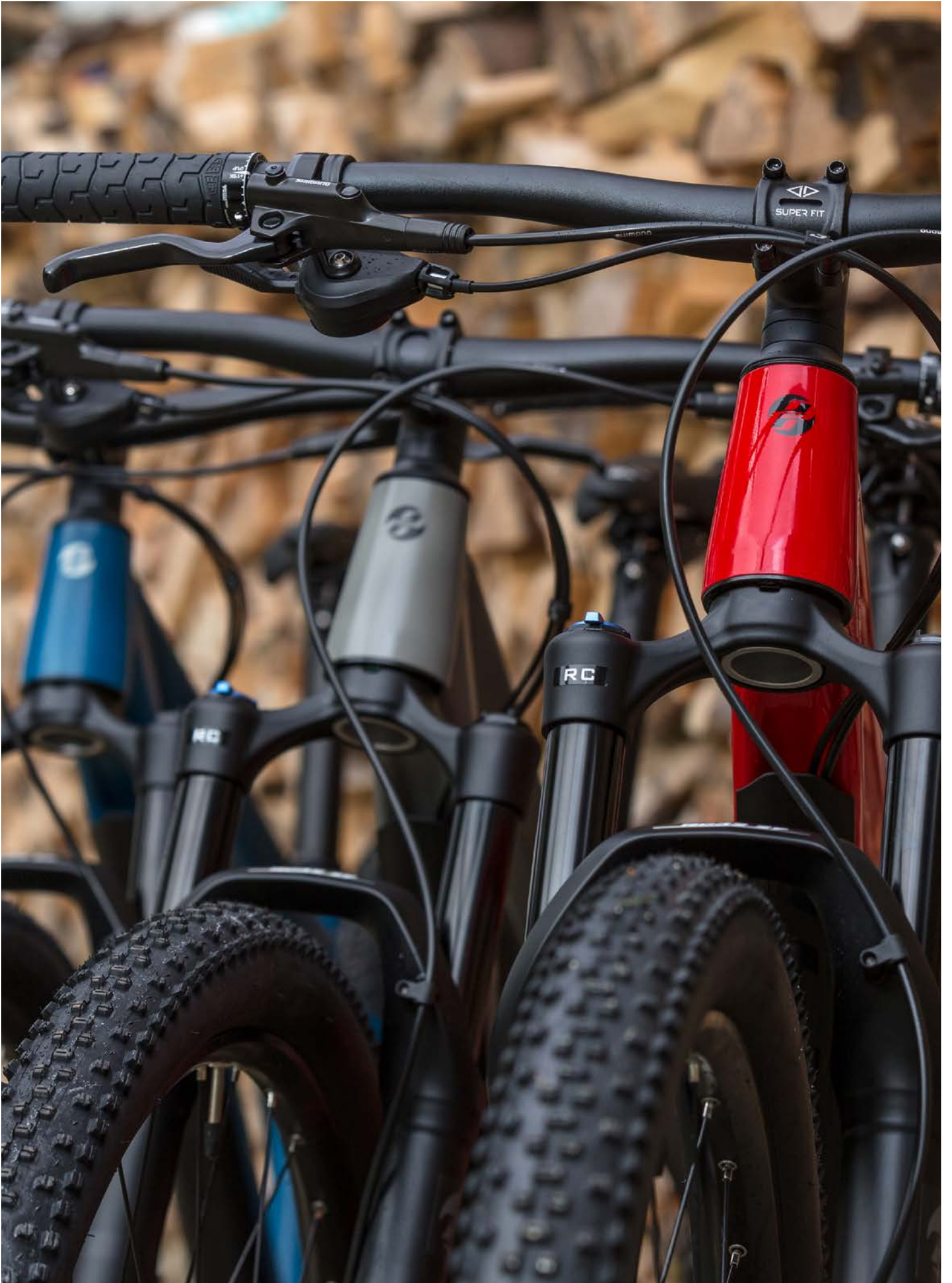

BIKES



ASKET

RIOT

LECTOR

NIRVANA

KATO

LANAO

YOUTH

KIDS

SQUARE

metallic dirty blue/pearl dark grey - glossy

SUPER FIT
by GHOST



KATO FS PRO

Kato FS AL

Fox 34 Float Rhythm 130 mm

Fox Float DPS Performance 130 mm

Ghost Dia. 31.8 mm

Ghost MTB Dia. 31.8 mm 800/15 mm

Shimano XT RD-M8100 12-S

Shimano Deore SL-M6100

Shimano FC-MT510 32T

Shimano Deore CS-M6100 10-51

Shimano BR-MT500 180 mm

Ghost Alpha 1 31.6 mm 125 (XS/S) 150 (M-XL)

Prologo Proxim W400 Performance

Strummer semi-integrated

Shimano BB-MT501

SRAM UDH

Switch Components Kaleido

WTB Ranger 2.3 Comp //
WTB Ranger 2.3 Comp

WTB ST i30 //
WTB ST i30

Shimano HB-TC500-15-B 15x110 mm

Shimano FH-TC500-MS-B 12x148 mm

GRÖSSE	ARTIKELNUMMER	LAUFRADGRÖSSE
XS	24KA1037	27.5
S	24KA1038	27.5
M	24KA1039	29
L	24KA1040	29
XL	24KA1041	29





blue green / monarch orange - matt



SUPER FIT
by GHOST



KATO FS UNIVERSAL

KATO FS AL

Rock Shox Recon Silver RL 130 mm

Rock Shox Deluxe Select R 130 mm

Ground Fiftyone Dia. 31.8 mm

Ground Fiftyone Dia. 31.8 mm
720mm (S) 740mm (M-L) 780mm (XL)

Shimano XT RD-M8100 12-S

Shimano Deore SL-M6100

Shimano FC-MT510 32T

Shimano Deore CS-M6100 10-51

Shimano BR-MT501 180 mm Disc

Limotec Alpha 1 31.6 mm
125 (XS/S) M-XL 150 (M-XL)

Selle Italia Model X Superflow

Strummer Semi-integrated

Shimano BB52 BSA

FRHG0061

MTB Grip

WTB Ranger 2.3 Comp //
WTB Ranger 2.3 Comp

WTB ST i30 //
WTB ST i30

Shimano HB-MT400-B 15x110 mm

Shimano FH-MT410-B 12x148 mm

GRÖSSE	ARTIKELNUMMER	LAUFRADGRÖSSE
XS	93KA2031	27.5
S	93KA2019	27.5
M	93KA2020	29
L	93KA2021	29
XL	93KA2022	29



pearl grey/light kaki - glossy

SUPER FIT
by GHOST



KATO FS ESSENTIAL

KATO FS AL

SR Suntour XCR34 Air 130 mm

SR Suntour Raidon R 130 mm

Ground Fiftyone Dia. 31.8 mm

Ground Fiftyone Dia. 31.8 mm
720mm (S) 740mm (M-L) 780mm (XL)

SRAM GX Eagle 12-S

SRAM SX Eagle

Truvativ Stylo 6K 32T

SRAM PG-1230 11-50

Shimano BR-MT410 180 mm Disc

Limotec Alpha 1 31.6 mm
125 (XS/S) M-XL 150 (M-XL)

Selle Italia Model X Superflow

Strummer Semi-integrated

SRAM Power Spline 118/73

FRHG0061

MTB Grip

WTB Ranger 2.3 Comp //
WTB Ranger 2.3 Comp

Schürmann Yak Disc 25 //
Schürmann Yak Disc 25

Shimano HB-MT400-B 15x110 mm

Shimano FH-MT410-B 12x148 mm

GRÖSSE	ARTIKELNUMMER	LAUFRADGRÖSSE
XS	24KA1030	27.5
S	24KA1031	27.5
M	24KA1032	29
L	24KA1033	29
XL	24KA1034	29





black / green bay metallic - matt



SUPER FIT
by GHOST



KATO FS ESSENTIAL

KATO FS AL

SR Suntour XCR34 Air 130 mm

SR Suntour Raidon R 130 mm

Ground Fiftyone Dia. 31.8 mm

Ground Fiftyone Dia. 31.8 mm
720mm (S) 740mm (M-L) 780mm (XL)

SRAM GX Eagle 12-S

SRAM SX Eagle

Truvativ Stylo 6K 32T

SRAM PG-1230 11-50

Shimano BR-MT410 180 mm Disc

Limotec Alpha 1 31.6 mm
125 (XS/S) M-XL 150 (M-XL)

Selle Italia Model X Superflow

Strummer Semi-integrated

SRAM Power Spline 118/73

FRHG0061

MTB Grip

WTB Ranger 2.3 Comp //
WTB Ranger 2.3 Comp

Schürmann Yak Disc 25 //
Schürmann Yak Disc 25

Shimano HB-MT400-B 15x110 mm

Shimano FH-MT410-B 12x148 mm

GRÖSSE	ARTIKELNUMMER	LAUFRADGRÖSSE
XS	93KA2029	27.5
S	93KA2013	27.5
M	93KA2014	29
L	93KA2015	29
XL	93KA2016	29



medium blue/metallic black blue - matt

SUPER FIT
by GHOST



KATO FS

KATO FS AL

SR Suntour XCR34 Coil 130 mm

SR Suntour Raidon R 130 mm

Ground Fiftyone Dia. 31.8 mm

Ground Fiftyone Dia. 31.8 mm
720mm (S) 740mm (M-L) 780mm (XL)

SRAM SX Eagle 12-S

SRAM SX Eagle

SRAM SX Eagle 32T

SRAM PG-1210 11-50

Shimano BR-MT200 180 mm Disc

GND 51 31.6 mm

Selle Italia Model X Superflow

Strummer semi-integrated

SRAM Power Spline 118/73

FRHG0061

MTB Grip

WTB Ranger 2.3 Comp //
WTB Ranger 2.3 Comp

Schürmann Yak Disc 25 //
Schürmann Yak Disc 25

Shimano HB-MT400-B 15x110 mm

Shimano FH-MT410-B 12x148 mm

GRÖSSE	ARTIKELNUMMER	LAUFRADGRÖSSE
XS	24KA1023	27.5
S	24KA1024	27.5
M	24KA1025	29
L	24KA1026	29
XL	24KA1027	29



light grey pearl / riot red - matt

SUPER FIT
by GHOST



KATO FS

KATO FS AL

SR Suntour XCR34 Coil 130 mm

SR Suntour Raidon R 130 mm

Ground Fiftyone Dia. 31.8 mm

Ground Fiftyone Dia. 31.8 mm
720mm (S) 740mm (M-L) 780mm (XL)

SRAM SX Eagle 12-S

SRAM SX Eagle

SRAM SX Eagle 32T

SRAM PG-1210 11-50

Shimano BR-MT200 180 mm Disc

GND 51 31.6 mm

Selle Italia Model X Superflow

Strummer semi-integrated

SRAM Power Spline 118/73

FRHG0061

MTB Grip

WTB Ranger 2.3 Comp //
WTB Ranger 2.3 Comp

Schürmann Yak Disc 25 //
Schürmann Yak Disc 25

Shimano HB-MT400-B 15x110 mm

Shimano FH-MT410-B 12x148 mm

GRÖSSE	ARTIKELNUMMER	LAUFRADGRÖSSE
XS	93KA2027	27.5
S	93KA2007	27.5
M	93KA2008	29
L	93KA2009	29
XL	93KA2010	29



light grey pearl / black - matt



KATO PRO

KATO AL

Rock Shox Judy TK R 100 mm

Ground Fiftyone Dia. 31.8 mm

Ground Fiftyone Dia. 31.8 mm
0/700 mm (XS) 0/720 mm (S) 0/740 mm (M-L) 0/760 (XL)

Shimano Deore RD-M6100 12-S

Shimano Deore SL-M6100

Shimano FC-MT510 32T

Shimano Deore CS-M6100 10-51

Shimano BR-MT200 180 mm Disc

GHOST SP DC1 31.6 mm

Selle Italia Model X Superflow

14106

Shimano BB52 BSA

FRHG0004

MTB Grip

Schwalbe Smart Sam 29x2.25 //
Schwalbe Smart Sam 29x2.25

Rodi Excalibur XC 19 //
Rodi Excalibur XC 19

Shimano HB-TX505 QR 100 mm

Shimano FH-MT401 QR 135 mm

GRÖSSE	ARTIKELNUMMER	LAUFRADGRÖSSE
S	93KA1108	29
M	93KA1109	29
L	93KA1110	29
XL	93KA1111	29



GRÖSSE	ARTIKELNUMMER	LAUFRADGRÖSSE
XS	93KA1040	27.5
S	93KA1041	27.5
M	93KA1042	27.5





metallic satin blue/metallic dark brown - glossy



KATO PRO

Kato AL

Rock Shox Judy TK R 100 mm

Ground Fiftyone Dia. 31.8 mm

Ground Fiftyone Dia. 31.8 mm 700/0 mm (XS) 720/0 mm (S) 740/0 mm (M)

Shimano Deore RD-M6100 12-S

Shimano Deore SL-M6100

Shimano FC-MT510 32T

Shimano Deore CS-M6100 10-51

Shimano BR-MT200 180 mm

Ghost 31.6 mm

Selle Italia MODEL X Superflow

14106

Shimano BB-MT501

MTB Grip

Maxxis Crossmark II 2.25 // Maxxis Crossmark II 2.25

Rodi Excalibur XC 19 // Rodi Excalibur XC 19

Shimano HB-QC400 QR

Shimano FH-MT401 QR

GRÖSSE	ARTIKELNUMMER	LAUFRADGRÖSSE
S	24KA1017	29
M	24KA1018	29
L	24KA1019	29
XL	24KA1020	29



GRÖSSE	ARTIKELNUMMER	LAUFRADGRÖSSE
XS	24KA1012	27.5
S	24KA1013	27.5
M	24KA1014	27.5





KATO ADVANCED

KATO AL

SR Suntour XCR RL-R AIR 100 mm

Ground Fiftyone Dia. 31.8 mm

Ground Fiftyone Dia. 31.8 mm
0/700 mm (XS) 0/720 mm (S) 0/740 mm (M-L) 0/760 (XL)

Shimano CUES RD-U6020 10-S

Shimano CUES FD-U6000-M

Shimano CUES SL-U6000-10

Shimano CUES FC-U6000-2 36-22T

Shimano CUES CS-LG300-10 11-39

Shimano BR-MT200 180 mm Disc

GHOST SP DC1 31.6 mm

Selle Italia MODEL X Superflow

14106

Shimano BB52 BSA

FRHG0004

MTB Grip

Schwalbe Smart Sam 29x2.25 //
Schwalbe Smart Sam 29x2.25

Rodi Excalibur XC 19 //
Rodi Excalibur XC 19

Shimano HB-TX505 QR 100 mm

Shimano FH-TX505 QR 135 mm

GRÖSSE	ARTIKELNUMMER	LAUFRADGRÖSSE
S	93KA1096	29
M	93KA1097	29
L	93KA1098	29
XL	93KA1099	29



GRÖSSE	ARTIKELNUMMER	LAUFRADGRÖSSE
XS	93KA1030	27.5
S	93KA1031	27.5
M	93KA1032	27.5



metallic black/urban grey - glossy



KATO ADVANCED

Kato AL

SR Suntour XCR Air RL-R 100 mm

Ground Fiftyone Dia. 31.8 mm

Ground Fiftyone Dia. 31.8 mm 700/0 mm (XS) 720/0 mm (S) 740/0 mm (M-L) 760/0 (XL)

Shimano CUES RD-U6020 10-S

Shimano CUES FD-U6000-M

Shimano CUES SL-U6000-10

Shimano CUES FC-U6000-2 36-22T

Shimano CUES CS-LG300-10 11-39

Alhonga HT472 180 mm

Ghost 31.6 mm

Selle Italia MODEL X Superflow

14106

Shimano BB-MT501

MTB Grip

Maxxis Crossmark II 2.25 // Maxxis Crossmark II 2.25

Rodi Excalibur XC 19 // Rodi Excalibur XC 19

Shimano HB-QC400 QR

Shimano FH-QC400-HM QR

GRÖSSE	ARTIKELNUMMER	LAUFRADGRÖSSE
S	24KA1006	29
M	24KA1007	29
L	24KA1008	29
XL	24KA1009	29



GRÖSSE	ARTIKELNUMMER	LAUFRADGRÖSSE
XS	24KA1001	27.5
S	24KA1002	27.5
M	24KA1003	27.5



black / bright blue - matt



KATO EQ

KATO AL	Shimano CS-HG-200-8 12-32	Mitas Ocelot 29x2.35 // Mitas Ocelot 29x2.35
RST Blaze 100 mm	Tektro HD-M275 180 mm	Schürmann Yak Disc 25 // Schürmann Yak Disc 25
Ground Fiftyone Dia. 31.8 mm	GHOST SP DC1 31.6 mm	Shimano HB-TX505 QR 100 mm
Ground Fiftyone Dia. 31.8 mm 0/700 mm (XS) 0/720 mm (S) 0/740 mm (M-L) 0/760 (XL)	Selle Italia Model X Superflow	Shimano FH-TX505 QR 135 mm
Shimano Acera RD-M3020 8-S	14106	SKS Veloflexx 65
Shimano Tourney FD-TY700-TS6	BB-Thun	Büchel Akku Sport
Shimano Altus SL-M315	FRHG0004	Büchel Tivoli
Shimano FC-TY301 42-34-24	MTB Grip	

GRÖSSE	ARTIKELNUMMER	LAUFRADGRÖSSE
S	93KA1120	29
M	93KA1121	29
L	93KA1122	29
XL	93KA1123	29



GRÖSSE	ARTIKELNUMMER	LAUFRADGRÖSSE
XS	93KA1050	27.5
S	93KA1051	27.5
M	93KA1052	27.5



metallic kaki / black - matt



KATO EQ

KATO AL	Shimano CS-HG-200-8 12-32	Mitas Ocelot 29x2.35 // Mitas Ocelot 29x2.35
RST Blaze 100 mm	Tektro HD-M275 180 mm	Schürmann Yak Disc 25 // Schürmann Yak Disc 25
Ground Fiftyone Dia. 31.8 mm	GHOST SP DC1 31.6 mm	Shimano HB-TX505 QR 100 mm
Ground Fiftyone Dia. 31.8 mm 0/700 mm (XS) 0/720 mm (S) 0/740 mm (M-L) 0/760 (XL)	Selle Italia Model X Superflow	Shimano FH-TX505 QR 135 mm
Shimano Acera RD-M3020 8-S	14106	SKS Veloflexx 65
Shimano Tourney FD-TY700-TS6	BB-Thun	Büchel Akku Sport
Shimano Altus SL-M315	FRHG0004	Büchel Tivoli
Shimano FC-TY301 42-34-24	MTB Grip	

GRÖSSE	ARTIKELNUMMER	LAUFRADGRÖSSE
S	93KA1125	29
M	93KA1126	29
L	93KA1127	29
XL	93KA1128	29



GRÖSSE	ARTIKELNUMMER	LAUFRADGRÖSSE
XS	93KA1054	27.5
S	93KA1055	27.5
M	93KA1056	27.5



bluegreen pearl / azur blue metallic - glossy



KATO UNIVERSAL

KATO AL

Rock Shox Judy TK R 100 mm

Ground Fiftyone Dia. 31.8 mm

Ground Fiftyone Dia. 31.8 mm
0/700 mm (XS) 0/720 mm (S) 0/740 mm (M-L) 0/760 (XL)

Shimano CUES RD-U3020 9-S

Shimano CUES FD-U4000

Shimano CUES SL-U4010

Shimano CUES FC-U4000 36-22

Shimano CUES CS-LG300-9 11-36

Tektro HD-M275 180 mm

GHOST SP DC1 31.6 mm

Selle Italia MODEL X Superflow

14106

BB-Thun

FRHG0004

MTB Grip

Mitas Ocelot 29x2.35 //
Mitas Ocelot 29x2.35

Rodi Excalibur XC 19 //
Rodi Excalibur XC 19

Shimano HB-TX505 QR 100 mm

Shimano FH-TX505 QR 135 mm

GRÖSSE	ARTIKELNUMMER	LAUFRADGRÖSSE
S	93KA1089	29
M	93KA1090	29
L	93KA1091	29
XL	93KA1092	29



GRÖSSE	ARTIKELNUMMER	LAUFRADGRÖSSE
XS	93KA1024	27.5
S	93KA1025	27.5
M	93KA1026	27.5



black / bright blue - glossy



KATO UNIVERSAL

KATO AL

Rock Shox Judy TK R 100 mm

Ground Fiftyone Dia. 31.8 mm

Ground Fiftyone Dia. 31.8 mm
0/700 mm (XS) 0/720 mm (S) 0/740 mm (M-L) 0/760 (XL)

Shimano CUES RD-U3020 9-S

Shimano CUES FD-U4000

Shimano CUES SL-U4010

Shimano CUES FC-U4000 36-22

Shimano CUES CS-LG300-9 11-36

Tektro HD-M275 180 mm

GHOST SP DC1 31.6 mm

Selle Italia MODEL X Superflow

14106

BB-Thun

FRHG0004

MTB Grip

Mitas Ocelot 29x2.35 //
Mitas Ocelot 29x2.35

Rodi Excalibur XC 19 //
Rodi Excalibur XC 19

Shimano HB-TX505 QR 100 mm

Shimano FH-TX505 QR 135 mm

GRÖSSE	ARTIKELNUMMER	LAUFRADGRÖSSE
S	93KA1084	29
M	93KA1085	29
L	93KA1086	29
XL	93KA1087	29



GRÖSSE	ARTIKELNUMMER	LAUFRADGRÖSSE
XS	93KA1020	27.5
S	93KA1021	27.5
M	93KA1022	27.5



light grey / black - matt



KATO ESSENTIAL

KATO AL	Shimano FC-TY301 42-34-24	FRHG0004
RST Blaze 100 mm	Shimano CS-HG-200-8 12-32	MTB Grip
Ground Fiftyone Dia. 31.8 mm	Tektro HD-M275 180 mm	Mitas Ocelot 29x2.35 // Mitas Ocelot 29x2.35
Ground Fiftyone Dia. 31.8 mm 0/700 mm (XS) 0/720 mm (S) 0/740 mm (M-L) 0/760 (XL)	GHOST SP DC1 31.6 mm	Rodi Excalibur XC 19 // Rodi Excalibur XC 19
Shimano Acera RD-M3020 8-S	Selle Italia Model X Superflow	Shimano HB-TX505 QR 100 mm
Shimano Tourney FD-TY700-TS6	14106	Shimano FH-TX505 QR 135 mm
Shimano Altus SL-M315	BB-Thun	

GRÖSSE	ARTIKELNUMMER	LAUFRADGRÖSSE
S	93KA1072	29
M	93KA1073	29
L	93KA1074	29
XL	93KA1075	29



GRÖSSE	ARTIKELNUMMER	LAUFRADGRÖSSE
XS	93KA1010	27.5
S	93KA1011	27.5
M	93KA1012	27.5



baby blue pearl / dark orange - glossy



KATO ESSENTIAL

KATO AL

RST Blaze 100 mm

Ground Fiftyone Dia. 31.8 mm

Ground Fiftyone Dia. 31.8 mm
0/700 mm (XS) 0/720 mm (S) 0/740 mm (M-L) 0/760 (XL)

Shimano Acera RD-M3020 8-S

Shimano Tourney FD-TY700-TS6

Shimano Altus SL-M315

Shimano FC-TY301 42-34-24

Shimano CS-HG-200-8 12-32

Tektro HD-M275 180 mm

GHOST SP DC1 31.6 mm

Selle Italia Model X Superflow

14106

BB-Thun

FRHG0004

MTB Grip

Mitas Ocelot 29x2.35 //
Mitas Ocelot 29x2.35

Rodi Excalibur XC 19 //
Rodi Excalibur XC 19

Shimano HB-TX505 QR 100 mm

Shimano FH-TX505 QR 135 mm

GRÖSSE	ARTIKELNUMMER	LAUFRADGRÖSSE
S	93KA1077	29
M	93KA1078	29
L	93KA1079	29
XL	93KA1080	29



GRÖSSE	ARTIKELNUMMER	LAUFRADGRÖSSE
XS	93KA1014	27.5
S	93KA1015	27.5
M	93KA1016	27.5



black / riot red - glossy



KATO

KATO AL

SR Suntour XCE28 DS 100 mm

Ground Fiftyone Dia. 31.8 mm

Ground Fiftyone Dia. 31.8 mm
0/700 mm (XS) 0/720 mm (S) 0/740 mm (M-L) 0/760 (XL)

Shimano Tourney RD-TY300 7-S

Shimano Tourney FD-TY300

Shimano ST-EF505

Shimano FC-TY301 42-34-24

Shimano CS-HG-200-7 12-32

Shimano BR-MT200 160 mm Disc

GHOST SP DC1 31.6 mm

Selle Italia Model X Superflow

14106

BB-Thun

FRHG0004

MTB Grip

Mitas Ocelot 29x2.10 //
Mitas Ocelot 29x2.10

Schürmann Yak Disc 25 //
Schürmann Yak Disc 25

Shimano HB-TX505 QR 100 mm

Shimano FH-TX505 QR 135 mm

GRÖSSE	ARTIKELNUMMER	LAUFRADGRÖSSE
S	93KA1060	29
M	93KA1061	29
L	93KA1062	29
XL	93KA1063	29



GRÖSSE	ARTIKELNUMMER	LAUFRADGRÖSSE
XS	93KA1000	27.5
S	93KA1001	27.5
M	93KA1002	27.5



light mint pearl / black - matt



KATO

- KATO AL
- SR Suntour XCE28 DS 100 mm
- Ground Fiftyone Dia. 31.8 mm
- Ground Fiftyone Dia. 31.8 mm
0/700 mm (XS) 0/720 mm (S) 0/740 mm (M-L) 0/760 (XL)
- Shimano Tourney RD-TY300 7-S
- Shimano Tourney FD-TY300
- Shimano ST-EF505

- Shimano FC-TY301 42-34-24
- Shimano CS-HG-200-7 12-32
- Shimano BR-MT200 160 mm Disc
- GHOST SP DC1 31.6 mm
- Selle Italia Model X Superflow
- 14106
- BB-Thun

- FRHG0004
- MTB Grip
- Mitas Ocelot 29x2.10 //
Mitas Ocelot 29x2.10
- Schürmann Yak Disc 25 //
Schürmann Yak Disc 25
- Shimano HB-TX505 QR 100 mm
- Shimano FH-TX505 QR 135 mm

GRÖSSE	ARTIKELNUMMER	LAUFRADGRÖSSE
S	93KA1065	29
M	93KA1066	29
L	93KA1067	29
XL	93KA1068	29



GRÖSSE	ARTIKELNUMMER	LAUFRADGRÖSSE
XS	93KA1004	27.5
S	93KA1005	27.5
M	93KA1006	27.5





BIKES

ASKET

RIOT

LECTOR

NIRVANA

KATO

LANAO

YOUTH

KIDS

SQUARE

beige metallic / dark blue pearl - matt



LANAO PRO

📏 LANAO AL

🏠 Rock Shox Judy TK R 100 mm

🔧 Ground Fiftyone Dia. 31.8 mm

📏 Ground Fiftyone Dia. 31.8 mm
0/700 mm (XS) 0/720 mm (S) 0/740 mm (M)

🔧 Shimano Deore RD-M6100 12-S

🔧 Shimano Deore SL-M6100

🔧 Shimano FC-MT510 32T

🔧 Shimano Deore CS-M6100 10-51

🔧 Shimano BR-MT200 180 mm Disc

🔧 GHOST SP DC1 31.6 mm

🏠 Selle Italia Model X Superflow

🔧 14106

🔧 Shimano BB52 BSA

🔧 FRHG0004

🔧 MTB Grip

🔧 Schwalbe Smart Sam 27.5x2.25 //
Schwalbe Smart Sam 27.5x2.25

🔧 Rodi Excalibur XC 19 //
Rodi Excalibur XC 19

🔧 Shimano HB-TX505 QR 100 mm

🔧 Shimano FH-MT401 QR 135 mm







GRÖSSE	ARTIKELNUMMER	LAUFRADGRÖSSE
XS	93LA1024	27.5
S	93LA1025	27.5
M	93LA1026	27.5













black / pearl purple - matt



LANA0 ADVANCED

-  LANA0 AL
-  SR Suntour XCR RL-R AIR 100 mm
-  Ground Fiftyone Dia. 31.8 mm
-  Ground Fiftyone Dia. 31.8 mm
0/700 mm (XS) 0/720 mm (S) 0/740 mm (M)
-  Shimano CUES RD-U6020 10-S
-  Shimano CUES FD-U6000-M
-  Shimano CUES SL-U6000-10

-  Shimano CUES FC-U6000-2 36-22T
-  Shimano CUES CS-LG300-10 11-39
-  Shimano BR-MT200 180 mm Disc
-  GHOST SP DC1 31.6 mm
-  Selle Italia MODEL X Superflow
-  14106
-  Shimano BB52 BSA

-  FRHG0004
-  MTB Grip
-  Schwalbe Smart Sam 27.5x2.25 //
Schwalbe Smart Sam 27.5x2.25
-  Rodi Excalibur XC 19 //
Rodi Excalibur XC 19
-  Shimano HB-TX505 QR 100 mm
-  Shimano FH-TX505 QR 135 mm

GRÖSSE	ARTIKELNUMMER	LAUFRADGRÖSSE
XS	93LA1018	27.5
S	93LA1019	27.5
M	93LA1020	27.5



light mint pearl / azur blue metallic - matt



LANAO UNIVERSAL

LANA0 AL

Rock Shox Judy TK R 100 mm

Ground Fiftyone Dia. 31.8 mm

Ground Fiftyone Dia. 31.8 mm
0/700 mm (XS) 0/720 mm (S) 0/740 mm (M)

Shimano CUES RD-U3020 9-S

Shimano CUES FD-U4000

Shimano CUES SL-U4010

Shimano CUES FC-U4000 36-22

Shimano CUES CS-LG300-9 11-36

Tektro HD-M275 180 mm

GHOST SP DC1 31.6 mm

Selle Italia MODEL X Superflow

14106

BB-Thun

FRHG0004

MTB Grip

Mitas Ocelot 27x2.35 //
Mitas Ocelot 27x2.35

Rodi Excalibur XC 19 //
Rodi Excalibur XC 19

Shimano HB-TX505 QR 100 mm

Shimano FH-TX505 QR 135 mm

GRÖSSE	ARTIKELNUMMER	LAUFRADGRÖSSE
XS	93LA1012	
S	93LA1013	
M	93LA1014	





pearl white / green bay metallic - glossy / matt



LANAO ESSENTIAL

LANAO AL

RST Blaze 100 mm

Ground Fiftyone Dia. 31.8 mm

Ground Fiftyone Dia. 31.8 mm
Ø/700 mm (XS) Ø/720 mm (S) Ø/740 mm (M)

Shimano Acera RD-M3020 8-S

Shimano Tourney FD-TY700-TS6

Shimano Altus SL-M315

Shimano FC-TY301 42-34-24

Shimano CS-HG-200-8 12-32

Tektro HD-M275 180 mm

GHOST SP DC1 31.6 mm

Selle Italia Model X Superflow

14106

BB-Thun

FRHG0004

MTB Grip

Mitas Ocelot 27x2.35 //
Mitas Ocelot 27x2.35

Rodi Excalibur XC 19 //
Rodi Excalibur XC 19

Shimano HB-TX505 QR 100 mm

Shimano FH-TX505 QR 135 mm

GRÖSSE	ARTIKELNUMMER	LAUFRADGRÖSSE
XS	93LA1006	
S	93LA1007	
M	93LA1008	



light mint pearl / purple pearl - glossy



LANAO

LANAO AL

SR Suntour XCE28 DS 100 mm

Ground Fiftyone Dia. 31.8 mm

Ground Fiftyone Dia. 31.8 mm
0/700 mm (XS) 0/720 mm (S) 0/740 mm (M)

Shimano Tourney RD-TY300 7-S

Shimano Tourney FD-TY300

Shimano ST-EF505

Shimano FC-TY301 42-34-24

Shimano CS-HG-200-7 12-32

Shimano BR-MT200 160 mm Disc

GHOST SP DC1 31.6 mm

Selle Italia Model X Superflow

14106

BB-Thun

FRHG0004

MTB Grip

Mitas Ocelot 27x2.10 //
Mitas Ocelot 27x2.10

Schürmann Yak Disc 25 //
Schürmann Yak Disc 25

Shimano HB-TX505 QR 100 mm

Shimano FH-TX505 QR 135 mm

GRÖSSE	ARTIKELNUMMER	LAUFRADGRÖSSE
XS	93LA1000	27.5
S	93LA1001	27.5
M	93LA1002	27.5





deep red pearl / purple pearl - glossy



LANAQ EQ

LANAQ AL	Shimano CS-HG-200-8 12-32	Mitas Ocelot 27x2.35 // Mitas Ocelot 27x2.35
RST Blaze 100 mm	Tektro HD-M275 180 mm	Schürmann Yak Disc 25 // Schürmann Yak Disc 25
Ground Fiftyone Dia. 31.8 mm	GHOST SP DC1 31.6 mm	Shimano HB-TX505 QR 100 mm
Ground Fiftyone Dia. 31.8 mm 0/700 mm (XS) 0/720 mm (S) 0/740 mm (M)	Selle Italia Model X Superflow	Shimano FH-MT401 QR 135 mm
Shimano Acera RD-M3020 8-S	14106	SKS Veloflexx 65
Shimano FD-TY700-TS6	BB-Thun	Büchel Akku Sport
Shimano Altus SL-M315	FRHG0004	Büchel Tivoli
Shimano FC-TY301 42-34-24	MTB Grip	

GRÖSSE	ARTIKELNUMMER	LAUFRADGRÖSSE
XS	93LA1030	
S	93LA1031	
M	93LA1032	



poseidon blue pearl / green - matt



LANAQ EQ

LANAQ AL

RST Blaze 100 mm

Ground Fiftyone Dia. 31.8 mm

Ground Fiftyone Dia. 31.8 mm
0/700 mm (XS) 0/720 mm (S) 0/740 mm (M)

Shimano Acera RD-M3020 8-S

Shimano FD-TY700-TS6

Shimano Altus SL-M315

Shimano FC-TY301 42-34-24

Shimano CS-HG-200-8 12-32

Tektro HD-M275 180 mm

GHOST SP DC1 31.6 mm

Selle Italia Model X Superflow

14106

BB-Thun

FRHG0004

MTB Grip

Mitas Ocelot 27x2.35 //
Mitas Ocelot 27x2.35

Schürmann Yak Disc 25 //
Schürmann Yak Disc 25

Shimano HB-TX505 QR 100 mm

Shimano FH-MT401 QR 135 mm

SKS Veloflexx 65

Büchel Akku Sport

Büchel Tivoli

GRÖSSE	ARTIKELNUMMER	LAUFRADGRÖSSE
XS	93LA1034	27.5
S	93LA1035	27.5
M	93LA1036	27.5





BIKES



ASKET

RIOT

LECTOR

NIRVANA

KATO

LANAO

YOUTH

KIDS

SQUARE

grey purple / black matt

SUPER FIT
by GHOST



RIOT YOUTH PRO

RIOT Youth Pro

SR Suntour XCR34 Air 130mm

SR Suntour Raidon R 130 mm

Ground Fiftyone Dia. 31.8 mm

Ground Fiftyone Dia. 31.8 mm 0/700 mm

SRAM GX Eagle 12-S

SRAM SX Eagle

Truvativ Stylo 6K 32T

SRAM PG-1230 11-50

Shimano BR-MT410 180 mm Disc

Limotec Alpha 31.6 mm Travel 125mm

Selle Italia Model X Superflow

Strummer semi-integrated

SRAM Power Spline 118/73

FRHG0061

MTB Grip

WTB Ranger 2.3 Comp //
WTB Ranger 2.3 Comp

WTB ST i30 //
WTB ST i30

Shimano HB-MT400-B 15x110 mm

Shimano FH-MT410-B 12x148 mm

GRÖSSE ARTIKELNUMMER LAUFRADGRÖSSE

XS

93KA2025

27.5





bright blue / black - glossy



KATO YOUTH

KATO YOUTH AL

SR Suntour XCE28 DS 100 mm

Ground Fiftyone Dia. 31.8 mm

Ground Fiftyone Dia. 31.8 mm 700/0

Shimano Tourney RD-TY300 7-S

Shimano Tourney FD-TY300

Shimano ST-EF505

Shimano FC-TY301 42-34-24

Shimano CS-HG-200-7 12-32

Shimano BR-MT200 160 mm Disc

Ghost 31.6 mm

Selle Italia Model X Superflow

Strummer semi-integrated

Shimano BB-UN101

FRHG0004

MTB Grip

Mitas Ocelot 2.10
Mitas Ocelot 2.10

Schürmann Yak Disc 25
Schürmann Yak Disc 25

Shimano HB-TX505 QR 100 mm

Shimano FH-TX505 QR 135 mm

GRÖSSE ARTIKELNUMMER LAUFRADGRÖSSE

XXS

31KA1200

27.5



bright blue / black - glossy



KATO YOUTH EQ

KATO YOUTH AL	Shimano CS-HG-200-8 12-32	Mitas Ocelot 2.10 Mitas Ocelot 2.10
SR Suntour XCE28 DS 100 mm	Tektro HD-M275 180 mm Disc	Schürmann Yak Disc 25 Schürmann Yak Disc 25
Ground Fiftyone Dia. 31.8 mm	Ghost 31.6 mm	XLC Carrier
Ground Fiftyone Dia. 31.8 mm 700/0	Selle Italia Model X Superflow	XLC Fender
Shimano Acera RD-M3020 8-S	Strummer semi-integrated	Büchel Akku Sport
Shimano Tourney FD-TY700-TS6	Shimano BB-UN101	Büchel Tivolo
Shimano SL-M315	FRHG0004	
Shimano FC-TY301 42-34-24	MTB Grip	

GRÖSSE ARTIKELNUMMER LAUFRADGRÖSSE

XXS

31KA1203

27.5



pearl white crystal / blue green - glossy



LANAO YOUTH

LANAO YOUTH AL

SR Suntour XCE28 DS 100 mm

Ground Fiftyone Dia. 31.8 mm

Ground Fiftyone Dia. 31.8 mm 700/0

Shimano Tourney RD-TY300 7-S

Shimano Tourney FD-TY300

Shimano ST-EF505

Shimano FC-TY301 42-34-24

Shimano CS-HG-200-7 12-32

Shimano BR-MT200 160 mm Disc

Ghost 31.6 mm

Selle Italia Model X Superflow

Strummer semi-integrated

Shimano BB-UN101

FRHG0004

MTB Grip

Mitas Ocelot 2.10
Mitas Ocelot 2.10

Schürmann Yak Disc 25
Schürmann Yak Disc 25

Shimano HB-TX505 QR 100 mm

Shimano FH-TX505 QR 135 mm

GRÖSSE ARTIKELNUMMER LAUFRADGRÖSSE

XXS

31LA1035

27.5



pearl white crystal / blue green - glossy



LANAO YOUTH EQ

LANAO YOUTH AL

SR Suntour XCE28 DS 100 mm

Ground Fiftyone Dia. 31.8 mm

Ground Fiftyone Dia. 31.8 mm 700/0

Shimano Acera RD-M3020 8-S

Shimano Tourney FD-TY700-TS6

Shimano SL-M315

Shimano FC-TY301 42-34-24

Shimano CS-HG-200-8 12-32

Tektro HD-M275 180 mm Disc

Ghost 31.6 mm

Selle Italia Model X Superflow

Strummer semi-integrated

Shimano BB-UN101

FRHG0004

MTB Grip

Mitas Ocelot 2.10
Mitas Ocelot 2.10

Schürmann Yak Disc 25
Schürmann Yak Disc 25

XLC Carrier

XLC Fender

Büchel Akku Sport

Büchel Tivolo

GRÖSSE ARTIKELNUMMER LAUFRADGRÖSSE

XXS

31LA1038

27.5





BIKES



ASKET

RIOT

LECTOR

NIRVANA

KATO

LANAO

YOUTH

KIDS

SQUARE



pearl white / bright blue - glossy



SUPER FIT
by GHOST



KATO 24 FULL PARTY

 KATO Kid AL

 SR Suntour XCR Air LO 80 mm

 GHOST 28.6 mm

 GHOST Junior 560 mm 25 mm Rise

 Shimano Deore RD-M5100 11-S

 Shimano Deore SL-M5100

 Samox 30T

 Shimano Deore CS-M5100 11-42

 Tektro HD-M276 Hydraulic Disc

 GHOST SP DC1 27.2 mm

 DDK 922

 FSA

 Velo VLG 1979-D

 Schwalbe Smart Sam 2.35 //
Schwalbe Smart Sam 2.35

 Shining DB-X30 //
Shining DB-X30

 KT-TC7F QR

 KT-TC7R QR

 FRHG0064

GRÖSSE ARTIKELNUMMER LAUFRADGRÖSSE

24

93KA1306

24



silver chrom / dark silver chrom - glossy

SUPER FIT
by *GHOST*



KATO 24 FULL PARTY

 KATO Kid AL

 SR Suntour XCR Air LO 80 mm

 GHOST 28.6 mm

 GHOST Junior 560 mm 25 mm Rise

 Shimano Deore RD-M5100 11-S

 Shimano Deore SL-M5100

 Samox 30T

 Shimano Deore CS-M5100 11-42

 Tektro HD-M276 Hydraulic Disc

 GHOST SP DC1 27.2 mm

 DDK 922

 FSA

 Velo VLG 1979-D

 Schwalbe Smart Sam 2.35 //
Schwalbe Smart Sam 2.35

 Shining DB-X30 //
Shining DB-X30

 KT-TC7F QR

 KT-TC7R QR

 FRHG0064

GRÖSSE ARTIKELNUMMER LAUFRADGRÖSSE

24

93KA1305

24



rainbow silver / riot red - glossy

SUPER FIT
by GHOST



KATO 24 PRO

 KATO Kid AL

 RST Capa T 50 mm

 GHOST AS-GH2 31.8 mm

 GHOST Junior 560 mm 25 mm Rise

 Shimano Deore RD-M6000 10-S

 Shimano Deore SL-M4100

 Samox 28T

 Shimano Deore CS-M4100 11-42

 Tektro HD-M276 Hydraulic Disc

 GHOST SP DC1 27.2 mm

 DDK 922

 FSA

 Velo VLG 1979-D

 Schwalbe Smart Sam 2.35 //
Schwalbe Smart Sam 2.35

 Shining DB-X30 //
Shining DB-X30

 KT-T04F QR

 KT-MR5R QR

 FRHG0064

GRÖSSE ARTIKELNUMMER LAUFRADGRÖSSE

24

93KA1300

24





candy lime green / black - glossy



SUPER FIT
by GHOST



KATO 24 PRO

 KATO Kid AL

 RST Capa T 50 mm

 GHOST AS-GH2 31.8 mm

 GHOST Junior 560 mm 25 mm Rise

 Shimano Deore RD-M6000 10-S

 Shimano Deore SL-M4100

 Samox 28T

 Shimano Deore CS-M4100 11-42

 Tektro HD-M276 Hydraulic Disc

 GHOST SP DC1 27.2 mm

 DDK 922

 FSA

 Velo VLG 1979-D

 Schwalbe Smart Sam 2.35 //
Schwalbe Smart Sam 2.35

 Shining DB-X30 //
Shining DB-X30

 KT-T04F QR

 KT-MR5R QR

 FRHG0064

GRÖSSE ARTIKELNUMMER LAUFRADGRÖSSE

24

93KA1301

24



rainbow silver / riot red - glossy

SUPER FIT
by GHOST



KATO 24 PRO EQ

KATO Kid AL

Ghost Rigid

GHOST TDS-C614N

GHOST Junior 560 mm 25 mm Rise

Shimano Deore RD-M6000 10-S

Shimano Deore SL-M4100

Samox 28T

Shimano Deore CS-M4100 11-42

Tektro HD-M276 Hydraulic Disc

GHOSH SP DC1 27.2 mm

DDK 922

FSA

Velo VLG 1979-D

Schwalbe Smart Sam 2.35 //
Schwalbe Smart Sam 2.35

Shining DB-X30 //
Shining DB-X30

KT-T04F QR

KT-MR5R QR

Unikey 24" Carrier

Sunnywheel SW-825FR

Nuvo Adjustable 20-28"

Spanninga X&O 25

Spanninga Solo XB

FRHG0064

GRÖSSE ARTIKELNUMMER LAUFRADGRÖSSE

24

93KA1303

24





Dirty blue / metallic lime - glossy



SUPER FIT
by GHOST



KATO 20 FULL PARTY

 KATO Kid AL

 GHOST Suspension

 GHOST 28.6 mm

 GHOST Junior 540 mm 25 mm Rise

 Shimano Deore RD-M6000 10-S

 Shimano Deore SL-M4100

 Samox 28T

 Shimano Deore CS-M4100 11-42

 Tektro HD-M276 Hydraulic Disc

 GHOST SP DC1 27.2 mm

 GHOST VL 5062

 FSA

 Velo VLG 1979-D

 Schwalbe Smart Sam 2.35 //
Schwalbe Smart Sam 2.35

 Shining DB-X30 //
Shining DB-X30

 KT-T04F QR

 KT-MR5R QR

 FRHG0064

GRÖSSE ARTIKELNUMMER LAUFRADGRÖSSE

20

93KA1203

20





pearl white / bright blue - glossy



SUPER FIT
by GHOST



KATO 20 FULL PARTY

 KATO Kid AL

 GHOST Suspension

 GHOST 28.6 mm

 GHOST Junior 540 mm 25 mm Rise

 Shimano Deore RD-M6000 10-S

 Shimano Deore SL-M4100

 Samox 28T

 Shimano Deore CS-M4100 11-42

 Tektro HD-M276 Hydraulic Disc

 GHOST SP DC1 27.2 mm

 GHOST VL 5062

 FSA

 Velo VLG 1979-D

 Schwalbe Smart Sam 2.35 //
Schwalbe Smart Sam 2.35

 Shining DB-X30 //
Shining DB-X30

 KT-T04F QR

 KT-MR5R QR

 FRHG0064

GRÖSSE ARTIKELNUMMER LAUFRADGRÖSSE

20

93KA1204

20



Black / Ocean candy - glossy

SUPER FIT
by *GHOST*



KATO 20 PRO

 KATO Kid AL

 GHOST Rigid

 GHOST AS-601 25.4 mm

 GHOST Junior 540 mm 25 mm Rise

 Shimano Acera RD-M360 8-S

 Shimano Altus SL-M315

 Samox 28T

 Shimano CS-HG31 11-34

 Tektro 837 AL V-Brake

 GHOST SP DC1 27.2 mm

 GHOST VL 5062

 FSA

 Velo VLG 1979-D

 Schwalbe Smart Sam 2.35 //
Schwalbe Smart Sam 2.35

 Shining MT-46 //
Shining MT-46

 KT-A15F QR

 KT-AZER QR

 FRHG0064

GRÖSSE ARTIKELNUMMER LAUFRADGRÖSSE

20

93KA1200

20



green / monarch orange - glossy

SUPER FIT
by GHOST



KATO 20 PRO

KATO Kid AL

GHOST Rigid

GHOST AS-601 25.4 mm

GHOST Junior 540 mm 25 mm Rise

Shimano Acera RD-M360 8-S

Shimano Altus SL-M315

Samox 28T

Shimano CS-HG31 11-34

Tektro 837 AL V-Brake

GHOST SP DC1 27.2 mm

GHOST VL 5062

FSA

Velo VLG 1979-D

Schwalbe Smart Sam 2.35 //
Schwalbe Smart Sam 2.35

Shining MT-46 //
Shining MT-46

KT-A15F QR

KT-AZER QR

FRHG0064

GRÖSSE ARTIKELNUMMER LAUFRADGRÖSSE

20

93KA1201

20



black / fogbow purple - glossy

SUPER FIT
by **GHOST**



LANAO 24 FULL PARTY

LANAO Kid AL

SR Suntour XCR Air LO 80 mm

GHOST 28.6 mm

GHOST Junior 560 mm 25 mm Rise

Shimano Deore RD-M5100 11-S

Shimano Deore SL-M5100

Samox 30T

Shimano Deore CS-M5100 11-42

Tektro HD-M276 Hydraulic Disc

GHOST SP DC1 27.2 mm

DDK 922

FSA

Velo VLG 1979-D

Schwalbe Smart Sam 2.35 //
Schwalbe Smart Sam 2.35

Shining DB-X30 //
Shining DB-X30

KT-TC7F QR

KT-TC7R QR

FRHG0064

GRÖSSE ARTIKELNUMMER LAUFRADGRÖSSE

24

93LA1305

24



sid chrom / candy magenta - glossy

SUPER FIT
by **GHOST**



LANAO 24 FULL PARTY

LANAo Kid AL

SR Suntour XCR Air LO 80 mm

GHOST 28.6 mm

GHOST Junior 560 mm 25 mm Rise

Shimano Deore RD-M5100 11-S

Shimano Deore SL-M5100

Samox 30T

Shimano Deore CS-M5100 11-42

Tektro HD-M276 Hydraulic Disc

GHOST SP DC1 27.2 mm

DDK 922

FSA

Velo VLG 1979-D

Schwalbe Smart Sam 2.35 //
Schwalbe Smart Sam 2.35

Shining DB-X30 //
Shining DB-X30

KT-TC7F QR

KT-TC7R QR

FRHG0064

GRÖSSE ARTIKELNUMMER LAUFRADGRÖSSE

24

93LA1306

24



baby blue / magenta - glossy

SUPER FIT
by GHOST



LANAO 24 PRO

LANAO Kid AL

RST Capa T 50 mm

GHOST AS-GH2 31.8 mm

GHOST Junior 560 mm 25 mm Rise

Shimano Deore RD-M6000 10-S

Shimano Deore SL-M4100

Samox 28T

Shimano Deore CS-M4100 11-42

Tektro HD-M276 Hydraulic Disc

GHOST SP DC1 27.2 mm

DDK 922

FSA

Velo VLG 1979-D

Schwalbe Smart Sam 2.35 //
Schwalbe Smart Sam 2.35

Shining DB-X30 //
Shining DB-X30

KT-T04F QR

KT-MR5R QR

FRHG0064

GRÖSSE ARTIKELNUMMER LAUFRADGRÖSSE

24

93LA1300

24



dazzling green / pearl white - glossy



LANAO 24 PRO

LANAO Kid AL

RST Capa T 50 mm

GHOST AS-GH2 31.8 mm

GHOST Junior 560 mm 25 mm Rise

Shimano Deore RD-M6000 10-S

Shimano Deore SL-M4100

Samox 28T

Shimano Deore CS-M4100 11-42

Tektro HD-M276 Hydraulic Disc

GHOST SP DC1 27.2 mm

DDK 922

FSA

Velo VLG 1979-D

Schwalbe Smart Sam 2.35 //
Schwalbe Smart Sam 2.35

Shining DB-X30 //
Shining DB-X30

KT-T04F QR

KT-MR5R QR

FRHG0064

GRÖSSE ARTIKELNUMMER LAUFRADGRÖSSE

24

93LA1301

24



dazzling green / pearl white - glossy



LANAO 24 PRO EQ

LANAO Kid AL

Ghost Rigid

GHOST TDS-C614N

GHOST Junior 560 mm 25 mm Rise

Shimano Deore RD-M6000 10-S

Shimano Deore SL-M4100

Samox 28T

Shimano Deore CS-M4100 11-42

Tektro HD-M276 Hydraulic Disc

GHOST SP DC1 27.2 mm

DDK 922

FSA

Velo VLG 1979-D

Schwalbe Smart Sam 2.35 //
Schwalbe Smart Sam 2.35

Shining DB-X30 //
Shining DB-X30

KT-T04F QR

KT-MR5R QR

Unikey 24" Carrier

Sunnywheel SW-825FR

Nuvo Adjustable 20-28"

Spanninga X&O 25

Spanninga Solo XB

FRHG0064

GRÖSSE ARTIKELNUMMER LAUFRADGRÖSSE

24

93LA1303

24



metallic black / pink shimmer - glossy

SUPER FIT
by GHOST



LANAO 20 FULL PARTY

LANAO Kid AL

GHOST Suspension

GHOST 28.6 mm

GHOST Junior 540 mm 25 mm Rise

Shimano Deore RD-M6000 10-S

Shimano Deore SL-M4100

Samox 28T

Shimano Deore CS-M4100 11-42

Tektro HD-M276 Hydraulic Disc

GHOST SP DC1 27.2 mm

GHOST VL 5062

FSA

Velo VLG 1979-D

Schwalbe Smart Sam 2.35 //
Schwalbe Smart Sam 2.35

Shining DB-X30 //
Shining DB-X30

KT-T04F QR

KT-MR5R QR

FRHG0064

GRÖSSE ARTIKELNUMMER LAUFRADGRÖSSE

20

93LA1203

20



light mint pearl / fogbow purple - glossy

SUPER FIT
by *GHOST*



LANAO 20 FULL PARTY

 LANAo Kid AL

 GHOST Suspension

 GHOST 28.6 mm

 GHOST Junior 540 mm 25 mm Rise

 Shimano Deore RD-M6000 10-S

 Shimano Deore SL-M4100

 Samox 28T

 Shimano Deore CS-M4100 11-42

 Tektro HD-M276 Hydraulic Disc

 GHOST SP DC1 27.2 mm

 GHOST VL 5062

 FSA

 Velo VLG 1979-D

 Schwalbe Smart Sam 2.35 //
Schwalbe Smart Sam 2.35

 Shining DB-X30 //
Shining DB-X30

 KT-T04F QR

 KT-MR5R QR

 FRHG0064

GRÖSSE ARTIKELNUMMER LAUFRADGRÖSSE

20

93LA1204

20



green goldlit / light mint - glossy

SUPER FIT
by *GHOST*



LANAO 20 PRO

 LANAo Kid AL

 GHOST Rigid

 GHOST AS-601 25.4 mm

 GHOST Junior 540 mm 25 mm Rise

 Shimano Acera RD-M360 8-S

 Shimano Altus SL-M315

 Samox 28T

 Shimano CS-HG31 11-34

 Tektro 837 AL V-Brake

 GHOST SP DC1 27.2 mm

 GHOST VL 5062

 FSA

 Velo VLG 1979-D

 Schwalbe Smart Sam 2.35 //
Schwalbe Smart Sam 2.35

 Shining MT-46 //
Shining MT-46

 KT-A15F QR

 KT-AZER QR

 FRHG0064

GRÖSSE ARTIKELNUMMER LAUFRADGRÖSSE

20

93LA1200

20



light mint / pink shimmer - glossy

SUPER FIT
by *GHOST*



LANAO 20 PRO

 LANAo Kid AL

 GHOST Rigid

 GHOST AS-601 25.4 mm

 GHOST Junior 540 mm 25 mm Rise

 Shimano Acera RD-M360 8-S

 Shimano Altus SL-M315

 Samox 28T

 Shimano CS-HG31 11-34

 Tektro 837 AL V-Brake

 GHOST SP DC1 27.2 mm

 GHOST VL 5062

 FSA

 Velo VLG 1979-D

 Schwalbe Smart Sam 2.35 //
Schwalbe Smart Sam 2.35

 Shining MT-46 //
Shining MT-46

 KT-A15F QR

 KT-AZER QR

 FRHG0064

GRÖSSE ARTIKELNUMMER LAUFRADGRÖSSE

20

93LA1201

20





POWERKID 16

POWERKID AL

GHOST AL 16 Rigid

GHOST POWERKID 25.4 mm

GHOST POWERKID 460 mm

GHOST POWERKID 114 mm

Front: V-Brake, Rear: back pedal brake

GHOST Powerkid 27.2 mm

GHOST Powerkid

GHOST Powerkid

Vee Speedster 16 //
Vee Speedster 16

AL 16 //
AL 16

Joytech/KT

Joytech/KT

Kickstand

GRÖSSE ARTIKELNUMMER LAUFRADGRÖSSE

16

93PK1007

16





POWERKID 16

POWERKID AL

GHOST AL 16 Rigid

GHOST POWERKID 25.4 mm

GHOST POWERKID 460 mm

GHOST POWERKID 114 mm

Front: V-Brake, Rear: back pedal brake

GHOST Powerkid 27.2 mm

GHOST Powerkid

GHOST Powerkid

Vee Speedster 16 //
Vee Speedster 16

AL 16 //
AL 16

Joytech/KT

Joytech/KT

Kickstand

GRÖSSE ARTIKELNUMMER LAUFRADGRÖSSE

16

93PK1008

16





POWERKID 12

POWERKID AL

GHOST AL 12 Rigid

GHOST POWERKID 25.4 mm

GHOST POWERKID 460 mm

GHOST POWERKID 89 mm

Front: V-Brake, Rear: back pedal brake

GHOST Powerkid 27.2 mm

GHOST Powerkid

GHOST Powerkid

Vee Speedster 12 //
Vee Speedster 12

AL 12 //
AL 12

Joytech/KT

Joytech/KT

GRÖSSE ARTIKELNUMMER LAUFRADGRÖSSE

12

93PK1005

12





POWERKID 12

POWERKID AL

GHOST AL 12 Rigid

GHOST POWERKID 25.4 mm

GHOST POWERKID 460 mm

GHOST POWERKID 89 mm

Front: V-Brake, Rear: back pedal brake

GHOST Powerkid 27.2 mm

GHOST Powerkid

GHOST Powerkid

Vee Speedster 12 //
Vee Speedster 12

AL 12 //
AL 12

Joytech/KT

Joytech/KT

GRÖSSE ARTIKELNUMMER LAUFRADGRÖSSE

12

93PK1006

12





POWERKIDDY 12

 POWERKIDDY AL

 GHOST AL 12 Rigid

 GHOST POWERKIDDY

 GHOST POWERKIDDY

 GHOST Powerkiddy 27.2 mm

 GHOST Powerkiddy

 GHOST Powerkiddy

 Vee Speedster 12 //
Vee Speedster 12

 AL 12 //
AL 12

 Joytech/KT

 Joytech/KT

GRÖSSE ARTIKELNUMMER LAUFRADGRÖSSE

12

93PK1001

12





POWERKIDDY 12

 POWERKIDDY AL

 GHOST AL 12 Rigid

 GHOST POWERKIDDY

 GHOST POWERKIDDY

 GHOST Powerkiddy 27.2 mm

 GHOST Powerkiddy

 GHOST Powerkiddy

 Vee Speedster 12 //
Vee Speedster 12

 AL 12 //
AL 12

 Joytech/KT

 Joytech/KT

GRÖSSE ARTIKELNUMMER LAUFRADGRÖSSE

12

93PK1003

12





BIKES



ASKET

RIOT

LECTOR

NIRVANA

KATO

LANAO

YOUTH

KIDS

SQUARE

met. black / urban grey - matt



SQUARE TREKKING ESSENTIAL

SQUARE TREKKING AL

SR Suntour NEX HLO DS 63 mm

Ghost Dia. 31.8 mm

GHOST Dia. 31.8 mm 680 mm

Shimano CUES RD-U4020 9-S

Shimano CUES FD-U4010

Shimano CUES SL-U4010

Shimano CUES FC-U4010 46-30

Shimano CUES CS-LG300-9 11-36

Shimano BR-MT200 160 mm Disc

GHOST SP DC1 31.6 mm

Justek 3050 HRN

Strummer semi-integrated

Shimano BB-ES300

Velo VLG-1752D2

Schwalbe Energizer Activ Plus 37-622 //
Schwalbe Energizer Activ Plus 37-622

Rodi Excalibur XC19 //
Rodi Excalibur XC19

Shimano DH-3D37-QR Hyb Dynamo

Shimano FH-QC400-HM QR

Carrier

Pletscher RG40

Ursus Easy Center

Herrmans MR GO

Herrmans H-Trace

FRHG0004

GRÖSSE	ARTIKELNUMMER	LAUFRADGRÖSSE
S	31ST1013	28
M	31ST1014	28
L	31ST1015	28
XL	31ST1016	28



met. black / urban grey - matt



SQUARE TREKKING ESSENTIAL MID

SQUARE TREKKING AL

SR Suntour NEX HLO DS 63 mm

Ghost Dia. 31.8 mm

GHOST Dia. 31.8 mm 680 mm

Shimano CUES RD-U4020 9-S

Shimano CUES FD-U4010

Shimano CUES SL-U4010

Shimano CUES FC-U4010 46-30

Shimano CUES CS-LG300-9 11-36

Shimano BR-MT200 160 mm Disc

GHOST SP DC1 31.6 mm

Justek 3050 HRN

Strummer semi-integrated

Shimano BB-ES300

Velo VLG-1752D2

Schwalbe Energizer Activ Plus 37-622 //
Schwalbe Energizer Activ Plus 37-622

Rodi Excalibur XC19 //
Rodi Excalibur XC19

Shimano DH-3037-QR Hyb Dynamo

Shimano FH-QC400-HM QR

Carrier

Pletscher RG40

Ursus Easy Center

Herrmans MR GO

Herrmans H-Trace

FRHG0004

GRÖSSE	ARTIKELNUMMER	LAUFRADGRÖSSE
XS	31ST1019	28
S	31ST1020	28
M	31ST1021	28
L	31ST1022	28



light grey / warm grey - matt



SQUARE TREKKING

SQUARE TREKKING AL

SR Suntour NEX DS 63 mm

Ghost Dia. 31.8 mm

GHOST Dia. 31.8 mm 680 mm

Shimano Acera RD-M3020 8-S

Shimano SL-M315

Shimano FC-TY301 48-38-28

Shimano CS-HG31 11-34

Shimano BR-MT200 160 mm Disc

GHOST SP DC1 31.6 mm

Justek 3050 HRN

Strummer semi-integrated

Thun Jive 3.0 FS

Velo VLG-1752D2

Schwalbe Energizer Activ Plus 37-622 //
Schwalbe Energizer Activ Plus 37-622

Rodi Excalibur XC19 //
Rodi Excalibur XC19

Shimano DH-3D37-QR Hyb Dynamo

Shimano FH-TX505 QR 135 mm

Carrier

Pletscher RG40

Ursus Easy Center

Herrmans MR GO

Herrmans H-Trace

FRHG0004

GRÖSSE	ARTIKELNUMMER	LAUFRADGRÖSSE
S	31ST1001	28
M	31ST1002	28
L	31ST1003	28
XL	31ST1004	28



light grey / warm grey - matt



SQUARE TREKKING MID

SQUARE TREKKING AL	Shimano BR-MT200 160 mm Disc	Shimano DH-3D37-QR Hyb Dynamo
SR Suntour NEX DS 63 mm	GHOST SP DC1 31.6 mm	Shimano FH-TX505 QR 135 mm
Ghost Dia. 31.8 mm	Justek 3050 HRN	Carrier
GHOST Dia. 31.8 mm 680 mm	Strummer semi-integrated	Pletscher RG40
Shimano Acera RD-M3020 8-S	Thun Jive 3.0 FS	Ursus Easy Center
Shimano SL-M315	Velo VLG-1752D2	Herrmans MR GO
Shimano FC-TY301 48-38-28	Schwalbe Energizer Activ Plus 37-622 // Schwalbe Energizer Activ Plus 37-622	Herrmans H-Trace
Shimano CS-HG31 11-34	Rodi Excalibur XC19 // Rodi Excalibur XC19	FRHG0004

GRÖSSE	ARTIKELNUMMER	LAUFRADGRÖSSE
XS	31ST1007	28
S	31ST1008	28
M	31ST1009	28
L	31ST1010	28



blue grey / dirty blue - matt



SQUARE CROSS ESSENTIAL

SQUARE CROSS AL

Rock Shox Paragon Gold RL 65 mm

Ghost Dia. 31.8 mm

GHOST Dia. 31.8 mm 680 mm

SRAM SX Eagle 12-S

SRAM SX Eagle

SRAM FC S650 38T

SRAM PG-1210 11-50

Shimano BR-MT200 160 mm Disc

GHOST SP DC1 31.6 mm

Justek 3050 HRN

Strummer semi-integrated

SRAM Powerspline

Velo VLG-175102

Schwalbe Smart Sam Performance 47-622 //
Schwalbe Smart Sam Performance 47-622

Rodi Excalibur XC19 //
Rodi Excalibur XC19

Shimano HB-TX505 QR 100 mm

Shimano FH-TX505 QR 135 mm

FRHG0004

GRÖSSE	ARTIKELNUMMER	LAUFRADGRÖSSE
S	31SC1013	28
M	31SC1014	28
L	31SC1015	28
XL	31SC1016	28



blue grey / dirty blue - matt



SQUARE CROSS ESSENTIAL MID

SQUARE CROSS AL

Rock Shox Paragon Gold RL 65 mm

Ghost Dia. 31.8 mm

GHOST Dia. 31.8 mm 680 mm

SRAM SX Eagle 12-S

SRAM SX Eagle

SRAM FC S650 38T

SRAM PG-1210 11-50

Shimano BR-MT200 160 mm Disc

GHOST SP DC1 31.6 mm

Justek 3050 HRN

Strummer semi-integrated

SRAM Powerspline

Velo VLG-175102

Schwalbe Smart Sam Performance 47-622 //
Schwalbe Smart Sam Performance 47-622

Rodi Excalibur XC19 //
Rodi Excalibur XC19

Shimano HB-TX505 QR 100 mm

Shimano FH-TX505 QR 135 mm

FRHG0004

GRÖSSE	ARTIKELNUMMER	LAUFRADGRÖSSE
XS	31SC1019	28
S	31SC1020	28
M	31SC1021	28
L	31SC1022	28



light grey / dark grey - matt



SQUARE CROSS

SQUARE CROSS AL

SR Suntour NEX DS 63 mm

Ghost Dia. 31.8 mm

GHOST Dia. 31.8 mm 680 mm

Shimano CUES RD-U4020 9-S

Shimano CUES FD-U4010

Shimano CUES SL-U4010

Shimano CUES FC-U4010 46-30

Shimano CUES CS-LG300-9 11-36

Shimano BR-MT200 160 mm Disc

GHOST SP DC1 31.6 mm

Justek 3050 HRN

Strummer semi-integrated

Prestine PT-6621

Velo VLG-1751D2

Schwalbe Smart Sam Performance 47-622 //
Schwalbe Smart Sam Performance 47-622

Rodi Excalibur XC19 //
Rodi Excalibur XC19

Shimano HB-QC400 QR

Shimano FH-QC400-HM QR

FRHG0004

GRÖSSE	ARTIKELNUMMER	LAUFRADGRÖSSE
S	31SC1001	28
M	31SC1002	28
L	31SC1003	28
XL	31SC1004	28



light grey / dark grey - matt



SQUARE CROSS MID

SQUARE CROSS AL

SR Suntour NEX DS 63 mm

Ghost Dia. 31.8 mm

GHOST Dia. 31.8 mm 680 mm

Shimano CUES RD-U4020 9-S

Shimano CUES FD-U4010

Shimano CUES SL-U4010

Shimano CUES FC-U4010 46-30

Shimano CUES CS-LG300-9 11-36

Shimano BR-MT200 160 mm Disc

GHOST SP DC1 31.6 mm

Justek 3050 HRN

Strummer semi-integrated

Prestine PT-6621

Velo VLG-1751D2

Schwalbe Smart Sam Performance 47-622 //
Schwalbe Smart Sam Performance 47-622

Rodi Excalibur XC19 //
Rodi Excalibur XC19

Shimano HB-QC400 QR

Shimano FH-QC400-HM QR

FRHG0004

GRÖSSE	ARTIKELNUMMER	LAUFRADGRÖSSE
XS	31SC1007	28
S	31SC1008	28
M	31SC1009	28
L	31SC1010	28





P&A

| BIKEPARTS

BOSCH MOTORS

BOSCH



85 Nm
TORQUE



85 Nm
TORQUE



BOSCH PERFORMANCE CX-R

- ▶ mehr Unterstützung mit bis zu 400 %
- ▶ spezieller Rennmodus, um so schnell wie möglich zu sein // 85 Nm + Boost
- ▶ Spezialgehäuse mit einzigartiger Farbgebung
- ▶ geringeres Gewicht durch optimiertes Leichtbaugeschäfte und Leichtbauwellen (2,75 kg)

- ▶ *more support, up to 400 %*
- ▶ *special race mode to be as fast as possible // 85Nm + ExtraBoost*
- ▶ *special housing/logo with unique colouring*
- ▶ *low weight due to optimised lightweight housing and shaft (2,75 kg)*

BOSCH PERFORMANCE CX

- ▶ kompakt und dabei extrem leistungsstark und effizient
- ▶ beschleunigt extrem druckvoll
- ▶ reagiert ohne Verzögerung
- ▶ bis zu 340% perfekt dosierte Unterstützung
- ▶ 1,1 kg leichter als der Vorgänger

- ▶ *compact and at the same time extremely powerful and efficient*
- ▶ *accelerates extremely forcefully*
- ▶ *reacts without delay*
- ▶ *up to 340% perfectly dosed support*
- ▶ *1.1 kg lighter than its predecessor*

BOSCH PERFORMANCE CX-R

BOSCH PERFORMANCE CX

GEWICHT/WEIGHT

2,7 kg

2,9 kg

RATED POWER

250 Watt

250 Watt

MAX. TORQUE

85 Nm w/ additional boost

85 Nm

MAX. SUPPORT SPEED

25 km/h

25 km/h

SUPPORT MODE (%)

4 Modi / modes
RACE: 400
eMTB: 140-340
TOUR: 140
ECO: 60

4 Modi / modes
TURBO: 340
eMTB: 140-340
TOUR: 140
ECO: 60

FAZUA

FAZUA RIDE 60

FAZUA RIDE 60

- ▶ das kleinste, leichteste, fortgeschrittenste sportliche e-light-System
 - ▶ Motorgewicht 1,96 kg
 - ▶ Akkukapazität 430 Wh
 - ▶ Zusatzakku mit 210 Wh erhältlich
 - ▶ 60 Nm max. Drehmoment
-
- ▶ *smallest and most advanced sportive e-light-system*
 - ▶ *motor weight 1.96 kg*
 - ▶ *battery capacity 430 Wh*
 - ▶ *range extender with 210 Wh available*
 - ▶ *60 Nm max. torque*



FAZUA APP

Mit der FAZUA App lassen sich die Fahrmodi komplett individualisieren und vorgefertigte Profile können direkt heruntergeladen werden.

With the FAZUA app, the riding modes can be completely individualized, predefined profiles can be downloaded directly and updates can be carried out wirelessly.



FAZUA TOOLBOX SOFTWARE

Die FAZUA Desktop Software ermöglicht dem Händler, aber auch Radfahrern selbst, unkompliziert Konfigurationen, Updates und Fehlerdiagnose über den eigenen Computer.

The FAZUA desktop Toolbox Software provides dealers and the cyclists themselves with uncomplicated configurations, updates and error diagnostics on their own computer.



MRS Modular Rail System









Unser patentiertes Modular Rail System, kurz MRS genannt, ist als Schienensystem im Unterrohr integriert. Es ermöglicht, unsere MRS Produkte sowie jegliche Accessoires über den MRS Multimount an einer frei wählbaren Position im Bereich der Schiene zu montieren.

Our patented Modular Rail System, called MRS for short, is integrated in the down tube. With the MRS Multimount, our MRS products and any accessories can be mounted anywhere on the rail.

XLC MRS MODULAR RAIL SYSTEM



2502402006 2502402005 2502402007 2502402008	MR-S12 450 ml MR-S12 600 ml MR-S13 650 ml MR-S14 700 ml	XLC The Bottle Set	
2502408001	MR-S10	XLC MRS Multimount black, incl. mounting material	
2502408003	MR-S15	XLC MRS FidLock Rail after MY21	
2502400500	MR-S02	XLC MRS Rail Lock not keyed alike + 2 keys	
2502400600	MR-S03	XLC MRS Cable Lock 100cm, Ø12 mm	
2502400700	MR-S04	XLC MRS Chain Lock 85 cm, 2,9"	

XLC Bike Carrier Almada Work-E VC-C07

XLC Heckträger Almada Work-E VC-C07



2503311000 VC-C07

XLC Bike Carrier Almada Work-E - foldable, for 2 ebikes; collapsible even with bikes mounted

XLC Heckträger Almada Work-E - klappbar, für 2 E-Bikes

All XLC products online

Alle XLC Produkte online







XLC-PARTS.COM





click me

BIKEPARTS



ARTICLE #	DESCRIPTION	BIKEMODEL/PART	COLOR	PICTURE
CABLE GUIDES // COVERS				
FRCG0015	Cable guide top / left side	PATH RIOT RIOT CF	black flat	
FRCG0016	Cable guide bottom / left side	PATH RIOT RIOT CF	black flat	
FRCG0017	Cable guide top / right side	PATH RIOT RIOT CF	black flat	
FRCG0018	Cable guide bottom / right side	PATH RIOT RIOT CF	black flat	
FRCG0019	Cable inlet cover (for SRAM AXS)	PATH RIOT RIOT CF	black flat	
FROT0238	Cable guide right	PATH RIOT PATH ASKET ADVANCED	black flat	
FROT0256	Cable inlet right side - single	LECTOR PRO LECTOR UNIVERSAL LECTOR ADVANCED PATH ASKET	black flat	
FROT0260	Cable inlet right side - closed	LECTOR PRO LECTOR UNIVERSAL LECTOR ADVANCED	black flat	
FROT0237	Cable inlet left side - double	LECTOR PRO LECTOR UNIVERSAL LECTOR ADVANCED PATH RIOT PATH ASKET	black flat	
FROT0257	Cable inlet left side - single	LECTOR PRO LECTOR UNIVERSAL LECTOR ADVANCED PATH ASKET	black flat	
FRCG0022	Cover for front derailleur cable / tight cable	ASKET	black flat	

ARTICLE #	DESCRIPTION	BIKEMODEL/PART	COLOR	PICTURE
PATH RIOT // RIOT CF				
FRPR0088	Seatstay protector	PATH RIOT RIOT CF	black flat	
FROT0218	Brake mount 200 mm	PATH RIOT RIOT CF	black flat	
FROT0219	Brake mount 203 mm	PATH RIOT RIOT CF	black flat	
SMF0026	VPP Fender	PATH RIOT RIOT CF	black flat	
FRPR0087	chainstay protector	PATH RIOT RIOT CF	black flat	
FROT0242	Engine cover	PATH RIOT	black flat	
FROT0255	Fork bumper	PATH RIOT (ONLY SIZE S)	black flat	





ARTICLE #	DESCRIPTION	BIKEMODEL/PART	COLOR	PICTURE
PATH ASKET				
FRPR0086	Chainstay protector	PATH ASKET CF	black flat	
FROT0224	Cover drive unit	PATH ASKET CF	black flat	



BIKEPARTS







ARTICLE #	DESCRIPTION	BIKEMODEL/PART	COLOR	PICTURE
RIOT CF				

FR0T0262	Fork bumper	RIOT CF (ONLY SIZE S)	black flat	
FRPR0104	Downtube protector	RIOT CF	black flat	

ARTICLE #	DESCRIPTION	BIKEMODEL/PART	COLOR	PICTURE
E-RIOT // RIOT				







	Chainstay / seatstay protector			
FRPR0066 FRPR0055	S M-XL	E-RIOT RIOT	black flat	
FRPR0054	Chainstay / yoke protector	E-RIOT RIOT	black flat	
FRPR0053	Chainstay protection	E-RIOT RIOT	black flat	
	Downtube cable cover			
FRPR0059 FRPR0060 FRPR0061	S M L-XL	E-RIOT	black flat	
	Motor cover BOSCH GEN4 engine			
FRPR0063 FRPR0064	left side right side	E-RIOT	black flat	

ARTICLE #	DESCRIPTION	BIKEMODEL/PART	COLOR	PICTURE
ASKET CF				
FDOT002	Front derailleur mount cover	ASKET CF	black flat	
BBPR001	Skidplate	ASKET CF	black flat	
FDOT001	Front derailleur mount	ASKET CF	black flat	
FROT0263	Chainstay protector	ASKET CF	black flat	



ARTICLE #	DESCRIPTION	BIKEMODEL/PART	COLOR	PICTURE
NIRVANA				
FRPR0027 FRPR0028	Chainstay protection XS/S M/L/XL	NIRVANA	black flat	
AM0027	Fender kit	NIRVANA	black flat	
KT0128	Carrier adapter set (with screws)	NIRVANA	black flat	
FRPR0029 FRPR0030 FRPR0031 FRPR0032	Downtube cover XXS XS S M-XL	NIRVANA	black flat	
FROT0068	Chainstay cable clip	NIRVANA	black flat	
FROT0070	O-Ring for chainstay clip	NIRVANA	black flat	

BIKEPARTS

ARTICLE #	DESCRIPTION	BIKEMODEL/PART	COLOR	PICTURE
LECTOR				

BRSM0194	Brakemount PM160	LECTOR MY24	black flat	
BRSM0189	Brakemount PM180	LECTOR MY24	black flat	
BRSC0002	Flipchip 160/180 mm	LECTOR MY24	black flat	
AM0093	Chain guide	LECTOR MY24	black flat	
AM0094	Counter sunk screw IS3 - M5 x 20 mm 5 Nm (for chain guide AM0093)	LECTOR MY24	black flat	
FRPR0093	Chainstay protector	LECTOR MY24	black flat	

ARTICLE #	DESCRIPTION	BIKEMODEL/PART	COLOR	PICTURE
DIVERSE				

FR0T0075 FR0T0062 FRPR0065	Cable guide LECTOR NIRVANA E-RIOT	LECTOR NIRVANA E-RIOT	black flat	
AM0061 AM0062	Axle tool with bottle opener for X12 (axle AM0059) for ASX (axle AM0063)	for X12 for ASX	black flat	

COULDN'T FIND WHAT YOU'RE LOOKING FOR? NOCH NICHT FÜNDIG GEWORDEN?

Find all extensive spare parts on our website.

Das umfangreiche Ersatzteilsortiment findet ihr auf der Website.

[SHOP.ACENTRY.COM/LOGIN](https://shop.accentry.com/login)



click me

Find detailed exploded diagrams and views of spare parts on our website.

Detaillierte Explosionszeichnungen und Ersatzteilansichten auf unserer Website.

[GHOST-BIKES.COM/DOWNLOADS/EXPLOSIONSZEICHNUNGEN](https://ghost-bikes.com/downloads/explosionszeichnungen)



click me

For complaints please use the new Accell service portal in Accentry.

Für Reklamationen bitte das neue Accell Serviceportal im Accentry nutzen.









[SERVICE.ACENTRY.COM](https://service.accentry.com)



click me











SCHALTAUGENÜBERSICHT // HANGER OVERVIEW

PICTURE		NAME	ART.-NR.	BIKE
INSIDE	OUTSIDE			
		SRAM UDH Hanger set with nut AL black	FRHG0061	E-ASX '21, '22, '23, '24 RIOT AL '21, '22, '23, '24 RIOT YOUTH '22, '24 RIOT CF '23, '24 E-RIOT '21, '22, '23, '24 LECTOR FS '21, '22, '23, '24 E-TERU '23, '24 (not for E-TERU Essential) KATO FS '22, '23, '24 PATH RIOT CF '23 PATH ASKET '23 ASKET CF '24 LECTOR '24
		Hanger AL black Set incl. screws	FRHG0064	KATO KID 20" '22, '23, '24 KATO KID 24" '22, '23, '24 LANAO KID 20" '22, '23, '24 LANAO KID 24" '22, '23, '24
		Hanger RD 156	FRHG0003	ROAD RAGE '18, '19 FIRE ROAD RAGE '18, '19, '20, '21 ENDLESS ROAD RAGE '18, '19, '20 VIOLENT ROAD RAGE '18, '19 ROAD RAGE PRO '22
		Hanger GRH-21bl black Screw 2x M4 x 8 mm T20 black	FRHG0004 FRSC0059	KATO '21, '22, '23, '24 LANAO '21, '22, '23, '24 SQUARE TREKKING '21, '22, '23, '24 SQUARE CROSS '21, '22, '23, '24
		Hanger set with nut & screw AL6061 black thread P1	FRHG0065	ASKET AL '23, '24
		Hanger AL6061-T6 black anodized	FRHG0025	NIRVANA '20, '21, '22, '23, '24 LECTOR LC SF '20, '21, '22, '23 E-TERU YOUTH '23 E-TERU ESSENTIAL '23, '24 E-TERU '21, '22, '24
		Hanger set with nut & screw AL6061 black thread P1.5	FRHG0062	ROAD RAGE AL '21, '22
		Adjustable hanger right side	W0017215	E-TERU LOW UNIVERSAL '22 E-TERU LOW ESSENTIAL '22
		Adjustable brakemount left side	W0017214	E-TERU LOW UNIVERSAL '22 E-TERU LOW ESSENTIAL '22

STÄNDERÜBERSICHT // KICKSTAND OVERVIEW

MODEL	ADAPTER #	ART #	KICKSTAND	INCH	KSA (MM)	POSITION
E-TERU / E-TERU LOW	GA0128	2502618057	XLC Seitenständer KS-C09 (M6 holes)	24-29	18	rear
KATO FS & RIOT YOUTH						
NIRVANA TOUR & NIRVANA TRAIL						
E-RIOT AL / E-RIOT CF	KT0127	AM0013	Ursus MOOI R90 (M6 threads)	26-29	40	center
RIOT AL						
KATO 27,5", 29"	no adapter needed					
LANAO 27,5", 29"						
SQUARE CROSS		2502618033	XLC Seitenständer KS-C08 (M6 holes)	16-24	18	rear
SQUARE TREKKING						
KATO 20" / LANAQ 20"		2502618055	XLC Seitenständer KS-C09 (M6 holes)	24-29	40	rear
KATO 24" / LANAQ 24"						
ASKET AL		2502618057	XLC Seitenständer KS-C09 (M6 holes)	24-29	18	rear
E-ASX (only 130 mm Version)						

KICKSTAND	THREADS // HOLES	INCH	KSA (MM)	COLOR	ART.NR.	PICTURE
Ursus MOOI R90 rear	M6 threads	24-29	40	black	AM0013	
XLC Seitenständer KS-B04	M10 thread	24-28	40	black	2502618030	
XLC Seitenständer KS-C08	M6 holes	16-24	18	black	2502618033	
XLC Seitenständer KS-C09	M6 holes	24-29	40	black	2502618055	
XLC Seitenständer KS-C09	M6 holes	24-29	18	black	2502618057	
Kickstand adapter (E-TERU, E-TERU LOW, KATO FS, RIOT YOUTH)	M6 threads	-	18	black	GA0128	
Kickstand adapter (E-RIOT AL / CF, RIOT AL)	M6 threads	-	18	black	KT0127	
Kickstand adapter (NIRVANA TOUR, NIRVANA TRAIL)	M6 threads	-	18	black	KT0126	

Find all technical documents on our website
Alle technischen Dokumente findest du auf unserer Website

[GHOST-BIKES.COM/DOWNLOADS/TECHISCHE-DOKUMENTE-1](https://ghost-bikes.com/downloads/technische-dokumente-1)



click me



INFO

BIKE ANATOMIE

GEOMETRIEN

TECHNIK LEXIKON

EINSATZBEREICHE

LEGENDE SPEC ICONS/ KEY SPEC ICONS









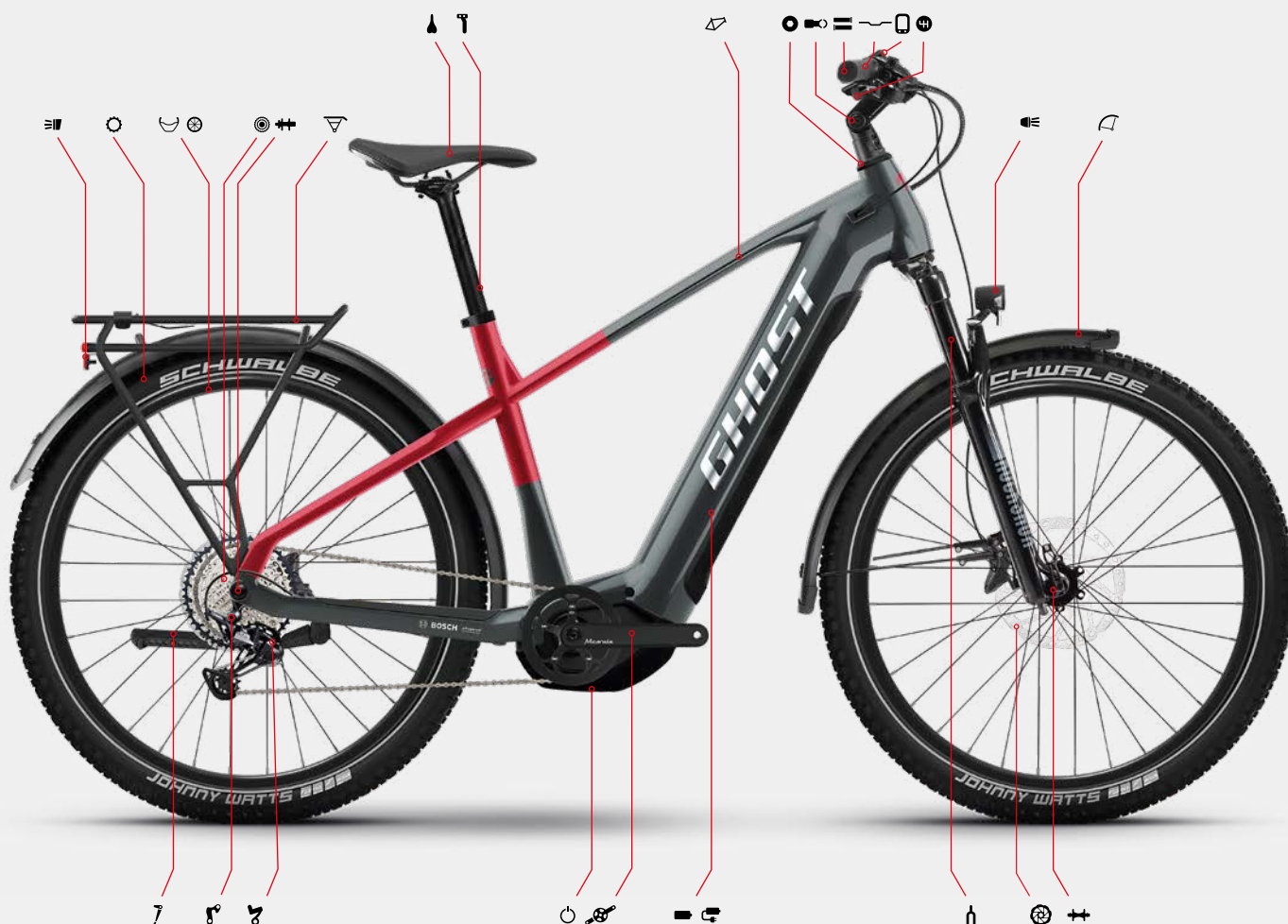









// ERKLÄRUNG / EXPLANATION

 RAHMEN FRAME	 SCHALTWERK REAR DERAILLEUR	 LAUFRÄDER WHEELSET	 SATTEL SADDLE
 GABEL UND FEDERWEG VORNE FORK AND FRONT TRAVEL	 UMWERFER FRONT DERAILLEUR	 REIFEN TIRES	 STEUERSATZ HEADSET
 FEDERELEMENT UND FEDERWEG HINTEN SHOCK AND REAR TRAVEL	 SCHALTHEBEL SHIFTER	 FELGE RIM	 INNENLAGER BOTTOM BRACKET
 VORBAU STEM	 KURBELSATZ CRANKSET	 NABE VORNE FRONT HUB	 SCHALTAUGE HANGER
 GRIFFE GRIPS	 KASSETTE CASSETTE	 NABE HINTEN REAR HUB	
 LENKER HANDLEBAR	 BREMSEN BRAKES	 SATTELSTÜTZE SEATPOST	

LEGENDE SPEC ICONS/ KEY SPEC ICONS



// ERKLÄRUNG / EXPLANATION

 RAHMEN FRAME	 SCHALTHEBEL SHIFTER	 NABE HINTEN REAR HUB	 DISPLAY DISPLAY
 GABEL UND FEDERWEG VORNE FORK AND FRONT TRAVEL	 KURBELSATZ CRANKSET	 SATTELSTÜTZE SEATPOST	 MOTOR MOTOR
 FEDERELEMENT UND FEDERWEG HINTEN SHOCK AND REAR TRAVEL	 KASSETTE CASSETTE	 SATTEL SADDLE	 BATTERIE BATTERY
 VORBAU STEM	 BREMSEN BRAKES	 GEPÄCKTRÄGER CARRIER	 LADEGERÄT CHARGER
 GRIFFE GRIPS	 LAUFRÄDER WHEELSET	 SCHUTZBLECHE FENDERS	 STEUERSATZ HEADSET
 LENKER HANDLEBAR	 REIFEN TIRES	 STÄNDER KICK STAND	 INNENLAGER BOTTOM BRACKET
 SCHALTWERK REAR DERAILLEUR	 FELGE RIM	 SCHEINWERFER LIGHTS FRONT	 SCHALTAUGE HANGER
 UMWERFER FRONT DERAILLEUR	 NABE VORNE FRONT HUB	 RÜCKLICHT LIGHTS REAR	



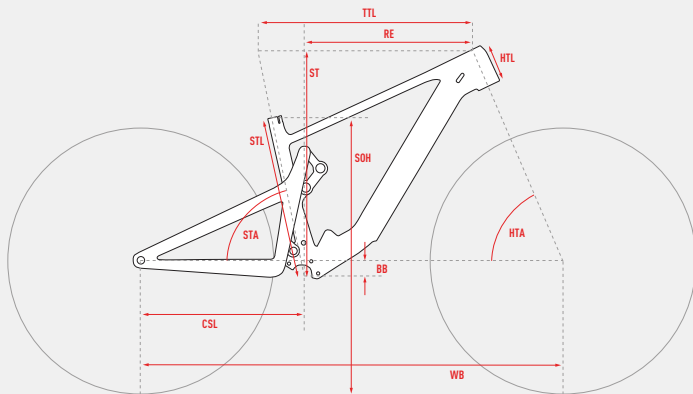









PATH RIOT











ALL DIMENSIONS IN MM (EXCEPT HTA AND STA IN °)









ALLE MAßE IN MM (AUSNAHME HTA UND STA IN °)

- STL** SEAT TUBE LENGTH
SITZROHRLÄNGE
- CSL** CHAINSTAY LENGTH
KETTENSTREBENLÄNGE
- TTL** TOP TUBE LENGTH
OBERROHRLÄNGE
- HTL** HEAD TUBE LENGTH
STEUERROHRLÄNGE
- HTA** HEAD TUBE ANGLE
STEUERROHRWINKEL
- STA** SEAT TUBE ANGLE
SITZROHRWINKEL
- BB** BOTTOM BRACKET DROP
INNENLAGERABSENKUNG
- WB** WHEELBASE
RADSTAND
- ST** STACK
STACK
- RE** REACH
REACH
- SOH** STANDOVER HEIGHT
ÜBERSTANDSHÖHE
-  HEAD SET DIAMETER (UPPER / LOWER)
STEUERSATZDURCHMESSER (OBEN / UNTEN)

-  AXLE STANDARD (REAR / FRONT)
ACHSENSTANDARD (HINTEN / VORNE)
-  BOTTOM BRACKET STANDARD
TRETLAGERSTANDARD
-  SEAT POST DIAMETER
SÄTTELSTÜTZENDURCHMESSER
-  SHOCK HARDWARE (Ø 8 MM)
DÄMPFERBÜCHSENMAßE (Ø 8 MM)
-  SHOCK LENGTH
DÄMPFERENBAULÄNGE
-  SHOCK TRAVEL
DÄMPFERHUB
-  FRONT FORK TRAVEL
FEDERWEG VORNE
-  REAR WHEEL TRAVEL
FEDERWEG HINTEN
-  STEM LENGTH
VORBAULÄNGE
-  HANDLEBAR WIDTH
LENKERBREITE
-  CRANK LENGTH
KURBELLÄNGE
-  SEAT TUBE BOTTLE MOUNT
FLASCHE SÄTTELROHR
-  DOWNTUBE BOTTLE MOUNT
FLASCHE UNTERROHR

	STL	CSL	TTL	HTL	HTA	STA	BB	WB	ST	RE	SOH																
PATH RIOT "30"																											
S	417	446	581	90	63.5	76.5	34.2	1224	607	435	778	44 / 56	148/110	Fazua Ride 60	34,9	Trunnion / 30x10	185	55	160	140	50	800	165	-	500		
M	441	446	615	110	63.5	76.5	34.2	1263	626	465	792	44 / 56	148/110	Fazua Ride 60	34,9	Trunnion / 30x10	185	55	160	140	50	800	165	-	750		
L	465	455	647	140	63.5	76.5	29.5	1312	648	492	817	44 / 56	148/110	Fazua Ride 60	34,9	Trunnion / 30x10	185	55	160	140	50	800	165	-	750		
XL	489	455	681	160	63.5	76.5	29.5	1350	666	522	835	44 / 56	148/110	Fazua Ride 60	34,9	Trunnion / 30x10	185	55	160	140	50	800	165	-	750		

	STL	CSL	TTL	HTL	HTA	STA	BB	WB	ST	RE	SOH																
PATH RIOT FULL PARTY																											
S	417	446	581	90	63.5	76.5	34.2	1224	607	435	778	44/56	148/110	Fazua Ride 60	34,9	Trunnion / 30x10	185	55	160	140	40	800	170	-	0,5		
M	441	446	615	110	63.5	76.5	34.3	1263	626	465	792	44/56	148/110	Fazua Ride 60	34,9	Trunnion / 30x10	185	55	160	140	40	800	170	-	0,75		
L	465	455	647	140	63.5	76.5	29.5	1312	648	492	817	44/56	148/110	Fazua Ride 60	34,9	Trunnion / 30x10	185	55	160	140	40	800	175	-	0,75		
XL	489	455	681	160	63.5	76.5	29.6	1350	666	522	835	44/56	148/110	Fazua Ride 60	34,9	Trunnion / 30x10	185	55	160	140	40	800	175	-	0,75		

	STL	CSL	TTL	HTL	HTA	STA	BB	WB	ST	RE	SOH																
PATH RIOT ADVANCED																											
S	417	446	581	90	63.5	76.5	34.2	1224	607	435	778	44/56	148/110	Fazua Ride 60	34,9	Trunnion / 30x10	185	55	160	140	40	800	170	-	0,5		
M	441	446	615	110	63.5	76.5	34.3	1263	626	465	792	44/56	148/110	Fazua Ride 60	34,9	Trunnion / 30x10	185	55	160	140	40	800	170	-	0,75		
L	465	455	647	140	63.5	76.5	29.5	1312	648	492	817	44/56	148/110	Fazua Ride 60	34,9	Trunnion / 30x10	185	55	160	140	40	800	175	-	0,75		
XL	489	455	681	160	63.5	76.5	29.6	1350	666	522	835	44/56	148/110	Fazua Ride 60	34,9	Trunnion / 30x10	185	55	160	140	40	800	175	-	0,75		



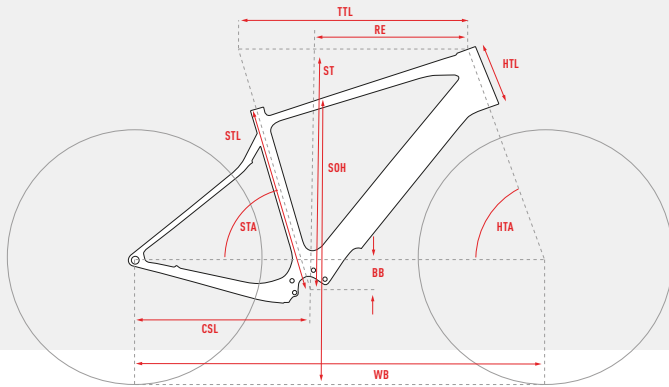









PATHASKET



ALL DIMENSIONS IN MM (EXCEPT HTA AND STA IN °)

ALLE MAßE IN MM (AUSNAHME HTA UND STA IN °)

- STL** SEAT TUBE LENGTH
SITZROHRLÄNGE
- CSL** CHAINSTAY LENGTH
KETTENSTREBENLÄNGE
- TTL** TOP TUBE LENGTH
OBERROHRLÄNGE
- HTL** HEAD TUBE LENGTH
STEUERROHRLÄNGE
- HTA** HEAD TUBE ANGLE
STEUERROHRWINKEL
- STA** SEAT TUBE ANGLE
SITZROHRWINKEL
- BB** BOTTOM BRACKET DROP
INNENLAGERABSENKUNG
- WB** WHEELBASE
RADSTAND
- ST** STACK
STACK
- RE** REACH
REACH
- SOH** STANDOVER HEIGHT
ÜBERSTANDSHÖHE
-  HEAD SET DIAMETER (UPPER / LOWER)
STEUERSATZDURCHMESSER (OBEN / UNTEN)

-  AXLE STANDARD (REAR / FRONT)
ACHSENSTANDARD (HINTEN / VORNE)
-  BOTTOM BRACKET STANDARD
TRETLAGERSTANDARD
-  SEAT POST DIAMETER
SITTELSTÜTZENDURCHMESSER
-  SHOCK HARDWARE (Ø 8 MM)
DÄMPFERBUCHSENMAßE (Ø 8 MM)
-  SHOCK LENGTH
DÄMPFEREINBAULÄNGE
-  SHOCK TRAVEL
DÄMPFERHUB
-  FRONT FORK TRAVEL
FEDERWEG VORNE
-  REAR WHEEL TRAVEL
FEDERWEG HINTEN
-  STEM LENGTH
VORBAULLÄNGE
-  HANDLEBAR WIDTH
LENKERBREITE
-  CRANK LENGTH
KURBELLENLÄNGE
-  SEAT TUBE BOTTLE MOUNT
FLASCHE SITTELROHR
-  DOWNTUBE BOTTLE MOUNT
FLASCHE UNTERROHR

STL CSL TTL HTL HTA STA BB WB ST RE SOH              

PATH ASKET PRO

S	440	445	564	130	69.8	73.7	70	1083	586	394	720	ZS44/ZS56	148/100	31,6	- / -	0	0	0	0	60	420	170	0,5	0,5
M	480	450	588	160	70	73.7	70	1110	615	408	760	ZS44/ZS56	148/100	31,6	- / -	0	0	0	0	60	440	170	0,75	0,75
L	500	455	616	190	70.3	73.6	65	1144	639	429	780	ZS44/ZS56	148/100	31,6	- / -	0	0	0	0	60	460	175	0,75	0,75
XL	540	460	640	220	70.5	73.6	65	1171	669	443	820	ZS44/ZS56	148/100	31,6	- / -	0	0	0	0	60	480	175	0,75	0,75

STL CSL TTL HTL HTA STA BB WB ST RE SOH              





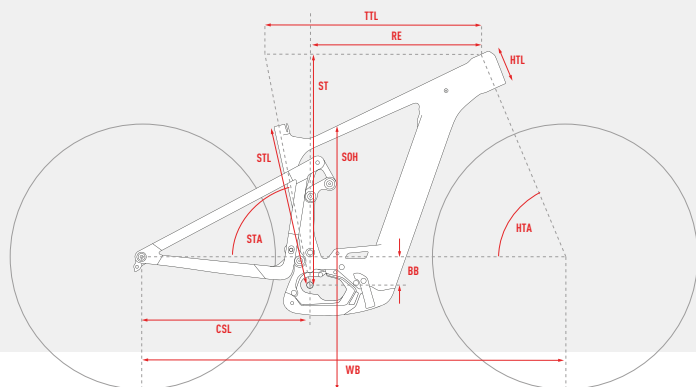









PATH ASKET ADVANCED

S	440	445	564	130	69.8	73.7	70	1083	586	394	720	0 / 0	148/100	31,6	- / -	0	0	40	0	60	420	170	0,5	0,5
M	480	450	588	160	70	73.7	70	1110	615	408	760	0 / 0	148/100	31,6	- / -	0	0	40	0	60	440	170	0,75	0,75
L	500	455	616	190	70.3	73.6	65	1144	639	429	780	0 / 0	148/100	31,6	- / -	0	0	40	0	60	460	175	0,75	0,75
XL	540	460	640	220	70.5	73.6	65	1171	669	443	820	0 / 0	148/100	31,6	- / -	0	0	40	0	60	480	175	0,75	0,75



ALL DIMENSIONS IN MM (EXCEPT HTA AND STA IN °)



ALLE MAßE IN MM (AUSNAHME HTA UND STA IN °)

- STL** SEAT TUBE LENGTH
SITZROHRLÄNGE
- CSL** CHAINSTAY LENGTH
KETTENSTREBENLÄNGE
- TTL** TOP TUBE LENGTH
OBERROHRLÄNGE
- HTL** HEAD TUBE LENGTH
STEUERROHRLÄNGE
- HTA** HEAD TUBE ANGLE
STEUERROHRWINKEL
- STA** SEAT TUBE ANGLE
SITZROHRWINKEL
- BB** BOTTOM BRACKET DROP
INNENLAGERABSENKUNG
- WB** WHEELBASE
RADSTAND
- ST** STACK
STACK
- RE** REACH
REACH
- SOH** STANDOVER HEIGHT
ÜBERSTANDSHÖHE
-  HEAD SET DIAMETER (UPPER / LOWER)
STEUERSATZDURCHMESSER (OBEN / UNTEN)
-  AXLE STANDARD (REAR / FRONT)
ACHSENSTANDARD (HINTEN / VORNE)
-  BOTTOM BRACKET STANDARD
TRETLAGERSTANDARD
-  SEAT POST DIAMETER
SÄTTELSTÜTZENDURCHMESSER
-  SHOCK HARDWARE (Ø 8 MM)
DÄMPFERBUCHSENMAßE (Ø 8 MM)
-  SHOCK LENGTH
DÄMPFERENBAULÄNGE
-  SHOCK TRAVEL
DÄMPFERHUB
-  FRONT FORK TRAVEL
FEDERWEG VORNE
-  REAR WHEEL TRAVEL
FEDERWEG HINTEN
-  STEM LENGTH
VORBAULÄNGE
-  HANDLEBAR WIDTH
LENKERBREITE
-  CRANK LENGTH
KURBELLÄNGE
-  SEAT TUBE BOTTLE MOUNT
FLASCHE SÄTTELROHR
-  DOWNTUBE BOTTLE MOUNT
FLASCHE UNTERROHR

STL CSL TTL HTL HTA STA BB WB ST RE SOH              

E-RIOT AM "30"

	STL	CSL	TTL	HTL	HTA	STA	BB	WB	ST	RE	SOH														
S	417	435	570	120	65.5	76	24.2	1197	617	442	746	44 / 56	148/110	BOSCH BES3	34,9	Trunnion / 30x10	205	65	160	160	50	800	165	-	Fidlock 0,45
M	441	455	587	100	65.5	77	37.6	1248	627	468	740	44 / 56	148/110	BOSCH BES3	34,9	Trunnion / 30x10	205	65	160	160	50	800	165	-	Fidlock 0,45
L	465	455	617	140	65.5	77	37.6	1285	663	489	748	44 / 56	148/110	BOSCH BES3	34,9	Trunnion / 30x10	205	65	160	160	50	800	170	-	Fidlock 0,6
XL	489	455	650	160	65.5	77	37.6	1323	682	519	751	44 / 56	148/110	BOSCH BES3	34,9	Trunnion / 30x10	205	65	160	160	50	800	170	-	Fidlock 0,6

STL CSL TTL HTL HTA STA BB WB ST RE SOH              

E-RIOT AM PRO

	STL	CSL	TTL	HTL	HTA	STA	BB	WB	ST	RE	SOH														
S	417	435	570	120	65.5	76	24.2	1197	617	442	746	44 / 56	148/110	BOSCH BES 3	34,9	Trunnion / 30x10	205	65	160	160	45	760	165	-	Fidlock 0,45
M	441	455	587	100	65.5	77	37.6	1248	627	468	740	44 / 56	148/110	BOSCH BES 3	34,9	Trunnion / 30x10	205	65	160	160	45	780	165	-	Fidlock 0,45
L	465	455	617	140	65.5	77	37.6	1285	663	489	748	44 / 56	148/110	BOSCH BES 3	34,9	Trunnion / 30x10	205	65	160	160	45	780	170	-	Fidlock 0,6
XL	489	455	650	160	65.5	77	37.6	1323	682	519	751	44 / 56	148/110	BOSCH BES 3	34,9	Trunnion / 30x10	205	65	160	160	45	780	170	-	Fidlock 0,6

STL CSL TTL HTL HTA STA BB WB ST RE SOH              

E-RIOT AM ADVANCED

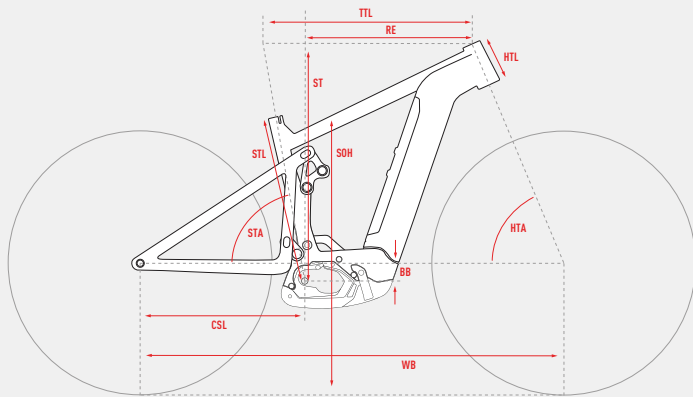

	STL	CSL	TTL	HTL	HTA	STA	BB	WB	ST	RE	SOH														
S	417	435	570	120	65.5	76	24.2	1197	617	442	746	44 / 56	148/110	BOSCH BES3	34,9	Trunnion / 30x10	205	65	160	160	50	800	165	-	Fidlock 0,45
M	441	455	587	100	65.5	77	37.6	1248	627	468	740	44 / 56	148/110	BOSCH BES3	34,9	Trunnion / 30x10	205	65	160	160	50	800	165	-	Fidlock 0,45
L	465	455	617	140	65.5	77	37.6	1285	663	489	748	44 / 56	148/110	BOSCH BES3	34,9	Trunnion / 30x10	205	65	160	160	50	800	170	-	Fidlock 0,6
XL	489	455	650	160	65.5	77	37.6	1323	682	519	751	44 / 56	148/110	BOSCH BES3	34,9	Trunnion / 30x10	205	65	160	160	50	800	170	-	Fidlock 0,6















ALL DIMENSIONS IN MM (EXCEPT HTA AND STA IN °)

ALLE MAßE IN MM (AUSNAHME HTA UND STA IN °)













- STL** SEAT TUBE LENGTH
SITZROHRLÄNGE
- CSL** CHAINSTAY LENGTH
KETTENSTREBELÄNGE
- TTL** TOP TUBE LENGTH
OBERROHRLÄNGE
- HTL** HEAD TUBE LENGTH
STEUERROHRLÄNGE
- HTA** HEAD TUBE ANGLE
STEUERROHRWINKEL
- STA** SEAT TUBE ANGLE
SITZROHRWINKEL
- BB** BOTTOM BRACKET DROP
INNENLAGERABSENKUNG
- WB** WHEELBASE
RADSTAND
- ST** STACK
STACK
- RE** REACH
REACH
- SOH** STANDOVER HEIGHT
ÜBERSTANDSHÖHE
-  HEAD SET DIAMETER (UPPER / LOWER)
STEUERSATZDURCHMESSER (OBEN / UNTEN)

-  AXLE STANDARD (REAR / FRONT)
ACHSENSTANDARD (HINTEN / VORNE)
-  BOTTOM BRACKET STANDARD
TRETLAGERSTANDARD
-  SEAT POST DIAMETER
SÄTTELSTÜTZENDURCHMESSER
-  SHOCK HARDWARE (Ø 8 MM)
DÄMPFERBUCHSENMAßE (Ø 8 MM)
-  SHOCK LENGTH
DÄMPFERENBAULÄNGE
-  SHOCK TRAVEL
DÄMPFERHUB
-  FRONT FORK TRAVEL
FEDERWEG VORNE
-  REAR WHEEL TRAVEL
FEDERWEG HINTEN
-  STEM LENGTH
VORBAULÄNGE
-  HANDLEBAR WIDTH
LENKERBREITE
-  CRANK LENGTH
KURBELLÄNGE
-  SEAT TUBE BOTTLE MOUNT
FLASCHE SÄTTELROHR
-  DOWNTUBE BOTTLE MOUNT
FLASCHE UNTERROHR

STL CSL TTL HTL HTA STA BB WB ST RE SOH            













E-RIOT AM UNIVERSAL

	STL	CSL	TTL	HTL	HTA	STA	BB	WB	ST	RE	SOH														
S	417	435	588	120	65.5	76	24	1197	617	442	746	44 / 56	148/110	BOSCH BES 3	34,9	Trunnion / 30x10	205	65	160	160	45	760	165	-	Fidlock 0,45
M	441	455	618	100	65.5	77	38	1248	627	468	740	44 / 56	148/110	BOSCH BES 3	34,9	Trunnion / 30x10	205	65	160	160	45	780	165	-	Fidlock 0,45
L	465	455	648	140	65.5	77	38	1285	663	489	748	44 / 56	148/110	BOSCH BES 3	34,9	Trunnion / 30x10	205	65	160	160	45	780	170	-	Fidlock 0,6
XL	489	455	682	160	65.5	77	38	1323	682	519	751	44 / 56	148/110	BOSCH BES 3	34,9	Trunnion / 30x10	205	65	160	160	45	780	170	-	Fidlock 0,6

STL CSL TTL HTL HTA STA BB WB ST RE SOH            

E-RIOT AM ESSENTIAL

	STL	CSL	TTL	HTL	HTA	STA	BB	WB	ST	RE	SOH														
S	417	435	588	120	65.5	76	24	1197	617	442	746	44 / 56	148/110	BOSCH BES 3	34,9	Trunnion / 30x10	205	65	160	160	45	760	165	-	Fidlock 0,45
M	441	455	618	100	65.5	77	38	1248	627	468	740	44 / 56	148/110	BOSCH BES 3	34,9	Trunnion / 30x10	205	65	160	160	45	780	165	-	Fidlock 0,45
L	465	455	648	140	65.5	77	38	1285	663	489	748	44 / 56	148/110	BOSCH BES 3	34,9	Trunnion / 30x10	205	65	160	160	45	780	170	-	Fidlock 0,6
XL	489	455	682	160	65.5	77	38	1323	682	519	751	44 / 56	148/110	BOSCH BES 3	34,9	Trunnion / 30x10	205	65	160	160	45	780	170	-	Fidlock 0,6

STL CSL TTL HTL HTA STA BB WB ST RE SOH            

E-RIOT TRAIL

	STL	CSL	TTL	HTL	HTA	STA	BB	WB	ST	RE	SOH														
S	417	430	566	120	66	76	25.4	1180	605	441	772	44 / 56	148/110	BOSCH BES3	34,9	Trunnion / 30x10	185	55	150	140	50	800	165	-	Fidlock 0,45
M	441	450	580	120	66	77	38.6	1230	634	459	800	44 / 56	148/110	BOSCH BES3	34,9	Trunnion / 30x10	185	55	150	140	50	800	165	-	Fidlock 0,45
L	465	450	612	140	66	77	38.6	1266	652	487	803	44 / 56	148/110	BOSCH BES3	34,9	Trunnion / 30x10	185	55	150	140	50	800	170	-	Fidlock 0,6
XL	489	450	645	160	66	77	38.6	1303	670	516	802	44 / 56	148/110	BOSCH BES3	34,9	Trunnion / 30x10	185	55	150	140	50	800	170	-	Fidlock 0,6

E/ASX

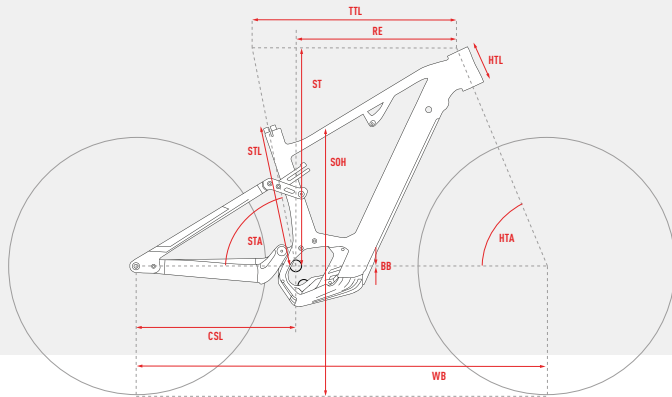

ALL DIMENSIONS IN MM (EXCEPT HTA AND STA IN °)

ALLE MADE IN MM (AUSNAHME HTA UND STA IN °)

- STL** SEAT TUBE LENGTH
SITZROHRLÄNGE
- CSL** CHAINSTAY LENGTH
KETTENSTREBELÄNGE
- TTL** TOP TUBE LENGTH
OBERROHRLÄNGE
- HTL** HEAD TUBE LENGTH
STEUERROHRLÄNGE
- HTA** HEAD TUBE ANGLE
STEUERROHRWINKEL
- STA** SEAT TUBE ANGLE
SITZROHRWINKEL
- BB** BOTTOM BRACKET DROP
INNENLAGERABSENKUNG
- WB** WHEELBASE
RADSTAND
- ST** STACK
STACK
- RE** REACH
REACH
- SOH** STANDOVER HEIGHT
ÜBERSTANDSHÖHE
- HTA** HEAD SET DIAMETER (UPPER / LOWER)
STEUERSATZDURCHMESSER (OBEN / UNTEN)
- AS** AXLE STANDARD (REAR / FRONT)
ACHSENSTANDARD (HINTEN / VORNE)
- BS** BOTTOM BRACKET STANDARD
TRETLAGERSTANDARD
- SP** SEAT POST DIAMETER
SÄTTELSTÜTZENDURCHMESSER
- SH** SHOCK HARDWARE (Ø 8 MM)
DÄMPFERBUCHSENMAßE (Ø 8 MM)
- SL** SHOCK LENGTH
DÄMPFERENBAULÄNGE
- ST** SHOCK TRAVEL
DÄMPFERHUB
- FF** FRONT FORK TRAVEL
FEDERWEG VORNE
- FR** REAR WHEEL TRAVEL
FEDERWEG HINTEN
- VL** STEM LENGTH
VORBAULLÄNGE
- HW** HANDLEBAR WIDTH
LENKERBREITE
- CL** CRANK LENGTH
KURBELLENGE
- SM** SEAT TUBE BOTTLE MOUNT
FLASCHE SÄTTELROHR
- DM** DOWNTUBE BOTTLE MOUNT
FLASCHE UNTERROHR



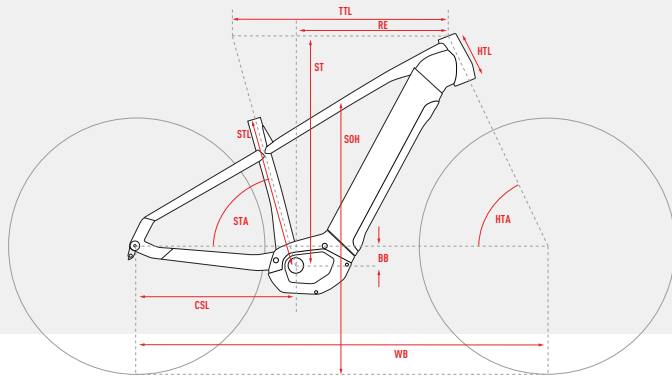









	STL	CSL	TTL	HTL	HTA	STA	BB	WB	ST	RE	SOH	AS	BS	SP	SH	ST	FF	FR	VL	HW	CL	SM	DM		
E-ASX 160 UNIVERSAL																									
S	390	460	587	100	64.5	76.5	-30	1230	631	435	735	44 / 56	148/110	BOSCH BES 3	31,6	25x8 / 15x8	230	60	160	160	45	760	165	-	0,5
M	430	460	609	110	65	76.5	-30	1248	641	455	749	44 / 56	148/110	BOSCH BES 3	31,6	25x8 / 15x8	230	60	160	160	45	780	165	-	0,5
L	470	460	633	130	65	76.5	-30	1276	659	475	748	44 / 56	148/110	BOSCH BES 3	31,6	25x8 / 15x8	230	60	160	160	45	780	170	-	0,5
XL	510	460	663	150	65	76.5	-30	1310	678	500	757	44 / 56	148/110	BOSCH BES 3	31,6	25x8 / 15x8	230	60	160	160	45	780	170	-	0,75
E-ASX 160 ESSENTIAL																									
S	390	460	587	100	64.5	76.5	-30	1230	631	435	735	44 / 56	148/110	BOSCH BES 3	31,6	25x8 / 15x8	230	60	160	160	45	760	165	-	0,5
M	430	460	609	110	65	76.5	-30	1248	641	455	749	44 / 56	148/110	BOSCH BES 3	31,6	25x8 / 15x8	230	60	160	160	45	800	165	-	0,5
L	470	460	633	130	65	76.5	-30	1276	659	475	748	44 / 56	148/110	BOSCH BES 3	31,6	25x8 / 15x8	230	60	160	160	45	800	170	-	0,5
XL	510	460	663	150	65	76.5	-30	1310	678	500	757	44 / 56	148/110	BOSCH BES 3	31,6	25x8 / 15x8	230	60	160	160	45	800	170	-	0,75
E-ASX 130 UNIVERSAL																									
S	390	460	588	110	65.5	76	-30	1216	611	436	738	44 / 56	148/110	BOSCH BES 3	31,6	25x8 / 15x8	230	50	130	130	45	760	165	-	0,5
M	430	460	610	120	66	76	-30	1233	621	455	756	44 / 56	148/110	BOSCH BES 3	31,6	25x8 / 15x8	230	50	130	130	45	780	165	-	0,5
L	470	460	634	140	66	76	-30	1261	640	475	753	44 / 56	148/110	BOSCH BES 3	31,6	25x8 / 15x8	230	50	130	130	45	780	170	-	0,75
XL	510	460	664	160	66	76	-30	1294	658	500	759	44 / 56	148/110	BOSCH BES 3	31,6	25x8 / 15x8	230	50	130	130	45	780	170	-	0,75
E-ASX 130 ESSENTIAL																									
S	390	460	588	110	65.5	76	-30	1216	611	436	738	44 / 56	148/110	BOSCH BES 3	31,6	25x8 / 15x8	230	50	130	130	45	760	165	-	0,5
M	430	460	610	120	66	76	-30	1233	621	455	756	44 / 56	148/110	BOSCH BES 3	31,6	25x8 / 15x8	230	50	130	130	45	780	165	-	0,5
L	470	460	634	140	66	76	-30	1261	640	475	753	44 / 56	148/110	BOSCH BES 3	31,6	25x8 / 15x8	230	50	130	130	45	780	170	-	0,75
XL	510	460	664	160	66	76	-30	1294	658	500	759	44 / 56	148/110	BOSCH BES 3	31,6	25x8 / 15x8	230	50	130	130	45	780	170	-	0,75

















ALL DIMENSIONS IN MM (EXCEPT HTA AND STA IN °)

ALLE MAßE IN MM (AUSNAHME HTA UND STA IN °)

- STL** SEAT TUBE LENGTH
SITZROHRLÄNGE
- CSL** CHAINSTAY LENGTH
KETTENSTREBENLÄNGE
- TTL** TOP TUBE LENGTH
OBERROHRLÄNGE
- HTL** HEAD TUBE LENGTH
STEUERROHRLÄNGE
- HTA** HEAD TUBE ANGLE
STEUERROHRWINKEL
- STA** SEAT TUBE ANGLE
SITZROHRWINKEL
- BB** BOTTOM BRACKET DROP
INNENLAGERABSENKUNG
- WB** WHEELBASE
RADSTAND
- ST** STACK
STACK
- RE** REACH
REACH
- SOH** STANDOVER HEIGHT
ÜBERSTANDSHÖHE
-  HEAD SET DIAMETER (UPPER / LOWER)
STEUERSATZDURCHMESSER (OBEN / UNTEN)

-  AXLE STANDARD (REAR / FRONT)
ACHSENSTANDARD (HINTEN / VORNE)
-  BOTTOM BRACKET STANDARD
TRETLAGERSTANDARD
-  SEAT POST DIAMETER
SATTELSTÜTZENDURCHMESSER
-  SHOCK HARDWARE (Ø 8 MM)
DÄMPFERBUCHSENMAßE (Ø 8 MM)
-  SHOCK LENGTH
DÄMPFERENBAULÄNGE
-  SHOCK TRAVEL
DÄMPFERHUB
-  FRONT FORK TRAVEL
FEDERWEG VORNE
-  REAR WHEEL TRAVEL
FEDERWEG HINTEN
-  STEM LENGTH
VORBAULÄNGE
-  HANDLEBAR WIDTH
LENKERBREITE
-  CRANK LENGTH
KURBELLÄNGE
-  SEAT TUBE BOTTLE MOUNT
FLASCHE SATTELROHR
-  DOWNTUBE BOTTLE MOUNT
FLASCHE UNTERROHR

	STL	CSL	TTL	HTL	HTA	STA	BB	WB	ST	RE	SOH																
E-TERU PRO EQ																											
XS	380	465	605	140	68	74	-65	1164	661	415	750	44 / 56	148/110	BOSCH BES3	34,9	- / -	0	0	100	0	80	720	165	-	0,75		
S	400	465	610	140	68	74	-60	1171	656	422	758	44 / 56	148/110	BOSCH BES3	34,9	- / -	0	0	100	0	80	740	165	-	0,75		
M	450	465	620	140	68	74	-60	1181	656	432	755	44 / 56	148/110	BOSCH BES3	34,9	- / -	0	0	100	0	80	740	165	-	0,75		
L	500	465	635	155	68	74	-60	1198	670	443	755	44 / 56	148/110	BOSCH BES3	34,9	- / -	0	0	100	0	80	740	170	-	0,75		
XL	550	465	658	170	68	74	-60	1223	684	462	790	44 / 56	148/110	BOSCH BES3	34,9	- / -	0	0	100	0	80	740	170	-	0,75		
E-TERU ADVANCED EQ																											
S	400	465	600	140	68	74	-60	1162	653	413	758	44 / 56	148/110	BOSCH BES3	34,9	- / -	0	0	100	0	80	720	165	-	0,75		
M	450	465	610	140	68	74	-60	1172	653	423	764	44 / 56	148/110	BOSCH BES3	34,9	- / -	0	0	100	0	80	740	165	-	0,75		
L	500	465	634	155	68	74	-60	1198	667	443	782	44 / 56	148/110	BOSCH BES3	34,9	- / -	0	0	100	0	80	740	170	-	0,75		
XL	550	465	658	170	68	74	-60	1223	681	463	814	44 / 56	148/110	BOSCH BES3	34,9	- / -	0	0	100	0	80	740	170	-	0,75		
XXL	600	465	680	180	68	74	-60	1246	690	482	846	44 / 56	148/110	BOSCH BES3	34,9	- / -	0	0	100	0	80	740	170	-	0,75		
E-TERU UNIVERSAL EQ HIGH																											
XS	380	465	605	140	68	74	-65	1164	661	415	680	44 / 56	148/110	BOSCH BES3	34,9	- / -	0	0	100	0	80	720	165	-	0,75		
S	400	465	610	140	68	74	-60	1171	656	422	689	44 / 56	148/110	BOSCH BES3	34,9	- / -	0	0	100	0	80	720	165	-	0,75		
M	450	465	620	140	68	74	-60	1181	656	432	679	44 / 56	148/110	BOSCH BES3	34,9	- / -	0	0	100	0	80	740	165	-	0,75		
L	500	465	635	155	68	74	-60	1198	670	443	670	44 / 56	148/110	BOSCH BES3	34,9	- / -	0	0	100	0	80	740	170	-	0,75		
XL	550	465	658	170	68	74	-60	1223	684	462	711	44 / 56	148/110	BOSCH BES3	34,9	- / -	0	0	100	0	80	740	170	-	0,75		

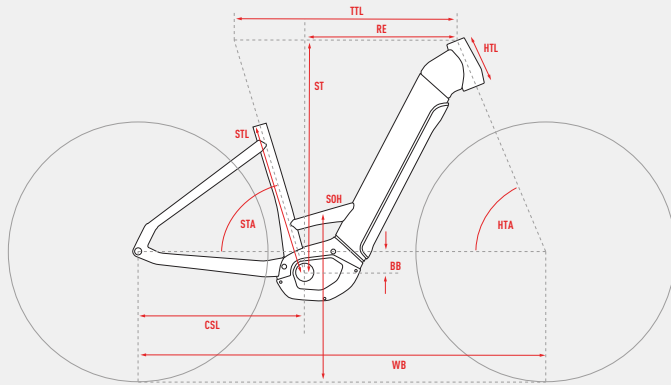

ALL DIMENSIONS IN MM (EXCEPT HTA AND STA IN °)

ALLE MAßE IN MM (AUSNAHME HTA UND STA IN °)

- STL** SEAT TUBE LENGTH
SITZROHRLÄNGE
- CSL** CHAINSTAY LENGTH
KETTENSTREBENLÄNGE
- TTL** TOP TUBE LENGTH
OBERROHRLÄNGE
- HTL** HEAD TUBE LENGTH
STEUERROHRLÄNGE
- HTA** HEAD TUBE ANGLE
STEUERROHRWINKEL
- STA** SEAT TUBE ANGLE
SITZROHRWINKEL
- BB** BOTTOM BRACKET DROP
INNENLAGERABSINKUNG
- WB** WHEELBASE
RADSTAND
- ST** STACK
STACK
- RE** REACH
REACH
- SOH** STANDOVER HEIGHT
ÜBERSTANDSHÖHE
- HEAD SET DIAMETER (UPPER / LOWER)
STEUERSATZDURCHMESSER (OBEN / UNTEN)

- AXLE STANDARD (REAR / FRONT)
ACHSENSTANDARD (HINTEN / VORNE)
- BOTTOM BRACKET STANDARD
TRETLAGERSTANDARD
- SEAT POST DIAMETER
SÄTTELSTÜTZENDURCHMESSER
- SHOCK HARDWARE (Ø 8 MM)
DÄMPFERBUCHSENMAßE (Ø 8 MM)
- SHOCK LENGTH
DÄMPFEREINBAULÄNGE
- SHOCK TRAVEL
DÄMPFERHÜB
- FRONT FORK TRAVEL
FEDERWEG VORNE
- REAR WHEEL TRAVEL
FEDERWEG HINTEN
- STEM LENGTH
VORBAULÄNGE
- HANDLEBAR WIDTH
LENKERBREITE
- CRANK LENGTH
KURBELLÄNGE
- SEAT TUBE BOTTLE MOUNT
FLASCHE SÄTTELROHR
- DOWNTUBE BOTTLE MOUNT
FLASCHE UNTERROHR

STL CSL TTL HTL HTA STA BB WB ST RE SOH

E-TERU PRO EQ LOW

S	380	475	610	150	69	74	-65	1167	659	421	478	44 / 56	148/110	BOSCH BES3	34,9	- / -	0	0	100	0	80	720	165	-	0,75
M	450	475	630	155	70	74	-60	1177	663	440	482	44 / 56	148/110	BOSCH BES3	34,9	- / -	0	0	100	0	80	740	165	-	0,75
L	500	475	660	175	70	74	-60	1209	682	464	474	44 / 56	148/110	BOSCH BES3	34,9	- / -	0	0	100	0	80	740	170	-	0,75

STL CSL TTL HTL HTA STA BB WB ST RE SOH

E-TERU ADVANCED EQ LOW

S	380	475	610	150	69	74	-65	1167	659	421	478	44 / 56	148/110	BOSCH BES3	34,9	- / -	0	0	100	0	80	720	165	-	0,75
M	450	475	630	155	70	74	-60	1177	663	440	482	44 / 56	148/110	BOSCH BES3	34,9	- / -	0	0	100	0	80	740	165	-	0,75
L	500	475	660	175	70	74	-60	1209	682	464	474	44 / 56	148/110	BOSCH BES3	34,9	- / -	0	0	100	0	80	740	170	-	0,75

STL CSL TTL HTL HTA STA BB WB ST RE SOH

E-TERU UNIVERSAL EQ LOW



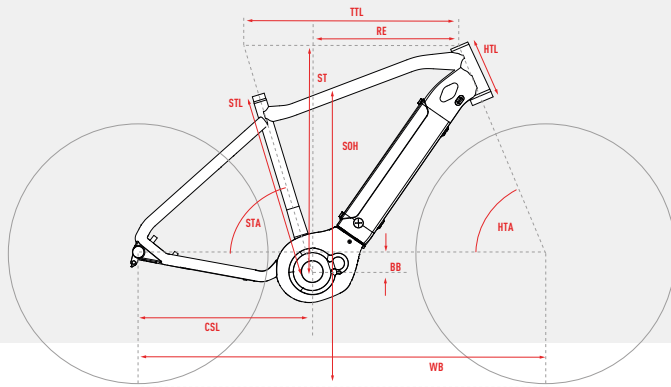











S	380	475	610	150	69	74	-65	1167	659	421	0	44 / 56	148/110	BOSCH BES3	34,9	- / -	0	0	100	0	80	720	165	-	0,75
M	450	475	630	155	70	74	-60	1177	663	440	0	44 / 56	148/110	BOSCH BES3	34,9	- / -	0	0	100	0	80	740	165	-	0,75
L	500	475	660	175	70	74	-60	1209	682	464	0	44 / 56	148/110	BOSCH BES3	34,9	- / -	0	0	100	0	80	740	170	-	0,75



ALL DIMENSIONS IN MM (EXCEPT HTA AND STA IN °)

ALLE MAßE IN MM (AUSNAHME HTA UND STA IN °)

- STL** SEAT TUBE LENGTH
SITZROHRLÄNGE
- CSL** CHAINSTAY LENGTH
KETTENSTREBENLÄNGE
- TTL** TOP TUBE LENGTH
OBERROHRLÄNGE
- HTL** HEAD TUBE LENGTH
STEUERROHRLÄNGE
- HTA** HEAD TUBE ANGLE
STEUERROHRWINKEL
- STA** SEAT TUBE ANGLE
SITZROHRWINKEL
- BB** BOTTOM BRACKET DROP
INNENLAGERABSENKUNG
- WB** WHEELBASE
RADSTAND
- ST** STACK
STACK
- RE** REACH
REACH
- SOH** STANDOVER HEIGHT
ÜBERSTANDSHÖHE
-  **HEAD SET DIAMETER (UPPER / LOWER)**
STEUERSATZDURCHMESSER (OBEN / UNTEN)
-  **AXLE STANDARD (REAR / FRONT)**
ACHSENSTANDARD (HINTEN / VORNE)
-  **BOTTOM BRACKET STANDARD**
TRETLAGERSTANDARD
-  **SEAT POST DIAMETER**
SÄTTELSTÜTZENDURCHMESSER
-  **SHOCK HARDWARE (Ø 8 MM)**
DÄMPFERBUCHSENMAßE (Ø 8 MM)
-  **SHOCK LENGTH**
DÄMPFEREINBAULÄNGE
-  **SHOCK TRAVEL**
DÄMPFERHÜB
-  **FRONT FORK TRAVEL**
FEDERWEG VORNE
-  **REAR WHEEL TRAVEL**
FEDERWEG HINTEN
-  **STEM LENGTH**
VORBAULÄNGE
-  **HANDLEBAR WIDTH**
LENKERBREITE
-  **CRANK LENGTH**
KURBELLÄNGE
-  **SEAT TUBE BOTTLE MOUNT**
FLASCHE SÄTTELROHR
-  **DOWNTUBE BOTTLE MOUNT**
FLASCHE UNTERROHR

	STL	CSL	TTL	HTL	HTA	STA	BB	WB	ST	RE	SOH																
E-TERU ESSENTIAL																											
S	400	490	574	125	65	74.8	54	1217	624	405	704	44 / 56	148/110	BOSCH BES3	31,6	- / -	0	0	120	0	45	700	165	0,5	-		
M	450	495	606	120	65	74.6	69	1251	653	427	742	44 / 56	148/110	BOSCH BES3	31,6	- / -	0	0	120	0	45	720	165	0,75	-		
L	490	495	639	135	65	74.6	64	1287	661	456	765	44 / 56	148/110	BOSCH BES3	31,6	- / -	0	0	120	0	45	740	170	0,75	-		
XL	530	495	671	160	65	74.6	64	1323	683	482	804	44 / 56	148/110	BOSCH BES3	31,6	- / -	0	0	120	0	45	760	170	0,75	-		
E-TERU ESSENTIAL EQ HIGH																											
S	480	490	545	155	67	73	55	1176	622	397	754	44 / 56	148/110	BOSCH BES3	31,6	- / -	0	0	80	0	45	700	165	0,5	-		
M	520	490	575	170	67	73	55	1198	636	414	797	44 / 56	148/110	BOSCH BES3	31,6	- / -	0	0	80	0	45	720	165	0,5	-		
L	560	490	604	180	67	73	55	1224	645	436	801	44 / 56	148/110	BOSCH BES3	31,6	- / -	0	0	80	0	45	740	170	0,75	-		
XL	600	490	635	190	67	73	55	1250	655	458	832	44 / 56	148/110	BOSCH BES3	31,6	- / -	0	0	80	0	45	740	170	0,75	-		

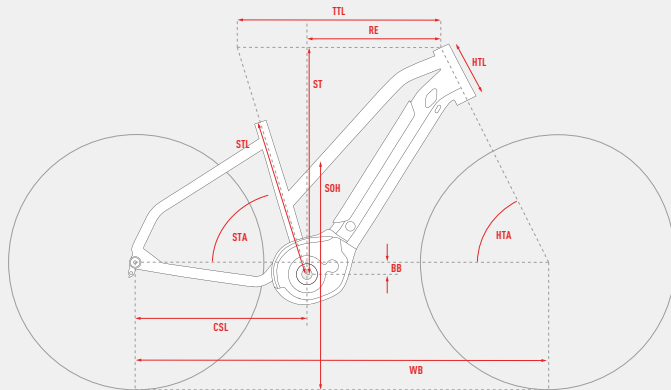













ALL DIMENSIONS IN MM (EXCEPT HTA AND STA IN °)

ALLE MAßE IN MM (AUSNAHME HTA UND STA IN °)













- STL** SEAT TUBE LENGTH
SITZROHRLÄNGE
- CSL** CHAINSTAY LENGTH
KETTENSTREBENLÄNGE
- TTL** TOP TUBE LENGTH
OBERROHRLÄNGE
- HTL** HEAD TUBE LENGTH
STEUERROHRLÄNGE
- HTA** HEAD TUBE ANGLE
STEUERROHRWINKEL
- STA** SEAT TUBE ANGLE
SITZROHRWINKEL
- BB** BOTTOM BRACKET DROP
INNENLAGERABSENKUNG
- WB** WHEELBASE
RADSTAND
- ST** STACK
STACK
- RE** REACH
REACH
- SOH** STANDOVER HEIGHT
ÜBERSTANDSHÖHE
-  **HEAD SET DIAMETER (UPPER / LOWER)**
STEUERSATZDURCHMESSER (OBEN / UNTEN)

-  **AXLE STANDARD (REAR / FRONT)**
ACHSENSTANDARD (HINTEN / VORNE)
-  **BOTTOM BRACKET STANDARD**
TRETLAGERSTANDARD
-  **SEAT POST DIAMETER**
SÄTTELSTÜTZENDURCHMESSER
-  **SHOCK HARDWARE (Ø 8 MM)**
DÄMPFERBUCHSENMAßE (Ø 8 MM)
-  **SHOCK LENGTH**
DÄMPFEREINBAULÄNGE
-  **SHOCK TRAVEL**
DÄMPFERHÜB
-  **FRONT FORK TRAVEL**
FEDERWEG VORNE
-  **REAR WHEEL TRAVEL**
FEDERWEG HINTEN
-  **STEM LENGTH**
VORBAULÄNGE
-  **HANDLEBAR WIDTH**
LENKERBREITE
-  **CRANK LENGTH**
KURBELLÄNGE
-  **SEAT TUBE BOTTLE MOUNT**
FLASCHE SÄTTELROHR
-  **DOWNTUBE BOTTLE MOUNT**
FLASCHE UNTERROHR

STL CSL TTL HTL HTA STA BB WB ST RE SOH            

E-TERU ESSENTIAL EQ MID

S	440	490	580	155	67	73	55	1169	622	390	601	44 / 56	148/110	BOSCH BES3	31,6	- / -	0	0	80	0	45	720	170	-	-
M	480	490	595	170	67	73	55	1184	636	400	601	44 / 56	148/110	BOSCH BES3	31,6	- / -	0	0	80	0	45	740	175	-	-
L	520	490	613	190	67	73	55	1205	655	413	600	44 / 56	148/110	BOSCH BES3	31,6	- / -	0	0	80	0	45	740	175	-	-

STL CSL TTL HTL HTA STA BB WB ST RE SOH            

E-TERU

XS	370	490	574	125	65	74.8	54	1217	624	405	620	44 / 56	148/110	BOSCH BES3	31,6	- / -	0	0	120	0	45	700	165	-	-
----	-----	-----	-----	-----	----	------	----	------	-----	-----	-----	---------	---------	------------	------	-------	---	---	-----	---	----	-----	-----	---	---



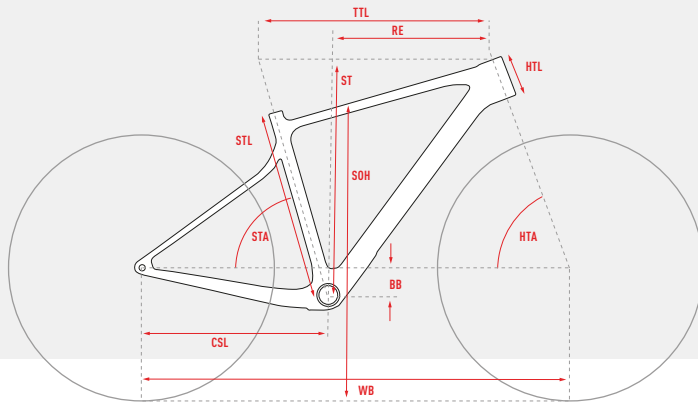









ASKET

















ALL DIMENSIONS IN MM (EXCEPT HTA AND STA IN °)

ALLE MADE IN MM (AUSNAHME HTA UND STA IN °)

- STL** SEAT TUBE LENGTH
SITZROHRLÄNGE
- CSL** CHAINSTAY LENGTH
KETTENSTREBENLÄNGE
- TTL** TOP TUBE LENGTH
OBERROHRLÄNGE
- HTL** HEAD TUBE LENGTH
STEUERROHRLÄNGE
- HTA** HEAD TUBE ANGLE
STEUERROHRWINKEL
- STA** SEAT TUBE ANGLE
SITZROHRWINKEL
- BB** BOTTOM BRACKET DROP
INNENLAGERABSENKUNG
- WB** WHEELBASE
RADSTAND
- ST** STACK
STACK
- RE** REACH
REACH
- SOH** STANDOVER HEIGHT
ÜBERSTANDSHÖHE
-  HEAD SET DIAMETER (UPPER / LOWER)
STEUERSATZDURCHMESSER (OBEN / UNTEN)

-  AXLE STANDARD (REAR / FRONT)
ACHSENSTANDARD (HINTEN / VORNE)
-  BOTTOM BRACKET STANDARD
TRETLAGERSTANDARD
-  SEAT POST DIAMETER
SATTELSTÜTZENDURCHMESSER
-  SHOCK HARDWARE (Ø 8 MM)
DÄMPFERBUCHSENMAßE (Ø 8 MM)
-  SHOCK LENGTH
DÄMPFERENBAULÄNGE
-  SHOCK TRAVEL
DÄMPFERHUB
-  FRONT FORK TRAVEL
FEDERWEG VORNE
-  REAR WHEEL TRAVEL
FEDERWEG HINTEN
-  STEM LENGTH
VORBAULÄNGE
-  HANDLEBAR WIDTH
LENKERBREITE
-  CRANK LENGTH
KURBELLÄNGE
-  SEAT TUBE BOTTLE MOUNT
FLASCHE SATTELROHR
-  DOWNTUBE BOTTLE MOUNT
FLASCHE UNTERROHR

	STL	CSL	TTL	HTL	HTA	STA	BB	WB	ST	RE	SOH																
ASKET CF "30"																											
XS	440	430	526	95	69	74	62.5	1044	542	375	750	52 / 52	142/100	PF86	27,2	- / -	0	0	40	0	70	420	170	0,75	0,75		
S	470	430	544	115	69	74	62.5	1063	560	387	775	52 / 52	142/100	PF86	27,2	- / -	0	0	40	0	70	420	170	0,75	0,75		
M	500	435	564	135	69.5	74	62.5	1084	581	400	800	52 / 52	142/100	PF86	27,2	- / -	0	0	40	0	70	440	172,5	0,75	0,75		
L	530	435	590	165	70	74	62.5	1107	612	417	829	52 / 52	142/100	PF86	27,2	- / -	0	0	40	0	70	460	172,5	0,75	0,75		
XL	560	440	624	195	70.5	74	62.5	1142	642	443	858	52 / 52	142/100	PF86	27,2	- / -	0	0	40	0	70	460	175	0,75	0,75		
ASKET CF FULL PARTY																											
XS	440	430	526	95	69	74	62.5	1044	542	375	750	52 / 52	142/100	PF86	27,2	- / -	0	0	40	0	70	420	170	0,75	0,75		
S	470	430	544	115	69	74	62.5	1063	560	387	775	52 / 52	142/100	PF86	27,2	- / -	0	0	40	0	70	440	170	0,75	0,75		
M	500	435	564	135	69.5	74	62.5	1084	581	400	800	52 / 52	142/100	PF86	27,2	- / -	0	0	40	0	70	460	172,5	0,75	0,75		
L	530	435	590	165	70	74	62.5	1107	612	418	829	52 / 52	142/100	PF86	27,2	- / -	0	0	40	0	70	480	172,5	0,75	0,75		
XL	560	440	624	195	70.5	74	62.5	1142	642	443	858	52 / 52	142/100	PF86	27,2	- / -	0	0	40	0	70	500	175	0,75	0,75		
ASKET CF PRO																											
XS	440	430	526	95	69	74	62.5	1044	542	375	750	52 / 52	142/100	PF86	27,2	- / -	0	0	0	0	70	420	170	0,75	0,75		
S	470	430	544	115	69	74	62.5	1063	560	387	775	52 / 52	142/100	PF86	27,2	- / -	0	0	0	0	70	440	170	0,75	0,75		
M	500	435	564	135	69.5	74	62.5	1084	581	400	800	52 / 52	142/100	PF86	27,2	- / -	0	0	0	0	70	460	172,5	0,75	0,75		
L	530	435	590	165	70	74	62.5	1107	612	418	829	52 / 52	142/100	PF86	27,2	- / -	0	0	0	0	70	480	172,5	0,75	0,75		
XL	560	440	624	195	70.5	74	62.5	1142	642	443	858	52 / 52	142/100	PF86	27,2	- / -	0	0	0	0	70	500	175	0,75	0,75		

ASKET

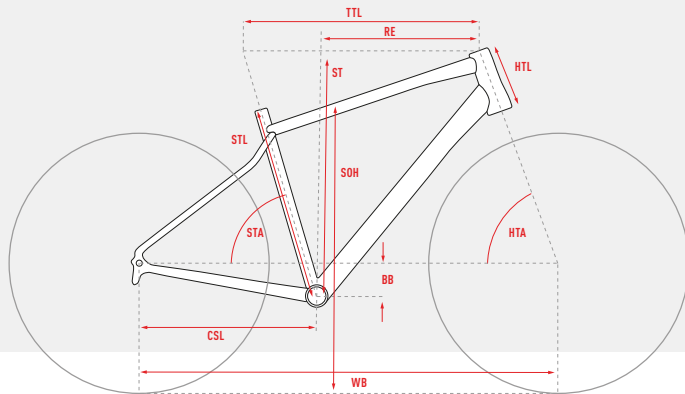

ALL DIMENSIONS IN MM (EXCEPT HTA AND STA IN °)

ALLE MADE IN MM (AUSNAHME HTA UND STA IN °)

- STL** SEAT TUBE LENGTH
SITZROHRLÄNGE
- CSL** CHAINSTAY LENGTH
KETTENSTREBENLÄNGE
- TTL** TOP TUBE LENGTH
OBERROHRLÄNGE
- HTL** HEAD TUBE LENGTH
STEUERROHRLÄNGE
- HTA** HEAD TUBE ANGLE
STEUERROHRWINKEL
- STA** SEAT TUBE ANGLE
SITZROHRWINKEL
- BB** BOTTOM BRACKET DROP
INNENLAGERABSENKUNG
- WB** WHEELBASE
RADSTAND
- ST** STACK
STACK
- RE** REACH
REACH
- SOH** STANDOVER HEIGHT
ÜBERSTANDSHÖHE
- HEAD SET DIAMETER (UPPER / LOWER)
STEUERSATZDURCHMESSER (OBEN / UNTEN)

- AXLE STANDARD (REAR / FRONT)
ACHSENSTANDARD (HINTEN / VORNE)
- BOTTOM BRACKET STANDARD
TRETLAGERSTANDARD
- SEAT POST DIAMETER
SÄTTELSTÜTZENDURCHMESSER
- SHOCK HARDWARE (Ø 8 MM)
DÄMPFERBUCHSENMAßE (Ø 8 MM)
- SHOCK LENGTH
DÄMPFERENBAULÄNGE
- SHOCK TRAVEL
DÄMPFERHUB
- FRONT FORK TRAVEL
FEDERWEG VORNE
- REAR WHEEL TRAVEL
FEDERWEG HINTEN
- STEM LENGTH
VORBAULÄNGE
- HANDLEBAR WIDTH
LENKERBREITE
- CRANK LENGTH
KURBELLÄNGE
- SEAT TUBE BOTTLE MOUNT
FLASCHE SÄTTELROHR
- DOWNTUBE BOTTLE MOUNT
FLASCHE UNTERROHR

	STL	CSL	TTL	HTL	HTA	STA	BB	WB	ST	RE	SOH															
ASKET ADVANCED EQ																										
XS	410	440	535	100	69.5	73.8	71.6	1049	558	373	680	44 / 56	142/100	BSA68	27,2	- / -	0	0	0	0	0	60	420	170	0,5	0,6
S	450	440	563	130	69.8	73.7	71.5	1076	587	392	710	44 / 56	142/100	BSA68	27,2	- / -	0	0	0	0	0	60	440	170	0,6	0,6
M	485	440	586	160	70.1	73.7	66.5	1098	612	407	750	44 / 56	142/100	BSA68	27,2	- / -	0	0	0	0	0	60	460	172,5	0,75	0,75
L	525	440	615	190	70.4	73.6	66.5	1126	641	427	780	44 / 56	142/100	BSA68	27,2	- / -	0	0	0	0	0	60	480	175	0,75	0,75
XL	560	440	639	220	70.7	73.6	61.5	1150	666	444	820	44 / 56	142/100	BSA68	27,2	- / -	0	0	0	0	0	60	500	175	0,75	0,75
ASKET ESSENTIAL EQ																										
XS	410	440	535	100	69.5	73.8	71.6	1049	558	373	680	44 / 56	142/100	BSA68	27,2	- / -	0	0	0	0	0	60	420	170	0,5	0,6
S	450	440	563	130	69.8	73.7	71.5	1076	587	392	710	44 / 56	142/100	BSA68	27,2	- / -	0	0	0	0	0	60	440	170	0,6	0,6
M	485	440	586	160	70.1	73.7	66.5	1098	612	407	750	44 / 56	142/100	BSA68	27,2	- / -	0	0	0	0	0	60	460	172,5	0,75	0,75
L	525	440	615	190	70.4	73.6	66.5	1126	641	427	780	44 / 56	142/100	BSA68	27,2	- / -	0	0	0	0	0	60	480	175	0,75	0,75
XL	560	440	639	220	70.7	73.6	61.5	1150	666	444	820	44 / 56	142/100	BSA68	27,2	- / -	0	0	0	0	0	60	500	175	0,75	0,75
ASKET EQ																										
XS	410	440	535	100	69.5	73.8	71.6	1049	558	373	680	44 / 56	142/100	BSA68	27,2	- / -	0	0	0	0	0	60	420	170	0,5	0,6
S	450	440	563	130	69.8	73.7	71.5	1076	587	392	710	44 / 56	142/100	BSA68	27,2	- / -	0	0	0	0	0	60	440	170	0,6	0,6
M	485	440	586	160	70.1	73.7	66.5	1098	612	407	750	44 / 56	142/100	BSA68	27,2	- / -	0	0	0	0	0	60	460	172,5	0,75	0,75
L	525	440	615	190	70.4	73.6	66.5	1126	641	427	780	44 / 56	142/100	BSA68	27,2	- / -	0	0	0	0	0	60	480	175	0,75	0,75
XL	560	440	639	220	70.7	73.6	61.5	1150	666	444	820	44 / 56	142/100	BSA68	27,2	- / -	0	0	0	0	0	60	500	175	0,75	0,75

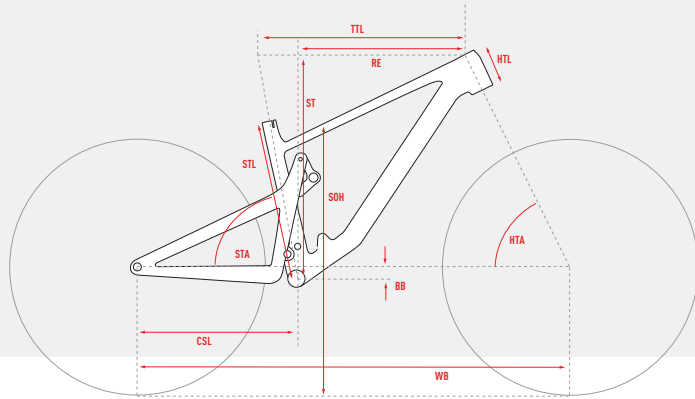

ALL DIMENSIONS IN MM (EXCEPT HTA AND STA IN °)

ALLE MAÛE IN MM (AUSNAHME HTA UND STA IN °)

- STL** SEAT TUBE LENGTH
SITZROHRLÄNGE
- CSL** CHAINSTAY LENGTH
KETTENSTREBENLÄNGE
- TTL** TOP TUBE LENGTH
OBERROHRLÄNGE
- HTL** HEAD TUBE LENGTH
STEUERROHRLÄNGE
- HTA** HEAD TUBE ANGLE
STEUERROHRWINKEL
- STA** SEAT TUBE ANGLE
SITZROHRWINKEL
- BB** BOTTOM BRACKET DROP
INNENLAGERABSENKUNG
- WB** WHEELBASE
RADSTAND
- ST** STACK
STACK
- RE** REACH
REACH
- SOH** STANDOVER HEIGHT
ÜBERSTANDSHÖHE
- HEAD SET DIAMETER (UPPER / LOWER)
STEUERSATZDURCHMESSER (OBEN / UNTEN)

- AXLE STANDARD (REAR / FRONT)
ACHSENSTANDARD (HINTEN / VORNE)
- BOTTOM BRACKET STANDARD
TRETLAGERSTANDARD
- SEAT POST DIAMETER
SÄTTELSTÜTZENDURCHMESSER
- SHOCK HARDWARE (Ø 8 MM)
DÄMPFERBUCHSENMAÛE (Ø 8 MM)
- SHOCK LENGTH
DÄMPFERENBAULÄNGE
- SHOCK TRAVEL
DÄMPFERHUB
- FRONT FORK TRAVEL
FEDERWEG VORNE
- REAR WHEEL TRAVEL
FEDERWEG HINTEN
- STEM LENGTH
VORBAULÄNGE
- HANDLEBAR WIDTH
LENKERBREITE
- CRANK LENGTH
KURBELLÄNGE
- SEAT TUBE BOTTLE MOUNT
FLASCHE SÄTTELROHR
- DOWNTUBE BOTTLE MOUNT
FLASCHE UNTERROHR

	STL	CSL	TTL	HTL	HTA	STA	BB	WB	ST	RE	SOH														
RIOT AM FULL PARTY																									
S	417	446	581	90	63.5	76.5	34.2	1224	607	435	746	44 / 56	148/110	BSA 73	34,9	Trunnion / 30x10	185	55	160	140	40	760	170	-	0,5
M	441	446	615	110	63.5	76.5	34.3	1263	626	465	753	44 / 56	148/110	BSA 73	34,9	Trunnion / 30x10	185	55	160	140	40	800	170	-	0,75
L	465	455	647	140	63.5	76.5	29.5	1312	648	492	775	44 / 56	148/110	BSA 73	34,9	Trunnion / 30x10	185	55	160	140	40	800	175	-	0,75
XL	489	455	681	160	63.5	76.5	29.6	1350	666	522	793	44 / 56	148/110	BSA 73	34,9	Trunnion / 30x10	185	55	160	140	40	800	175	-	0,75
RIOT AM PRO																									
S	417	446	581	90	63.5	76.5	34.2	1224	607	435	746	44 / 56	148/110	BSA 73	34,9	Trunnion / 30x10	185	55	160	140	40	760	170	-	0,5
M	441	446	615	110	63.5	76.5	34.3	1263	626	465	753	44 / 56	148/110	BSA 73	34,9	Trunnion / 30x10	185	55	160	140	40	800	170	-	0,75
L	465	455	647	140	63.5	76.5	29.5	1312	648	492	778	44 / 56	148/110	BSA 73	34,9	Trunnion / 30x10	185	55	160	140	40	800	175	-	0,75
XL	489	455	681	160	63.5	76.5	29.6	1350	666	522	796	44 / 56	148/110	BSA 73	34,9	Trunnion / 30x10	185	55	160	140	40	800	175	-	0,75
RIOT TRAIL FULL PARTY																									
S	417	446	580	90	64	77	38.1	1219	604	441	742	44 / 56	148/110	BSA 73	34,9	Trunnion / 30x10	185	55	150	140	40	760	170	-	0,5
M	441	446	614	110	64	77	38.1	1258	622	471	749	44 / 56	148/110	BSA 73	34,9	Trunnion / 30x10	185	55	150	140	40	800	170	-	0,75
L	465	455	646	140	64	77	33.3	1307	644	497	775	44 / 56	148/110	BSA 73	34,9	Trunnion / 30x10	185	55	150	140	40	800	175	-	0,75
XL	489	455	678	160	64	77	33.3	1346	662	527	793	44 / 56	148/110	BSA 73	34,9	Trunnion / 30x10	185	55	150	140	40	800	175	-	0,75
RIOT TRAIL PRO																									
S	417	446	580	90	64	77	38.1	1219	604	441	742	44 / 56	148/110	BSA 73	34,9	Trunnion / 30x10	185	55	150	140	40	760	170	-	0,5
M	441	446	614	110	64	77	38.1	1258	622	471	749	44 / 56	148/110	BSA 73	34,9	Trunnion / 30x10	185	55	150	140	40	800	170	-	0,75
L	465	455	646	140	64	77	33.3	1307	644	497	775	44 / 56	148/110	BSA 73	34,9	Trunnion / 30x10	185	55	150	140	40	800	175	-	0,75
XL	489	455	679	160	64	77	33.3	1346	662	527	793	44 / 56	148/110	BSA 73	34,9	Trunnion / 30x10	185	55	150	140	40	800	175	-	0,75

LECTOR FS

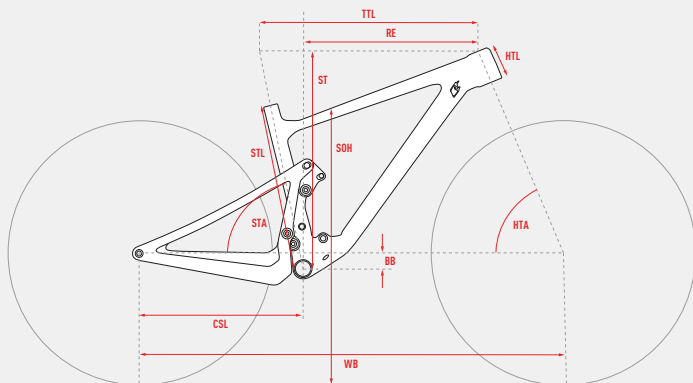

ALL DIMENSIONS IN MM (EXCEPT HTA AND STA IN °)

ALLE MAßE IN MM (AUSNAHME HTA UND STA IN °)

- STL** SEAT TUBE LENGTH
SITZROHRLÄNGE
- CSL** CHAINSTAY LENGTH
KETTENSTREBENLÄNGE
- TTL** TOP TUBE LENGTH
OBERROHRLÄNGE
- HTL** HEAD TUBE LENGTH
STEUERROHRLÄNGE
- HTA** HEAD TUBE ANGLE
STEUERROHRWINKEL
- STA** SEAT TUBE ANGLE
SITZROHRWINKEL
- BB** BOTTOM BRACKET DROP
INNENLAGERABSENKUNG
- WB** WHEELBASE
RADSTAND
- ST** STACK
STACK
- RE** REACH
REACH
- SOH** STANDOVER HEIGHT
ÜBERSTANDSHÖHE
- HEAD SET DIAMETER (UPPER / LOWER)
STEUERSATZDURCHMESSER (OBEN / UNTEN)

- AXLE STANDARD (REAR / FRONT)
ACHSENSTANDARD (HINTEN / VORNE)
- BOTTOM BRACKET STANDARD
TRETLAGERSTANDARD
- SEAT POST DIAMETER
SATTELSTÜTZENDURCHMESSER
- SHOCK HARDWARE (Ø 8 MM)
DÄMPFERBUCHSENMAßE (Ø 8 MM)
- SHOCK LENGTH
DÄMPFERENBAULÄNGE
- SHOCK TRAVEL
DÄMPFERHUB
- FRONT FORK TRAVEL
FEDERWEG VORNE
- REAR WHEEL TRAVEL
FEDERWEG HINTEN
- STEM LENGTH
VORBAULÄNGE
- HANDLEBAR WIDTH
LENKERBREITE
- CRANK LENGTH
KURBELLÄNGE
- SEAT TUBE BOTTLE MOUNT
FLASCHE SATTELROHR
- DOWNTUBE BOTTLE MOUNT
FLASCHE UNTERROHR

STL CSL TTL HTL HTA STA BB WB ST RE SOH

LECTOR FS WORLD CUP "30"

	STL	CSL	TTL	HTL	HTA	STA	BB	WB	ST	RE	SOH														
XS	417	435	575	90	67.4	74.9	40.6	1128	581	418	715	42 / 56	148/110	PF 92 dub	34,9	30x10 / 54xTR	165	40	110	110	50	760	170	-	0,75
S	441	435	603	90	67.4	74.9	40.6	1168	582	458	735	42 / 56	148/110	PF 92 dub	34,9	30x10 / 54xTR	165	40	110	110	50	760	170	0,5	0,75
M	465	440	649	100	68	75.5	32.6	1214	601	489	760	42 / 56	148/110	PF 92 dub	34,9	30x10 / 54xTR	165	45	120	120	50	760	170	0,75	0,75
L	489	440	669	120	68	75.5	32.6	1241	618	507	770	42 / 56	148/110	PF 92 dub	34,9	30x10 / 54xTR	165	45	120	120	50	760	175	0,75	0,75
XL	513	440	701	140	68	75.5	32.6	1275	636	533	780	42 / 56	148/110	PF 92 dub	34,9	30x10 / 54xTR	165	45	120	120	50	760	175	0,75	0,75

STL CSL TTL HTL HTA STA BB WB ST RE SOH

LECTOR FS PRO

	STL	CSL	TTL	HTL	HTA	STA	BB	WB	ST	RE	SOH														
XS	417	435	575	90	68	75.5	41	1130	577	424	710	44 / 56	148/110	PF92 / DUB	34,9	30x10 / 54xTR	165	40	100	100	45	700	170	0,5	0,75
S	441	435	603	90	68	75.5	41	1161	575	453	730	44 / 56	148/110	PF92 / DUB	34,9	30x10 / 54xTR	165	40	100	100	45	720	170	0,5	0,75
M	465	440	649	100	68	75.5	33	1214	601	489	760	44 / 56	148/110	PF92 / DUB	34,9	30x10 / 54xTR	165	45	120	120	45	740	170	0,75	0,75
L	489	440	669	120	68	75.5	33	1241	618	507	770	44 / 56	148/110	PF92 / DUB	34,9	30x10 / 54xTR	165	45	120	120	45	740	175	0,75	0,75
XL	513	440	701	140	68	75.5	33	1275	636	533	780	44 / 56	148/110	PF92 / DUB	34,9	30x10 / 54xTR	165	45	120	120	45	760	175	0,75	0,75

STL CSL TTL HTL HTA STA BB WB ST RE SOH

LECTOR FS ADVANCED

	STL	CSL	TTL	HTL	HTA	STA	BB	WB	ST	RE	SOH														
XS	417	435	575	90	68	75.5	41	1130	577	424	710	44 / 56	148/110	PF92 / DUB	34,9	30x10 / 54xTR	165	40	100	100	45	700	170	0,5	0,75
S	441	435	603	90	68	75.5	41	1161	575	453	730	44 / 56	148/110	PF92 / DUB	34,9	30x10 / 54xTR	165	40	100	100	45	720	170	0,5	0,75
M	465	440	649	100	68	75.5	33	1214	601	489	760	44 / 56	148/110	PF92 / DUB	34,9	30x10 / 54xTR	165	45	120	120	45	740	170	0,75	0,75
L	489	440	669	120	68	75.5	33	1241	618	507	770	44 / 56	148/110	PF92 / DUB	34,9	30x10 / 54xTR	165	45	120	120	45	740	175	0,75	0,75
XL	513	440	701	140	68	75.5	33	1275	636	533	780	44 / 56	148/110	PF92 / DUB	34,9	30x10 / 54xTR	165	45	120	120	45	760	175	0,75	0,75

STL CSL TTL HTL HTA STA BB WB ST RE SOH

LECTOR FS ESSENTIAL

	STL	CSL	TTL	HTL	HTA	STA	BB	WB	ST	RE	SOH														
XS	417	435	575	90	68	75.5	41	1130	577	424	710	44 / 56	148/110	PF92 / DUB	34,9	30x10 / 54xTR	165	40	100	100	45	700	170	0,5	0,75
S	441	435	603	90	68	75.5	41	1161	575	453	730	44 / 56	148/110	PF92 / DUB	34,9	30x10 / 54xTR	165	40	100	100	45	720	170	0,5	0,75
M	465	440	649	100	68	75.5	33	1214	601	489	760	44 / 56	148/110	PF92 / DUB	34,9	30x10 / 54xTR	165	45	120	120	45	740	170	0,75	0,75
L	489	440	669	120	68	75.5	33	1241	618	507	770	44 / 56	148/110	PF92 / DUB	34,9	30x10 / 54xTR	165	45	120	120	45	740	175	0,75	0,75
XL	513	440	701	140	68	75.5	33	1275	636	533	780	44 / 56	148/110	PF92 / DUB	34,9	30x10 / 54xTR	165	45	120	120	45	760	175	0,75	0,75



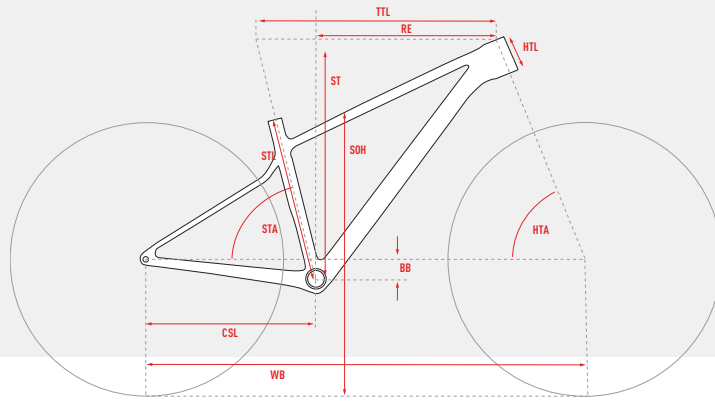









LECTOR

















ALL DIMENSIONS IN MM (EXCEPT HTA AND STA IN °)

ALLE MAÛE IN MM (AUSNAHME HTA UND STA IN °)

- STL** SEAT TUBE LENGTH
SITZROHRLÄNGE
- CSL** CHAINSTAY LENGTH
KETTENSTREBELÄNGE
- TTL** TOP TUBE LENGTH
OBERROHRLÄNGE
- HTL** HEAD TUBE LENGTH
STEUERROHRLÄNGE
- HTA** HEAD TUBE ANGLE
STEUERROHRWINKEL
- STA** SEAT TUBE ANGLE
SITZROHRWINKEL
- BB** BOTTOM BRACKET DROP
INNENLAGERABSINKUNG
- WB** WHEELBASE
RADSTAND
- ST** STACK
STACK
- RE** REACH
REACH
- SOH** STANDOVER HEIGHT
ÜBERSTANDSHÖHE
-  HEAD SET DIAMETER (UPPER / LOWER)
STEUERSATZDURCHMESSER (OBEN / UNTEN)

-  AXLE STANDARD (REAR / FRONT)
ACHSENSTANDARD (HINTEN / VORNE)
-  BOTTOM BRACKET STANDARD
TRETLAGERSTANDARD
-  SEAT POST DIAMETER
SITZELSTÜTZENDURCHMESSER
-  SHOCK HARDWARE (Ø 8 MM)
DÄMPFERBUCHSENMAÛE (Ø 8 MM)
-  SHOCK LENGTH
DÄMPFERBAULÄNGE
-  SHOCK TRAVEL
DÄMPFERHUB
-  FRONT FORK TRAVEL
FEDERWEG VORNE
-  REAR WHEEL TRAVEL
FEDERWEG HINTEN
-  STEM LENGTH
VORBAULÄNGE
-  HANDLEBAR WIDTH
LENKERBREITE
-  CRANK LENGTH
KURBELLÄNGE
-  SEAT TUBE BOTTLE MOUNT
FLASCHE SITZELROHR
-  DOWNTUBE BOTTLE MOUNT
FLASCHE UNTERROHR

	STL	CSL	TTL	HTL	HTA	STA	BB	WB	ST	RE	SOH																
LECTOR WORLD CUP "30"																											
XS	405	430	567	90	68	75.8	60	1112	611	412	759	42 / 56	148/110	PF 92 dub	31,6	- / -	0	0	110	0	65	780	170	0,5	0,75		
S	425	430	603	90	68	75.7	60	1148	611	448	762	42 / 56	148/110	PF 92 dub	31,6	- / -	0	0	110	0	65	780	170	0,75	0,75		
M	445	430	639	90	68	75.7	60	1184	611	484	767	42 / 56	148/110	PF 92 dub	31,6	- / -	0	0	110	0	65	780	170	0,75	0,75		
L	465	430	671	110	68	75.7	55	1221	634	510	787	42 / 56	148/110	PF 92 dub	31,6	- / -	0	0	120	0	65	780	175	0,75	0,75		
XL	485	430	704	140	68	75.7	55	1258	661	535	795	42 / 56	148/110	PF 92 dub	31,6	- / -	0	0	120	0	65	780	175	0,75	0,75		
LECTOR PRO																											
XS	405	430	568	90	68	75.8	60	1112	611	412	759	42 / 56	148/110	PF 92 dub	31,6	- / -	0	0	110	0	50	760	170	0,5	0,75		
S	425	430	603	90	68	75.7	60	1148	611	448	762	42 / 56	148/110	PF 92 dub	31,6	- / -	0	0	110	0	50	760	170	0,75	0,75		
M	445	430	639	90	68	75.7	60	1184	611	484	767	42 / 56	148/110	PF 92 dub	31,6	- / -	0	0	110	0	50	760	170	0,75	0,75		
L	465	430	671	110	68	75.7	55	1221	634	510	787	42 / 56	148/110	PF 92 dub	31,6	- / -	0	0	120	0	50	760	175	0,75	0,75		
XL	485	430	704	140	68	75.7	55	1258	661	535	795	42 / 56	148/110	PF 92 dub	31,6	- / -	0	0	120	0	50	760	175	0,75	0,75		
LECTOR ADVANCED																											
XS	405	430	567	90	68	75.8	60	1112	611	412	759	42 / 56	148/110	PF 92 dub	31,6	- / -	0	0	110	0	45	760	170	0,5	0,75		
S	425	430	603	90	68	75.7	60	1148	611	448	762	42 / 56	148/110	PF 92 dub	31,6	- / -	0	0	110	0	45	760	170	0,75	0,75		
M	445	430	639	90	68	75.7	60	1184	611	484	767	42 / 56	148/110	PF 92 dub	31,6	- / -	0	0	110	0	45	760	170	0,75	0,75		
L	465	430	671	110	68	75.7	55	1221	634	510	787	42 / 56	148/110	PF 92 dub	31,6	- / -	0	0	120	0	45	760	175	0,75	0,75		
XL	485	430	704	140	68	75.7	55	1258	661	535	795	42 / 56	148/110	PF 92 dub	31,6	- / -	0	0	120	0	45	760	175	0,75	0,75		
LECTOR UNIVERSAL																											
XS	405	430	567	90	68	75.8	60	1112	611	412	759	42 / 56	148/110	PF 92 dub	31,6	- / -	0	0	110	0	45	760	170	0,5	0,75		
S	425	430	603	90	68	75.7	60	1148	611	448	762	42 / 56	148/110	PF 92 dub	31,6	- / -	0	0	110	0	45	760	170	0,75	0,75		
M	445	430	639	90	68	75.7	60	1184	611	484	767	42 / 56	148/110	PF 92 dub	31,6	- / -	0	0	110	0	45	760	170	0,75	0,75		
L	465	430	671	110	68	75.7	55	1221	634	510	787	42 / 56	148/110	PF 92 dub	31,6	- / -	0	0	120	0	45	760	175	0,75	0,75		
XL	485	430	704	140	68	75.7	55	1258	661	535	795	42 / 56	148/110	PF 92 dub	31,6	- / -	0	0	120	0	45	760	175	0,75	0,75		

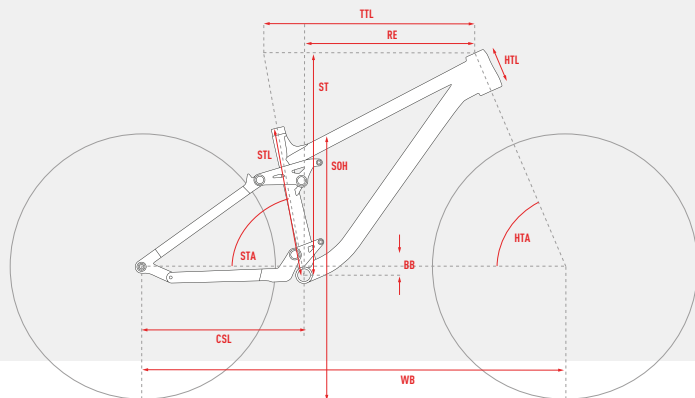

ALL DIMENSIONS IN MM (EXCEPT HTA AND STA IN °)

ALLE MAÛE IN MM (AUSNAHME HTA UND STA IN °)

- STL** SEAT TUBE LENGTH
SITZROHRLÄNGE
- CSL** CHAINSTAY LENGTH
KETTENSTREBELÄNGE
- TTL** TOP TUBE LENGTH
OBERROHRLÄNGE
- HTL** HEAD TUBE LENGTH
STEUERROHRLÄNGE
- HTA** HEAD TUBE ANGLE
STEUERROHRWINKEL
- STA** SEAT TUBE ANGLE
SITZROHRWINKEL
- BB** BOTTOM BRACKET DROP
INNENLAGERABSENKUNG
- WB** WHEELBASE
RADSTAND
- ST** STACK
STACK
- RE** REACH
REACH
- SOH** STANDOVER HEIGHT
ÜBERSTANDSHÖHE
- HEAD SET DIAMETER (UPPER / LOWER)
STEUERSATZDURCHMESSER (OBEN / UNTEN)

- AXLE STANDARD (REAR / FRONT)
ACHSENSTANDARD (HINTEN / VORNE)
- BOTTOM BRACKET STANDARD
TRETLAGERSTANDARD
- SEAT POST DIAMETER
SITZELSTÜTZENDURCHMESSER
- SHOCK HARDWARE (Ø 8 MM)
DÄMPFERBUCHSENMAÛE (Ø 8 MM)
- SHOCK LENGTH
DÄMPFERENBAULÄNGE
- SHOCK TRAVEL
DÄMPFERHUB
- FRONT FORK TRAVEL
FEDERWEG VORNE
- REAR WHEEL TRAVEL
FEDERWEG HINTEN
- STEM LENGTH
VORBAULÄNGE
- HANDLEBAR WIDTH
LENKERBREITE
- CRANK LENGTH
KURBELLÄNGE
- SEAT TUBE BOTTLE MOUNT
FLASCHE SITZELROHR
- DOWNTUBE BOTTLE MOUNT
FLASCHE UNTERROHR

	STL	CSL	TTL	HTL	HTA	STA	BB	WB	ST	RE	SOH																		
KATO FS PRO																													
XS	385	430	550	110	66	77	21.6	1145	587	415	698	44 / 56	148/110	BSA 73	31,6	30x8 / 30x8	210	50	130	130	50	800	170	0	750				
S	395	430	586	110	66	77	21.6	1181	587	451	700	44 / 56	148/110	BSA 73	31,6	30x8 / 30x8	210	50	130	130	50	800	170	0	750				
M	415	450	606	120	66	77	36.2	1231	625	463	715	44 / 56	148/110	BSA 73	31,6	30x8 / 30x8	210	50	130	130	50	800	170	0	750				
L	435	450	641	135	66	77	36.2	1268	639	494	726	44 / 56	148/110	BSA 73	31,6	30x8 / 30x8	210	50	130	130	50	800	175	0	750				
XL	465	450	674	160	66	77	36.2	1305	662	521	744	44 / 56	148/110	BSA 73	31,6	30x8 / 30x8	210	50	130	130	50	800	175	0	750				
KATO FS UNIVERSAL																													
XS	385	430	550	100	66	77	22	1145	578	419	698	44 / 56	148/110	BSA 73	31,6	30 / 30	210	50	130	130	50	700	170	-	0,75				
S	395	430	586	110	66	77	22	1181	587	451	700	44 / 56	148/110	BSA 73	31,6	30 / 30	210	50	130	130	50	720	170	-	0,75				
M	415	450	606	120	66	77	36	1231	625	463	715	44 / 56	148/110	BSA 73	31,6	30 / 30	210	50	130	130	50	740	175	0,4	0,75				
L	435	450	641	135	66	77	36	1268	639	494	726	44 / 56	148/110	BSA 73	31,6	30 / 30	210	50	130	130	50	740	175	0,4	0,75				
XL	465	450	674	160	66	77	36	1305	662	521	744	44 / 56	148/110	BSA 73	31,6	30 / 30	210	50	130	130	50	780	175	0,4	0,75				
KATO FS ESSENTIAL																													
XS	385	430	550	110	66	77	21.6	1145	587	415	698	44 / 56	148/110	BSA 73	31,6	30x8 / 30x8	210	50	130	130	50	740	170	0	750				
S	395	430	586	110	66	77	21.6	1181	587	451	700	44 / 56	148/110	BSA 73	31,6	30x8 / 30x8	210	50	130	130	50	740	170	0	750				
M	415	450	606	120	66	77	36.2	1231	625	463	715	44 / 56	148/110	BSA 73	31,6	30x8 / 30x8	210	50	130	130	50	780	175	0	750				
L	435	450	641	135	66	77	36.2	1268	639	494	726	44 / 56	148/110	BSA 73	31,6	30x8 / 30x8	210	50	130	130	50	780	175	0	750				
XL	465	450	674	160	66	77	36.2	1305	662	521	744	44 / 56	148/110	BSA 73	31,6	30x8 / 30x8	210	50	130	130	50	780	175	0	750				
KATO FS																													
XS	385	430	550	110	66	77	21.6	1145	587	415	698	44 / 56	148/110	BSA 73	31,6	30x8 / 30x8	210	50	130	130	50	740	170	0	750				
S	395	430	586	110	66	77	21.6	1181	587	451	700	44 / 56	148/110	BSA 73	31,6	30x8 / 30x8	210	50	130	130	50	740	170	0	750				
M	415	450	606	120	66	77	36.2	1231	625	463	715	44 / 56	148/110	BSA 73	31,6	30x8 / 30x8	210	50	130	130	50	780	175	0	750				
L	435	450	641	135	66	77	36.2	1268	639	494	726	44 / 56	148/110	BSA 73	31,6	30x8 / 30x8	210	50	130	130	50	780	175	0	750				
XL	465	450	674	160	66	77	36.2	1305	662	521	744	44 / 56	148/110	BSA 73	31,6	30x8 / 30x8	210	50	130	130	50	780	175	0	750				

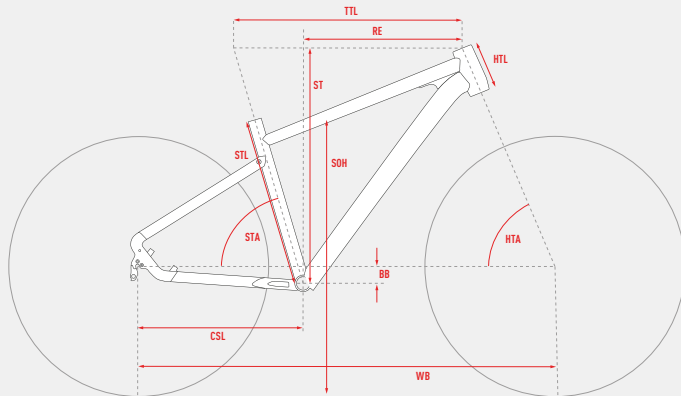

KATO

















ALL DIMENSIONS IN MM (EXCEPT HTA AND STA IN °)

ALLE MAßE IN MM (AUSNAHME HTA UND STA IN °)

- STL** SEAT TUBE LENGTH
SITZROHRLÄNGE
- CSL** CHAINSTAY LENGTH
KETTENSTREBELÄNGE
- TTL** TOP TUBE LENGTH
OBERROHRLÄNGE
- HTL** HEAD TUBE LENGTH
STEUERROHRLÄNGE
- HTA** HEAD TUBE ANGLE
STEUERROHRWINKEL
- STA** SEAT TUBE ANGLE
SITZROHRWINKEL
- BB** BOTTOM BRACKET DROP
INNENLAGERABSENKUNG
- WB** WHEELBASE
RADSTAND
- ST** STACK
STACKE
- RE** REACH
REICHWEITE
- SOH** STANDOVER HEIGHT
ÜBERSTANDSHÖHE
-  HEAD SET DIAMETER (UPPER / LOWER)
STEUERSATZDURCHMESSER (OBEN / UNTEN)

-  AXLE STANDARD (REAR / FRONT)
ACHSENSTANDARD (HINTEN / VORNE)
-  BOTTOM BRACKET STANDARD
TRETLAGERSTANDARD
-  SEAT POST DIAMETER
SÄTTELSTÜTZENDURCHMESSER
-  SHOCK HARDWARE (Ø 8 MM)
DÄMPFERBUCHSENMAßE (Ø 8 MM)
-  SHOCK LENGTH
DÄMPFERENBAULÄNGE
-  SHOCK TRAVEL
DÄMPFERHUB
-  FRONT FORK TRAVEL
FEDERWEG VORNE
-  REAR WHEEL TRAVEL
FEDERWEG HINTEN
-  STEM LENGTH
VORBAULÄNGE
-  HANDLEBAR WIDTH
LENKERBREITE
-  CRANK LENGTH
KURBELLENGE
-  SEAT TUBE BOTTLE MOUNT
FLASCHE SÄTTELROHR
-  DOWNTUBE BOTTLE MOUNT
FLASCHE UNTERROHR

	STL	CSL	TTL	HTL	HTA	STA	BB	WB	ST	RE	SOH																
KATO PRO 29"																											
S	400	450	575	105	68	73.5	60	1112	613	392	715	44 / 44	135/100	BSA 73	30,9	- / -	0	0	100	0	50	720	170	-	0,75		
M	440	450	595	115	68	73.5	60	1133	622	409	735	44 / 44	135/100	BSA 73	30,9	- / -	0	0	100	0	50	740	170	0,5	0,75		
L	480	450	615	125	68	73.5	60	1154	632	426	765	44 / 44	135/100	BSA 73	30,9	- / -	0	0	100	0	50	740	175	0,75	0,75		
XL	520	450	635	135	68	73.5	60	1175	641	443	780	44 / 44	135/100	BSA 73	30,9	- / -	0	0	100	0	50	760	175	0,75	0,75		
KATO ADVANCED 29"																											
S	400	450	575	105	68	73.5	60	1112	613	392	715	44 / 44	135/100	BSA 73	30,9	- / -	0	0	100	0	50	720	170	-	0,75		
M	440	450	595	115	68	73.5	60	1133	622	409	735	44 / 44	135/100	BSA 73	30,9	- / -	0	0	100	0	50	740	170	0,5	0,75		
L	480	450	615	125	68	73.5	60	1154	632	426	765	44 / 44	135/100	BSA 73	30,9	- / -	0	0	100	0	50	740	175	0,75	0,75		
XL	520	450	635	135	68	73.5	60	1175	641	443	780	44 / 44	135/100	BSA 73	30,9	- / -	0	0	100	0	50	760	175	0,75	0,75		
KATO UNIVERSAL 29"																											
S	400	450	575	105	68	73.5	60	1112	613	392	715	44 / 44	135/100	BSA 73	30,9	- / -	0	0	100	0	50	720	170	-	0,75		
M	440	450	595	115	68	73.5	60	1133	622	409	735	44 / 44	135/100	BSA 73	30,9	- / -	0	0	100	0	50	740	170	0,5	0,75		
L	480	450	615	125	68	73.5	60	1154	632	426	765	44 / 44	135/100	BSA 73	30,9	- / -	0	0	100	0	50	740	175	0,75	0,75		
XL	520	450	635	135	68	73.5	60	1175	641	443	780	44 / 44	135/100	BSA 73	30,9	- / -	0	0	100	0	50	760	175	0,75	0,75		
KATO ESSENTIAL 29"																											
S	400	450	575	105	68	73.5	60	1112	613	392	715	44 / 44	135/100	BSA 73	30,9	- / -	0	0	100	0	50	720	170	-	0,75		
M	440	450	595	115	68	73.5	60	1133	622	409	735	44 / 44	135/100	BSA 73	30,9	- / -	0	0	100	0	50	740	170	0,5	0,75		
L	480	450	615	125	68	73.5	60	1154	632	426	765	44 / 44	135/100	BSA 73	30,9	- / -	0	0	100	0	50	740	175	0,75	0,75		
XL	520	450	635	135	68	73.5	60	1175	641	443	780	44 / 44	135/100	BSA 73	30,9	- / -	0	0	100	0	50	760	175	0,75	0,75		
KATO 29"																											
S	400	450	575	105	68	73.5	60	1112	613	392	715	44 / 44	135/100	BSA 73	30,9	- / -	0	0	100	0	50	720	170	-	0,75		
M	440	450	595	115	68	73.5	60	1133	622	409	735	44 / 44	135/100	BSA 73	30,9	- / -	0	0	100	0	50	740	170	0,5	0,75		
L	480	450	615	125	68	73.5	60	1154	632	426	765	44 / 44	135/100	BSA 73	30,9	- / -	0	0	100	0	50	740	175	0,75	0,75		
XL	520	450	635	135	68	73.5	60	1175	641	443	780	44 / 44	135/100	BSA 73	30,9	- / -	0	0	100	0	50	760	175	0,75	0,75		
KATO EQ 29"																											
S	400	450	575	105	68	73.5	60	1112	613	392	715	44 / 44	135/100	BSA 73	30,9	- / -	0	0	100	0	50	720	170	-	0,75		
M	440	450	595	115	68	73.5	60	1133	622	409	735	44 / 44	135/100	BSA 73	30,9	- / -	0	0	100	0	50	740	170	0,5	0,75		
L	480	450	615	125	68	73.5	60	1154	632	426	765	44 / 44	135/100	BSA 73	30,9	- / -	0	0	100	0	50	740	175	0,75	0,75		
XL	520	450	635	135	68	73.5	60	1175	641	443	780	44 / 44	135/100	BSA 73	30,9	- / -	0	0	100	0	50	760	175	0,75	0,75		



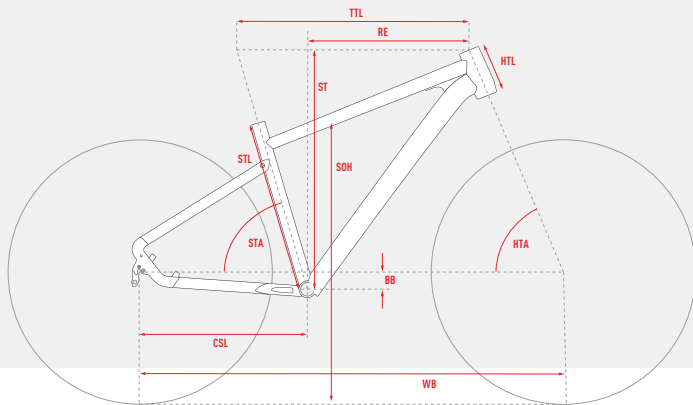









KATO

















ALL DIMENSIONS IN MM (EXCEPT HTA AND STA IN °)

ALLE MAßE IN MM (AUSNAHME HTA UND STA IN °)

- STL** SEAT TUBE LENGTH
SITZROHRLÄNGE
- CSL** CHAINSTAY LENGTH
KETTENSTREBENLÄNGE
- TTL** TOP TUBE LENGTH
OBERROHRLÄNGE
- HTL** HEAD TUBE LENGTH
STEUERROHRLÄNGE
- HTA** HEAD TUBE ANGLE
STEUERROHRWINKEL
- STA** SEAT TUBE ANGLE
SITZROHRWINKEL
- BB** BOTTOM BRACKET DROP
INNENLAGERABSENKUNG
- WB** WHEELBASE
RADSTAND
- ST** STACK
STACK
- RE** REACH
REACH
- SOH** STANDOVER HEIGHT
ÜBERSTANDSHÖHE
-  HEAD SET DIAMETER (UPPER / LOWER)
STEUERSATZDURCHMESSER (OBEN / UNTEN)

-  AXLE STANDARD (REAR / FRONT)
ACHSENSTANDARD (HINTEN / VORNE)
-  BOTTOM BRACKET STANDARD
TRETLAGERSTANDARD
-  SEAT POST DIAMETER
SITTELSTÜTZENDURCHMESSER
-  SHOCK HARDWARE (Ø 8 MM)
DÄMPFERBUCHSENMAßE (Ø 8 MM)
-  SHOCK LENGTH
DÄMPFERENBAULÄNGE
-  SHOCK TRAVEL
DÄMPFERHUB
-  FRONT FORK TRAVEL
FEDERWEG VORNE
-  REAR WHEEL TRAVEL
FEDERWEG HINTEN
-  STEM LENGTH
VORBAULÄNGE
-  HANDLEBAR WIDTH
LENKERBREITE
-  CRANK LENGTH
KURBELLENGE
-  SEAT TUBE BOTTLE MOUNT
FLASCHE SITTELROHR
-  DOWNTUBE BOTTLE MOUNT
FLASCHE UNTERROHR

	STL	CSL	TTL	HTL	HTA	STA	BB	WB	ST	RE	SOH																
KATO PRO 27.5"																											
XS	360	430	545	105	68	73.5	45	1063	588	371	680	44 / 44	135/100	BSA 73	31.6	- / -	0	0	100	0	50	700	170	-	0.5		
S	400	430	570	115	68	73.5	45	1089	598	393	710	44 / 44	135/100	BSA 73	31.6	- / -	0	0	100	0	50	720	170	-	0.75		
M	440	430	590	125	68	73.5	45	1110	607	411	730	44 / 44	135/100	BSA 73	31.6	- / -	0	0	100	0	50	740	170	0.5	0.75		
KATO ADVANCED 27.5"																											
XS	360	430	545	105	68	73.5	45	1063	588	371	680	44 / 44	135/100	BSA 73	31.6	- / -	0	0	100	0	50	700	170	-	0.5		
S	400	430	570	115	68	73.5	45	1089	598	393	710	44 / 44	135/100	BSA 73	31.6	- / -	0	0	100	0	50	720	170	-	0.75		
M	440	430	590	125	68	73.5	45	1110	607	411	730	44 / 44	135/100	BSA 73	31.6	- / -	0	0	100	0	50	740	170	0.5	0.75		
KATO UNIVERSAL 27.5"																											
XS	360	430	545	105	68	73.5	45	1063	588	371	680	44 / 44	135/100	BSA 73	31.6	- / -	0	0	100	0	50	700	170	-	0.5		
S	400	430	570	115	68	73.5	45	1089	598	393	710	44 / 44	135/100	BSA 73	31.6	- / -	0	0	100	0	50	720	170	-	0.75		
M	440	430	590	125	68	73.5	45	1110	607	411	730	44 / 44	135/100	BSA 73	31.6	- / -	0	0	100	0	50	740	170	0.5	0.75		
KATO ESSENTIAL 27.5"																											
XS	360	430	545	105	68	73.5	45	1063	588	371	680	44 / 44	135/100	BSA 73	31.6	- / -	0	0	100	0	50	700	170	-	0.5		
S	400	430	570	115	68	73.5	45	1089	598	393	710	44 / 44	135/100	BSA 73	31.6	- / -	0	0	100	0	50	720	170	-	0.75		
M	440	430	590	125	68	73.5	45	1110	607	411	730	44 / 44	135/100	BSA 73	31.6	- / -	0	0	100	0	50	740	170	0.5	0.75		
KATO 27.5"																											
XS	360	430	545	105	68	73.5	45	1063	588	371	680	44 / 44	135/100	BSA 73	31.6	- / -	0	0	100	0	50	700	175	-	0.5		
S	400	430	570	115	68	73.5	45	1089	598	393	710	44 / 44	135/100	BSA 73	31.6	- / -	0	0	100	0	50	720	170	-	0.75		
M	440	430	590	125	68	73.5	45	1110	607	411	730	44 / 44	135/100	BSA 73	31.6	- / -	0	0	100	0	50	740	170	0.5	0.75		
KATO EQ 27.5"																											
XS	360	430	545	105	68	73.5	45	1063	588	371	680	44 / 44	135/100	BSA 73	31.6	- / -	0	0	100	0	50	700	170	-	0.5		
S	400	430	570	115	68	73.5	45	1089	598	393	710	44 / 44	135/100	BSA 73	31.6	- / -	0	0	100	0	50	720	170	-	0.75		
M	440	430	590	125	68	73.5	45	1110	607	411	730	44 / 44	135/100	BSA 73	31.6	- / -	0	0	100	0	50	740	170	0.5	0.75		



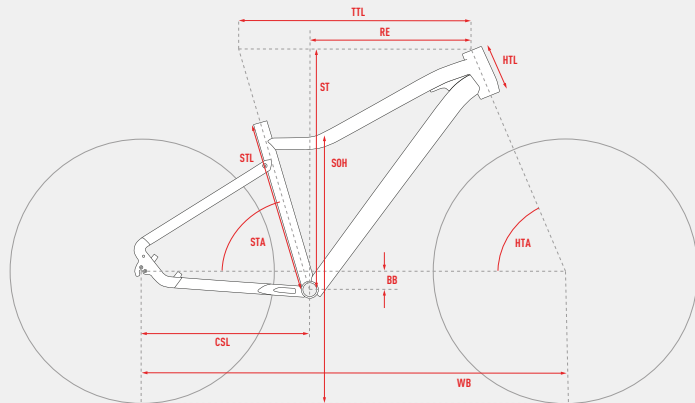











LANAO































ALL DIMENSIONS IN MM (EXCEPT HTA AND STA IN °)















ALLE MAßE IN MM (AUSNAHME HTA UND STA IN °)















- STL** SEAT TUBE LENGTH
SITZROHRLÄNGE
- CSL** CHAINSTAY LENGTH
KETTENSTREBENLÄNGE
- TTL** TOP TUBE LENGTH
OBERROHRLÄNGE
- HTL** HEAD TUBE LENGTH
STEUERROHRLÄNGE
- HTA** HEAD TUBE ANGLE
STEUERROHRWINKEL
- STA** SEAT TUBE ANGLE
SITZROHRWINKEL
- BB** BOTTOM BRACKET DROP
INNENLAGERABSENKUNG
- WB** WHEELBASE
RADSTAND
- ST** STACK
STACK
- RE** REACH
REACH
- SOH** STANDOVER HEIGHT
ÜBERSTANDSHÖHE
-  HEAD SET DIAMETER (UPPER / LOWER)
STEUERSATZDURCHMESSER (OBEN / UNTEN)
-  AXLE STANDARD (REAR / FRONT)
ACHSENSTANDARD (HINTEN / VORNE)
-  BOTTOM BRACKET STANDARD
TRETLAGERSTANDARD
-  SEAT POST DIAMETER
SITTELSTÜTZENDURCHMESSER
-  SHOCK HARDWARE (Ø 8 MM)
DÄMPFERBUCHSENMAßE (Ø 8 MM)
-  SHOCK LENGTH
DÄMPFERENBAULÄNGE
-  SHOCK TRAVEL
DÄMPFERHUB
-  FRONT FORK TRAVEL
FEDERWEG VORNE
-  REAR WHEEL TRAVEL
FEDERWEG HINTEN
-  STEM LENGTH
VORBAULÄNGE
-  HANDLEBAR WIDTH
LENKERBREITE
-  CRANK LENGTH
KURBELLENLÄNGE
-  SEAT TUBE BOTTLE MOUNT
FLASCHE SITTELROHR
-  DOWNTUBE BOTTLE MOUNT
FLASCHE UNTERROHR















	STLv	CSL	TTL	HTL	HTA	STA	BB	WB	ST	RE	SOH																
LANAO PRO 27.5"																											
XS	360	430	545	105	68	73.5	45	1063	588	371	680	44 / 44	135/100	BSA 73	31.6	- / -	0	0	100	0	50	700	170	-	0.5		
S	400	430	570	115	68	73.5	45	1089	598	393	710	44 / 44	135/100	BSA 73	31.6	- / -	0	0	100	0	50	720	170	-	0.75		
M	440	430	590	125	68	73.5	45	1110	607	411	730	44 / 44	135/100	BSA 73	31.6	- / -	0	0	100	0	50	740	170	0.5	0.75		

	STL	CSL	TTL	HTL	HTA	STA	BB	WB	ST	RE	SOH																
LANAO ADVANCED 27.5"																											
XS	360	430	545	105	68	73.5	45	1063	588	371	680	44 / 44	135/100	BSA 73	31.6	- / -	0	0	100	0	50	700	170	-	0.5		
S	400	430	570	115	68	73.5	45	1089	598	393	710	44 / 44	135/100	BSA 73	31.6	- / -	0	0	100	0	50	720	170	-	0.75		
M	440	430	590	125	68	73.5	45	1110	607	411	730	44 / 44	135/100	BSA 73	31.6	- / -	0	0	100	0	50	740	170	0.5	0.75		

	STL	CSL	TTL	HTL	HTA	STA	BB	WB	ST	RE	SOH																
LANAO UNIVERSAL 27.5"																											
XS	360	430	545	105	68	73.5	45	1063	588	371	680	44 / 44	135/100	BSA 73	31.6	- / -	0	0	100	0	50	700	170	-	0.5		
S	400	430	570	115	68	73.5	45	1089	598	393	710	44 / 44	135/100	BSA 73	31.6	- / -	0	0	100	0	50	720	170	-	0.75		
M	440	430	590	125	68	73.5	45	1110	607	411	730	44 / 44	135/100	BSA 73	31.6	- / -	0	0	100	0	50	740	170	0.5	0.75		

	STL	CSL	TTL	HTL	HTA	STA	BB	WB	ST	RE	SOH																
LANAO ESSENTIAL 27.5"																											
XS	360	430	545	105	68	73.5	45	1063	588	371	680	44 / 44	135/100	BSA 73	31.6	- / -	0	0	100	0	50	700	170	-	0.5		
S	400	430	570	115	68	73.5	45	1089	598	393	710	44 / 44	135/100	BSA 73	31.6	- / -	0	0	100	0	50	720	170	-	0.75		
M	440	430	590	125	68	73.5	45	1110	607	411	730	44 / 44	135/100	BSA 73	31.6	- / -	0	0	100	0	50	740	170	0.5	0.75		

	STL	CSL	TTL	HTL	HTA	STA	BB	WB	ST	RE	SOH																
LANAO 27.5"																											
XS	360	430	545	105	68	73.5	45	1063	588	371	680	44 / 44	135/100	BSA 73	31.6	- / -	0	0	100	0	50	700	170	-	0.5		
S	400	430	570	115	68	73.5	45	1089	598	393	710	44 / 44	135/100	BSA 73	31.6	- / -	0	0	100	0	50	720	170	-	0.75		
M	440	430	590	125	68	73.5	45	1110	607	411	730	44 / 44	135/100	BSA 73	31.6	- / -	0	0	100	0	50	740	170	0.5	0.75		

	STL	CSL	TTL	HTL	HTA	STA	BB	WB	ST	RE	SOH																
LANAO EQ 27.5"																											
XS	360	430	545	105	68	73.5	45	1063	588	371	680	44 / 44	135/100	BSA 73	31.6	- / -	0	0	100	0	50	700	170	-	0.5		
S	400	430	570	115	68	73.5	45	1089	598	393	710	44 / 44	135/100	BSA 73	31.6	- / -	0	0	100	0	50	720	170	-	0.75		
M	440	430	590	125	68	73.5	45	1110	607	411	730	44 / 44	135/100	BSA 73	31.6	- / -	0	0	100	0	50	740	170	0.5	0.75		

RIOT YOUTH

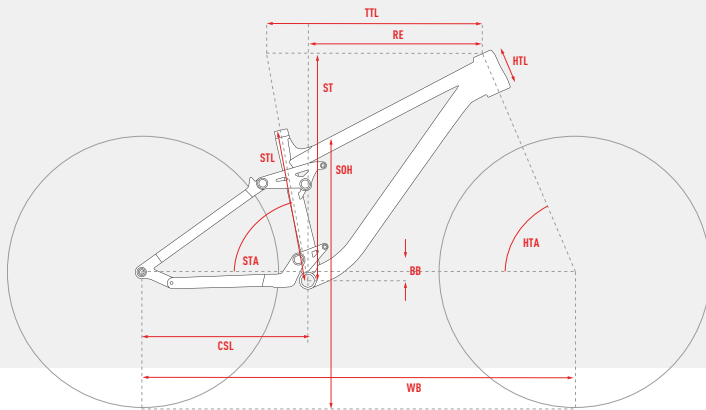

- STL** SEAT TUBE LENGTH
SITZROHRLÄNGE
- CSL** CHAINSTAY LENGTH
KETTENSTREBENLÄNGE
- TTL** TOP TUBE LENGTH
OBERROHRLÄNGE
- HTL** HEADTUBE LENGTH
STEUERROHRLÄNGE
- HTA** HEADTUBE ANGLE
STEUERROHRWINKEL
- RE** REACH
REACH
- SOH** STANDOVER HEIGHT
ÜBERSTANDSHÖHE
- HEAD SET DIAMETER (UPPER / LOWER)
STEUERSATZDURCHMESSER (OBEN / UNTEN)
- AXLE STANDARD (REAR / FRONT)
ACHSENSTANDARD (HINTEN / VORNE)
- BOTTOM BRACKET STANDARD
TRETLAGERSTANDARD
- SEAT POST DIAMETER
SITTELSTÜTZENDURCHMESSER

- SHOCK HARDWARE (Ø 8 MM)
DÄMPFERBUCHSENMAßE (Ø 8 MM)
- SHOCK LENGTH
DÄMPFEREINBAULÄNGE
- SHOCK TRAVEL
DÄMPFERHUB
- FRONT FORK TRAVEL
FEDERWEG VORNE
- REAR WHEEL TRAVEL
FEDERWEG HINTEN
- STEM LENGTH
VORBAULÄNGE
- HANDLEBAR WIDTH
LENKERBREITE
- CRANK LENGTH
KURBELLÄNGE
- SEAT TUBE BOTTLE MOUNT
FLASCHE SITTELROHR
- DOWNTUBE BOTTLE MOUNT
FLASCHE UNTERROHR

ALL DIMENSIONS IN MM (EXCEPT HTA AND STA IN °)

ALLE MAßE IN MM (AUSNAHME HTA UND STA IN °)

	STL	CSL	TTL	HTL	HTA	STA	BB	WB	ST	RE	SOH															
RIOT YOUTH PRO																										
XS	385	430	550	100	66	77	22	1145	578	419	698	44 / 56	148/110	BSA 73	31.6	30 / 30	210	50	130	130	50	700	170	-	0.5	

KATO YOUTH

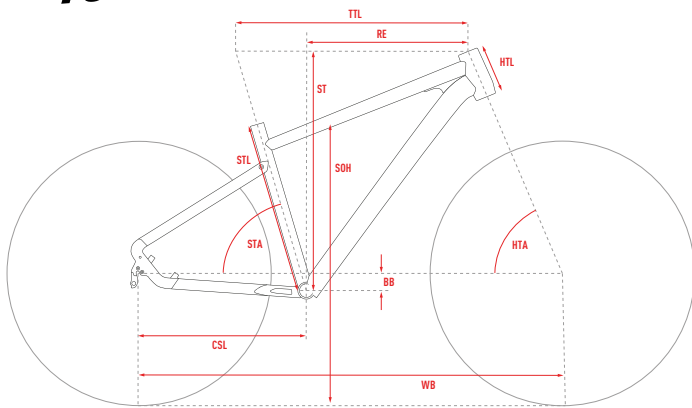

- STL** SEAT TUBE LENGTH
SITZROHRLÄNGE
- CSL** CHAINSTAY LENGTH
KETTENSTREBENLÄNGE
- TTL** TOP TUBE LENGTH
OBERROHRLÄNGE
- HTL** HEAD TUBE LENGTH
STEUERROHRLÄNGE
- HTA** HEAD TUBE ANGLE
STEUERROHRWINKEL
- STA** SEAT TUBE ANGLE
SITZROHRWINKEL
- BB** BOTTOM BRACKET DROP
INNENLAGERABSENKUNG
- WB** WHEELBASE
RADSTAND
- ST** STACK
RADSTAND
- RE** REACH
REACH
- SOH** STANDOVER HEIGHT
ÜBERSTANDSHÖHE
- HEAD SET DIAMETER (UPPER / LOWER)
STEUERSATZDURCHMESSER (OBEN / UNTEN)

- AXLE STANDARD (REAR / FRONT)
ACHSENSTANDARD (HINTEN / VORNE)
- BOTTOM BRACKET STANDARD
TRETLAGERSTANDARD
- SEAT POST DIAMETER
SITTELSTÜTZENDURCHMESSER
- SHOCK HARDWARE (Ø 8 MM)
DÄMPFERBUCHSENMAßE (Ø 8 MM)
- SHOCK LENGTH
DÄMPFEREINBAULÄNGE
- SHOCK TRAVEL
DÄMPFERHUB
- FRONT FORK TRAVEL
FEDERWEG VORNE
- REAR WHEEL TRAVEL
FEDERWEG HINTEN
- STEM LENGTH
VORBAULÄNGE
- HANDLEBAR WIDTH
LENKERBREITE
- CRANK LENGTH
KURBELLÄNGE
- SEAT TUBE BOTTLE MOUNT
FLASCHE SITTELROHR
- DOWNTUBE BOTTLE MOUNT
FLASCHE UNTERROHR

ALL DIMENSIONS IN MM (EXCEPT HTA AND STA IN °)

ALLE MAßE IN MM (AUSNAHME HTA UND STA IN °)

	STL	CSL	TTL	HTL	HTA	STA	BB	WB	ST	RE	SOH															
KATO YOUTH																										
XXS	340	430	531	95	68	73.5	45	1048	579	360	670	44 / 44	135/100	BSA 73	31.6	- / -	0	0	100	0	50	700	170	-	0.5	

	STL	CSL	TTL	HTL	HTA	STA	BB	WB	ST	RE	SOH															
KATO YOUTH EQ																										
XXS	340	430	531	95	68	73.5	45	1048	579	360	670	44 / 44	135/100	BSA 73	31.6	- / -	0	0	100	0	50	700	170	-	0.5	

LANAO YOUTH

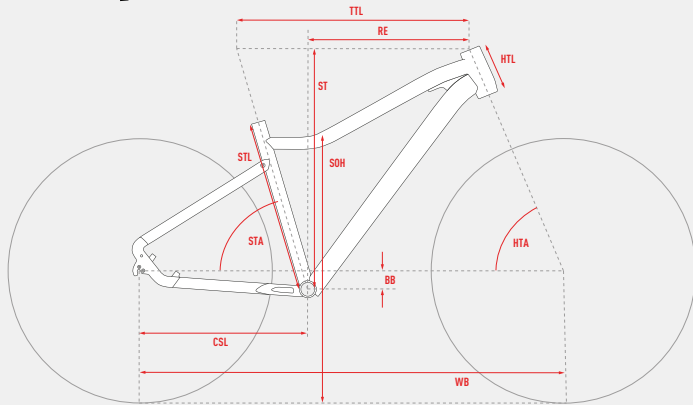















ALL DIMENSIONS IN MM (EXCEPT HTA AND STA IN °)

ALLE MAßE IN MM (AUSNAHME HTA UND STA IN °)















- STL** SEAT TUBE LENGTH
SITZROHRLÄNGE
- CSL** CHAINSTAY LENGTH
KETTENSTREBENLÄNGE
- TTL** TOP TUBE LENGTH
OBERROHRLÄNGE
- HTL** HEAD TUBE LENGTH
STEUERROHRLÄNGE
- HTA** HEAD TUBE ANGLE
STEUERROHRWINKEL
- STA** SEAT TUBE ANGLE
SITZROHRWINKEL
- BB** BOTTOM BRACKET DROP
INNENLAGERABSENKUNG
- WB** WHEELBASE
RADSTAND
- ST** STACK
STACK
- RE** REACH
REACH
- SOH** STANDOVER HEIGHT
ÜBERSTANDSHÖHE
-  **HEAD SET DIAMETER (UPPER / LOWER)**
STEUERSATZDURCHMESSER (OBEN / UNTEN)

-  **AXLE STANDARD (REAR / FRONT)**
ACHSENSTANDARD (HINTEN / VORNE)
-  **BOTTOM BRACKET STANDARD**
TRETLAGERSTANDARD
-  **SEAT POST DIAMETER**
SATTELSTÜTZENDURCHMESSER
-  **SHOCK HARDWARE (Ø 8 MM)**
DAMPFERBUCHSENMAßE (Ø 8 MM)
-  **SHOCK LENGTH**
DAMPFEREINBAULÄNGE
-  **SHOCK TRAVEL**
DAMPFERHUB
-  **FRONT FORK TRAVEL**
FEDERWEG VORNE
-  **REAR WHEEL TRAVEL**
FEDERWEG HINTEN
-  **STEM LENGTH**
VORBAULÄNGE
-  **HANDLEBAR WIDTH**
LENKERBREITE
-  **CRANK LENGTH**
KURBELLÄNGE
-  **SEAT TUBE BOTTLE MOUNT**
FLASCHE SATTELROHR
-  **DOWN TUBE BOTTLE MOUNT**
FLASCHE UNTERROHR

STL CSL TTL HTL HTA STA BB WB ST RE SOH              

LANAO YOUTH

XXS 340 430 531 95 68 73.5 45 1048 579 360 670 44 / 44 135/100 BSA 73 31,6 - / - 0 0 100 0 50 700 170 - 0,5

STL CSL TTL HTL HTA STA BB WB ST RE SOH              

LANAO YOUTH EQ

XXS 340 430 531 95 68 73.5 45 1048 579 360 670 44 / 44 135/100 BSA 73 31,6 - / - 0 0 100 0 50 700 170 - 0,5

KATO KID

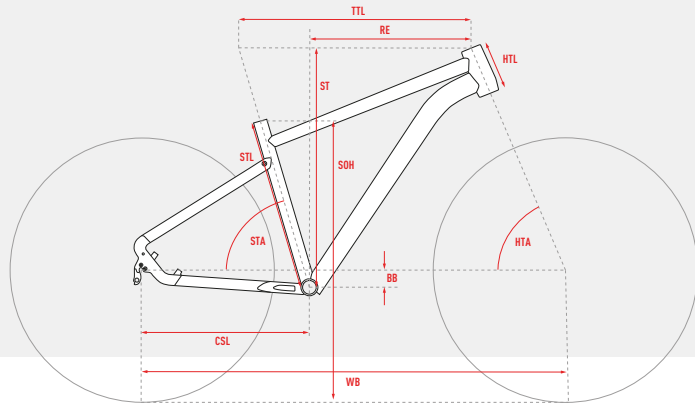

ALL DIMENSIONS IN MM (EXCEPT HTA AND STA IN °)

ALLE MAßE IN MM (AUSNAHME HTA UND STA IN °)

- STL** SEAT TUBE LENGTH
SITZROHRLÄNGE
- CSL** CHAINSTAY LENGTH
KETTENSTREBENLÄNGE
- TTL** TOP TUBE LENGTH
OBERROHRLÄNGE
- HTL** HEAD TUBE LENGTH
STEUERROHRLÄNGE
- HTA** HEAD TUBE ANGLE
STEUERROHRWINKEL
- STA** SEAT TUBE ANGLE
SITZROHRWINKEL
- BB** BOTTOM BRACKET DROP
INNENLAGERABSENKUNG
- WB** WHEELBASE
RADSTAND
- ST** STACK
REACH
- RE** REACH
REACH
- SOH** STANDOVER HEIGHT
ÜBERSTANDSHÖHE
- HEAD SET DIAMETER (UPPER / LOWER)**
STEUERSATZDURCHMESSER (OBEN / UNTEN)

- AXLE STANDARD (REAR / FRONT)**
ACHSENSTANDARD (HINTEN / VORNE)
- BOTTOM BRACKET STANDARD**
TRETLAGERSTANDARD
- SEAT POST DIAMETER**
SATTELSTÜTZENDURCHMESSER
- SHOCK HARDWARE (Ø 8 MM)**
DÄMPFERBUCHSENMAßE (Ø 8 MM)
- SHOCK LENGTH**
DÄMPFEREINBAULÄNGE
- SHOCK TRAVEL**
DÄMPFERHUB
- FRONT FORK TRAVEL**
FEDERWEG VORNE
- REAR WHEEL TRAVEL**
FEDERWEG HINTEN
- STEM LENGTH**
VORBAULÄNGE
- HANDLEBAR WIDTH**
LENKERBREITE
- CRANK LENGTH**
KURBELLÄNGE
- SEAT TUBE BOTTLE MOUNT**
FLASCHE SATTELROHR
- DOWNTUBE BOTTLE MOUNT**
FLASCHE UNTERROHR

	STL	CSL	TTL	HTL	HTA	STA	BB	WB	ST	RE	SOH														
KATO 24 FULL PARTY																									
24	300	410	506	110	69	69	40	971	512	338	543	44 / 44	135/100	BSA 73	27.2	- / -	0	0	80	0	40	560	140	-	-
KATO 24 PRO																									
24	300	410	506	110	69	69	40	971	512	338	543	44 / 44	135/100	BSA 73	27.2	- / -	0	0	50	0	40	560	140	-	-
KATO 24 PRO EQ																									
24	300	410	506	110	69	69	40	971	512	338	543	44 / 44	135/100	BSA 73	27.2	- / -	0	0	0	0	40	560	140	-	-
KATO 20 FULL PARTY																									
20	250	362	437	110	68	69	45	843	455	280	473	44 / 44	135/100	BSA 73	27.2	- / -	0	0	50	0	40	540	114	-	-
KATO 20 PRO																									
20	250	362	437	110	68	69	45	843	455	280	473	44 / 44	135/100	BSA 73	27.2	- / -	0	0	0	0	40	540	114	-	-

LANAO KID

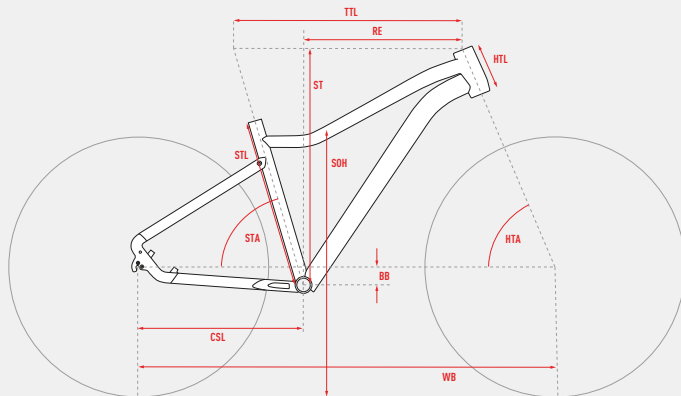

ALL DIMENSIONS IN MM (EXCEPT HTA AND STA IN °)

ALLE MAßE IN MM (AUSNAHME HTA UND STA IN °)

- STL** SEAT TUBE LENGTH
SITZROHRLÄNGE
- CSL** CHAINSTAY LENGTH
KETTENSTREBENLÄNGE
- TTL** TOP TUBE LENGTH
OBERROHRLÄNGE
- HTL** HEAD TUBE LENGTH
STEUERROHRLÄNGE
- HTA** HEAD TUBE ANGLE
STEUERROHRWINKEL
- STA** SEAT TUBE ANGLE
SITZROHRWINKEL
- BB** BOTTOM BRACKET DROP
INNENLAGERABSENKUNG
- WB** WHEELBASE
RADSTAND
- ST** STACK
REACH
- RE** REACH
REACH
- SOH** STANDOVER HEIGHT
ÜBERSTANDSHÖHE
- HEAD SET DIAMETER (UPPER / LOWER)
STEUERSATZDURCHMESSER (OBEN / UNTEN)
- AXLE STANDARD (REAR / FRONT)
ACHSENSTANDARD (HINTEN / VORNE)
- BOTTOM BRACKET STANDARD
TRETLAGERSTANDARD
- SEAT POST DIAMETER
SATTELSTÜTZENDURCHMESSER
- SHOCK HARDWARE (Ø 8 MM)
DÄMPFERBUCHSENMAßE (Ø 8 MM)
- SHOCK LENGTH
DÄMPFEREINBAULÄNGE
- SHOCK TRAVEL
DÄMPFERHUB
- FRONT FORK TRAVEL
FEDERWEG VORNE
- REAR WHEEL TRAVEL
FEDERWEG HINTEN
- STEM LENGTH
VORBAULÄNGE
- HANDLEBAR WIDTH
LENKERBREITE
- CRANK LENGTH
KURBELLÄNGE
- SEAT TUBE BOTTLE MOUNT
FLASCHE SATTELROHR
- DOWNTUBE BOTTLE MOUNT
FLASCHE UNTERROHR

	STL	CSL	TTL	HTL	HTA	STA	BB	WB	ST	RE	SOH														
LANAO 24 FULL PARTY																									
24	300	410	506	110	69	69	40	971	512	338	543	44 / 44	135/100	BSA 73	27.2	- / -	0	0	80	0	40	560	140	-	-
LANAO 24 PRO																									
24	300	410	506	110	69	69	40	971	512	338	543	44 / 44	135/100	BSA 73	27.2	- / -	0	0	50	0	40	560	140	-	-
LANAO 24 PRO EQ																									
24	300	410	506	110	69	69	40	971	512	338	543	44 / 44	135/100	BSA 73	27.2	- / -	0	0	0	0	40	560	140	-	-
LANAO 20 FULL PARTY																									
20	250	362	437	110	68	69	45	843	455	280	473	44 / 44	135/100	BSA 73	27.2	- / -	0	0	50	0	40	540	114	-	-
LANAO 20 PRO																									
20	250	362	437	110	68	69	45	843	455	280	473	44 / 44	135/100	BSA 73	27.2	- / -	0	0	0	0	40	540	114	-	-



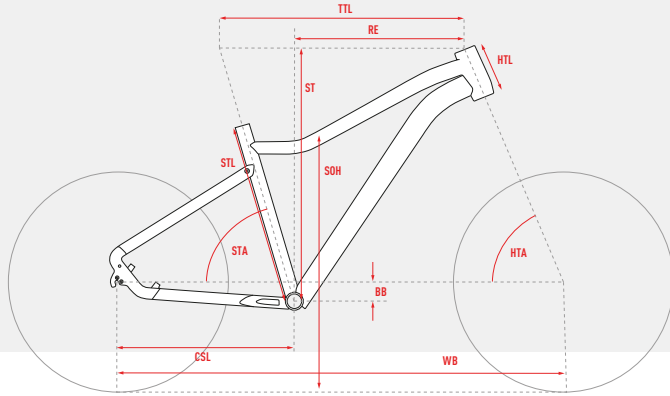







POWERKID













ALL DIMENSIONS IN MM (EXCEPT HTA AND STA IN °)

ALLE MAßE IN MM (AUSNAHME HTA UND STA IN °)

- STL** SEAT TUBE LENGTH
SITZROHRLÄNGE
- CSL** CHAINSTAY LENGTH
KETTENSTREBENLÄNGE
- TTL** TOP TUBE LENGTH
OBERROHRLÄNGE
- HTL** HEAD TUBE LENGTH
STEUERROHRLÄNGE
- HTA** HEAD TUBE ANGLE
STEUERROHRWINKEL
- STA** SEAT TUBE ANGLE
SITZROHRWINKEL
- BB** BOTTOM BRACKET DROP
INNENLAGERABSENKUNG
- WB** WHEELBASE
RADSTAND
- ST** STACK
STACK
- RE** REACH
REACH
- SOH** STANDOVER HEIGHT
ÜBERSTANDSHÖHE
-  HEAD SET DIAMETER (UPPER / LOWER)
STEUERSATZDURCHMESSER (OBEN / UNTEN)

-  AXLE STANDARD (REAR / FRONT)
ACHSENSTANDARD (HINTEN / VORNE)
-  BOTTOM BRACKET STANDARD
TRETLAGERSTANDARD
-  SEAT POST DIAMETER
SITZELSTÜTZENDURCHMESSER
-  SHOCK HARDWARE (Ø 8 MM)
DÄMPFERBUCHSENMAßE (Ø 8 MM)
-  SHOCK LENGTH
DÄMPFEREINBAULÄNGE
-  SHOCK TRAVEL
DÄMPFERHUB
-  FRONT FORK TRAVEL
FEDERWEG VORNE
-  REAR WHEEL TRAVEL
FEDERWEG HINTEN
-  STEM LENGTH
VORBAULÄNGE
-  HANDLEBAR WIDTH
LENKERBREITE
-  CRANK LENGTH
KURBELLÄNGE
-  SEAT TUBE BOTTLE MOUNT
FLASCHE SÄTTELROHR
-  DOWNTUBE BOTTLE MOUNT
FLASCHE UNTERROHR

	STL	CSL	TTL	HTL	HTA	STA	BB	WB	ST	RE	SOH																
POWERKID 16																											
16	230	315	367	100	71	73	3	737	356	273	391	30 / 30	110/100	BSA 68	27.2	- / -	0	0	0	0	40	460	114	-	-		
POWERKID 12																											
12	180	262	302	100	71	73	10	612	292	225	335	30 / 30	110/100	BSA 68	27.2	- / -	0	0	0	0	40	460	89	-	-		

POWERKIDDY

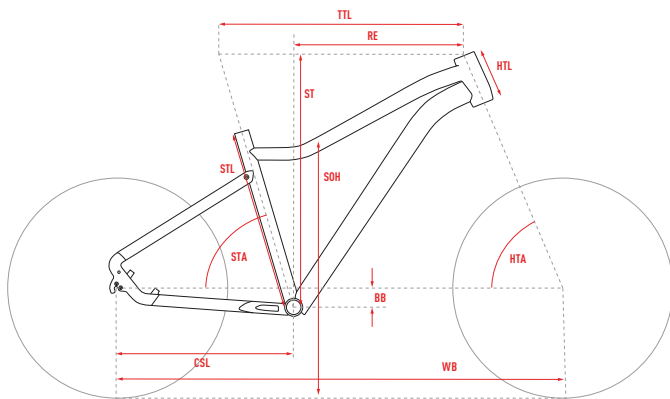

ALL DIMENSIONS IN MM (EXCEPT HTA AND STA IN °)

ALLE MAßE IN MM (AUSNAHME HTA UND STA IN °)

- STL** SEAT TUBE LENGTH
SITZROHRLÄNGE
- CSL** CHAINSTAY LENGTH
KETTENSTREBENLÄNGE
- TTL** TOP TUBE LENGTH
OBERROHRLÄNGE
- HTL** HEAD TUBE LENGTH
STEUERROHRLÄNGE
- HTA** HEAD TUBE ANGLE
STEUERROHRWINKEL
- STA** SEAT TUBE ANGLE
SITZROHRWINKEL
- BB** BOTTOM BRACKET DROP
INNENLAGERABSENKUNG
- WB** WHEELBASE
RADSTAND
- ST** STACK
STACK
- RE** REACH
REACH
- SOH** STANDOVER HEIGHT
ÜBERSTANDSHÖHE
-  HEAD SET DIAMETER (UPPER / LOWER)
STEUERSATZDURCHMESSER (OBEN / UNTEN)

-  AXLE STANDARD (REAR / FRONT)
ACHSENSTANDARD (HINTEN / VORNE)
-  BOTTOM BRACKET STANDARD
TRETLAGERSTANDARD
-  SEAT POST DIAMETER
SITZELSTÜTZENDURCHMESSER
-  SHOCK HARDWARE (Ø 8 MM)
DÄMPFERBUCHSENMAßE (Ø 8 MM)
-  SHOCK LENGTH
DÄMPFEREINBAULÄNGE
-  SHOCK TRAVEL
DÄMPFERHUB
-  FRONT FORK TRAVEL
FEDERWEG VORNE
-  REAR WHEEL TRAVEL
FEDERWEG HINTEN
-  STEM LENGTH
VORBAULÄNGE
-  HANDLEBAR WIDTH
LENKERBREITE
-  CRANK LENGTH
KURBELLÄNGE
-  SEAT TUBE BOTTLE MOUNT
FLASCHE SÄTTELROHR
-  DOWNTUBE BOTTLE MOUNT
FLASCHE UNTERROHR

	STL	CSL	TTL	HTL	HTA	STA	BB	WB	ST	RE	SOH																
POWERKIDDY 12																											
12	190	240	293	70	70	75.9	0	595	257	236	310	30 / 30	100/100	BSA 68	27.2	- / -	0	0	0	0	40	460	-	-	-		

SQUARE ^{CROSS}

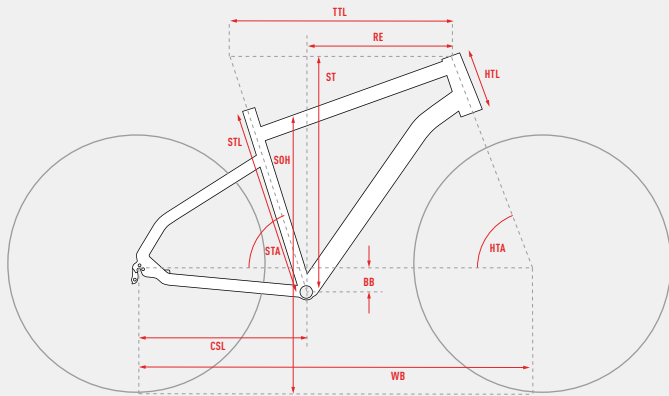





























ALL DIMENSIONS IN MM (EXCEPT HTA AND STA IN °)















ALLE MADE IN MM (AUSNAHME HTA UND STA IN °)















- STL** SEAT TUBE LENGTH
SITZROHRLÄNGE
- CSL** CHAINSTAY LENGTH
KETTENSTREBELÄNGE
- TTL** TOP TUBE LENGTH
OBERROHRLÄNGE
- HTL** HEAD TUBE LENGTH
STEUERROHRLÄNGE
- HTA** HEAD TUBE ANGLE
STEUERROHRWINKEL
- STA** SEAT TUBE ANGLE
SITZROHRWINKEL
- BB** BOTTOM BRACKET DROP
INNENLAGERABSENKUNG
- WB** WHEELBASE
RADSTAND
- ST** STACK
STACK
- RE** REACH
REACH
- SOH** STANDOVER HEIGHT
ÜBERSTANDSHÖHE
-  HEAD SET DIAMETER (UPPER / LOWER)
STEUERSATZDURCHMESSER (OBEN / UNTEN)

-  AXLE STANDARD (REAR / FRONT)
ACHSENSTANDARD (HINTEN / VORNE)
-  BOTTOM BRACKET STANDARD
TRETLAGERSTANDARD
-  SEAT POST DIAMETER
SITTELSTÜTZENDURCHMESSER
-  SHOCK HARDWARE (Ø 8 MM)
DÄMPFERBUCHSENMAßE (Ø 8 MM)
-  SHOCK LENGTH
DÄMPFERENBAULÄNGE
-  SHOCK TRAVEL
DÄMPFERHUB
-  FRONT FORK TRAVEL
FEDERWEG VORNE
-  REAR WHEEL TRAVEL
FEDERWEG HINTEN
-  STEM LENGTH
VORBAULÄNGE
-  HANDLEBAR WIDTH
LENKERBREITE
-  CRANK LENGTH
KURBELLENGE
-  SEAT TUBE BOTTLE MOUNT
FLASCHE SITTELROHR
-  DOWNTUBE BOTTLE MOUNT
FLASCHE UNTERROHR

	STL	CSL	TTL	HTL	HTA	STA	BB	WB	ST	RE	SOH																
SQUARE CROSS ESSENTIAL																											
S	470	455	580	160	70	73.5	60	1105	636	391	735	44 / 56	135/100	BSA 68	31.6	- / -	0	0	65	0	75	680	175	0.75	0.75		
M	520	455	595	165	70	72.5	60	1108	641	393	770	44 / 56	135/100	BSA 68	31.6	- / -	0	0	65	0	75	680	175	0.75	0.75		
L	570	455	610	185	71	72.5	60	1112	664	400	815	44 / 56	135/100	BSA 68	31.6	- / -	0	0	65	0	75	680	175	0.75	0.75		
XL	620	455	625	205	71	72	60	1121	683	403	855	44 / 56	135/100	BSA 68	31.6	- / -	0	0	65	0	75	680	175	0.75	0.75		

	STL	CSL	TTL	HTL	HTA	STA	BB	WB	ST	RE	SOH																
SQUARE CROSS ESSENTIAL W																											
XS	420	455	560	150	70.5	73	60	1073	629	368	630	44 / 56	135/100	BSA 68	31.6	- / -	0	0	65	0	75	680	175	-	0.75		
S	470	455	575	155	70.5	72	60	1076	634	369	625	44 / 56	135/100	BSA 68	31.6	- / -	0	0	65	0	75	680	175	-	0.75		
M	520	455	590	170	70.5	72	60	1091	648	379	625	44 / 56	135/100	BSA 68	31.6	- / -	0	0	65	0	75	680	175	-	0.75		
L	560	455	610	185	70.5	72	60	1112	662	395	625	44 / 56	135/100	BSA 68	31.6	- / -	0	0	65	0	75	680	175	-	0.75		

	STL	CSL	TTL	HTL	HTA	STA	BB	WB	ST	RE	SOH																
SQUARE CROSS BASE																											
S	470	455	580	160	70	73.5	60	1105	636	391	735	44 / 56	135/100	BSA 68	31.6	- / -	0	0	63	0	75	680	175	0.75	0.75		
M	520	455	595	165	70	72.5	60	1108	641	393	770	44 / 56	135/100	BSA 68	31.6	- / -	0	0	63	0	75	680	175	0.75	0.75		
L	570	455	610	185	71	72.5	60	1112	664	400	815	44 / 56	135/100	BSA 68	31.6	- / -	0	0	63	0	75	680	175	0.75	0.75		
XL	620	455	625	205	71	72	60	1121	683	403	855	44 / 56	135/100	BSA 68	31.6	- / -	0	0	63	0	75	680	175	0.75	0.75		

	STL	CSL	TTL	HTL	HTA	STA	BB	WB	ST	RE	SOH																
SQUARE CROSS BASE W																											
XS	420	455	560	150	70.5	73	60	1073	629	368	630	44 / 56	135/100	BSA 68	31.6	- / -	0	0	63	0	75	680	175	-	0.75		
S	470	455	575	155	70.5	72	60	1076	634	369	625	44 / 56	135/100	BSA 68	31.6	- / -	0	0	63	0	75	680	175	-	0.75		
M	520	455	590	170	70.5	72	60	1091	648	379	625	44 / 56	135/100	BSA 68	31.6	- / -	0	0	63	0	75	680	175	-	0.75		
L	560	455	610	185	70.5	72	60	1112	662	395	625	44 / 56	135/100	BSA 68	31.6	- / -	0	0	63	0	75	680	175	-	0.75		

SQUARE TREKKING

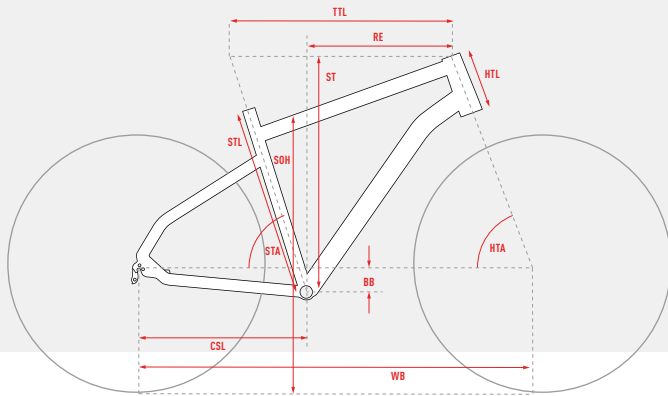

ALL DIMENSIONS IN MM (EXCEPT HTA AND STA IN °)

ALLE MAßE IN MM (AUSNAHME HTA UND STA IN °)

- STL** SEAT TUBE LENGTH
SITZROHRLÄNGE
- CSL** CHAINSTAY LENGTH
KETTENSTREBENLÄNGE
- TTL** TOP TUBE LENGTH
OBERROHRLÄNGE
- HTL** HEAD TUBE LENGTH
STEUERROHRLÄNGE
- HTA** HEAD TUBE ANGLE
STEUERROHRWINKEL
- STA** SEAT TUBE ANGLE
SITZROHRWINKEL
- BB** BOTTOM BRACKET DROP
INNENLAGERABSENKUNG
- WB** WHEELBASE
RADSTAND
- ST** STACK
STACK
- RE** REACH
REACH
- SOH** STANDOVER HEIGHT
ÜBERSTANDSHÖHE
- SOH** HEAD SET DIAMETER (UPPER / LOWER)
STEUERSATZDURCHMESSER (OBEN / UNTEN)
- AS** AXLE STANDARD (REAR / FRONT)
ACHSENSTANDARD (HINTEN / VORNE)
- BS** BOTTOM BRACKET STANDARD
TRETLAGERSTANDARD
- SD** SEAT POST DIAMETER
SÄTTELSTÜTZENDURCHMESSER
- SH** SHOCK HARDWARE (Ø 8 MM)
DÄMPFERBUCHSENMAßE (Ø 8 MM)
- SL** SHOCK LENGTH
DÄMPFEREINBAULÄNGE
- ST** SHOCK TRAVEL
DÄMPFERHUB
- FF** FRONT FORK TRAVEL
FEDERWEG VORNE
- FR** REAR WHEEL TRAVEL
FEDERWEG HINTEN
- SL** STEM LENGTH
VORBAULÄNGE
- HW** HANDLEBAR WIDTH
LENKERBREITE
- CL** CRANK LENGTH
KURBELLÄNGE
- ST** SEAT TUBE BOTTLE MOUNT
FLASCHE SÄTTELROHR
- DT** DOWNTUBE BOTTLE MOUNT
FLASCHE UNTERROHR

	STL	CSL	TTL	HTL	HTA	STA	BB	WB	ST	RE	SOH														
SQUARE TREKKING ESSENTIAL																									
S	470	455	580	160	70	73.5	60	1105	636	391	735	44 / 56	135/100	BSA 68	31.6	- / -	0	0	63	0	75	680	175	0.75	0.75
M	520	455	595	165	70	72.5	60	1108	641	393	770	44 / 56	135/100	BSA 68	31.6	- / -	0	0	63	0	75	680	175	0.75	0.75
L	570	455	610	185	71	72.5	60	1112	664	400	815	44 / 56	135/100	BSA 68	31.6	- / -	0	0	63	0	75	680	175	0.75	0.75
XL	620	455	625	205	71	72	60	1121	683	403	855	44 / 56	135/100	BSA 68	31.6	- / -	0	0	63	0	75	680	175	0.75	0.75

	STL	CSL	TTL	HTL	HTA	STA	BB	WB	ST	RE	SOH														
SQUARE TREKKING ESSENTIAL W																									
XS	420	455	560	150	70.5	73	60	1073	629	368	630	44 / 56	135/100	BSA 68	31.6	- / -	0	0	63	0	75	680	175	-	0.75
S	470	455	575	155	70.5	72	60	1076	634	369	625	44 / 56	135/100	BSA 68	31.6	- / -	0	0	63	0	75	680	175	-	0.75
M	520	455	590	170	70.5	72	60	1091	648	379	625	44 / 56	135/100	BSA 68	31.6	- / -	0	0	63	0	75	680	175	-	0.75
L	560	455	610	185	70.5	72	60	1112	662	395	625	44 / 56	135/100	BSA 68	31.6	- / -	0	0	63	0	75	680	175	-	0.75

	STL	CSL	TTL	HTL	HTA	STA	BB	WB	ST	RE	SOH														
SQUARE TREKKING BASE																									
S	470	455	580	160	70	73.5	60	1105	636	391	735	44 / 56	135/100	BSA 68	31.6	- / -	0	0	63	0	75	680	175	0.75	0.75
M	520	455	595	165	70	72.5	60	1108	641	393	770	44 / 56	135/100	BSA 68	31.6	- / -	0	0	63	0	75	680	175	0.75	0.75
L	570	455	610	185	71	72.5	60	1112	664	400	815	44 / 56	135/100	BSA 68	31.6	- / -	0	0	63	0	75	680	175	0.75	0.75
XL	620	455	625	205	71	72	60	1121	683	403	855	44 / 56	135/100	BSA 68	31.6	- / -	0	0	63	0	75	680	175	0.75	0.75

	STL	CSL	TTL	HTL	HTA	STA	BB	WB	ST	RE	SOH														
SQUARE TREKKING BASE W																									
XS	420	455	560	150	70.5	73	60	1073	629	368	630	44 / 56	135/100	BSA 68	31.6	- / -	0	0	63	0	75	680	175	-	0.75
S	470	455	575	155	70.5	72	60	1076	634	369	625	44 / 56	135/100	BSA 68	31.6	- / -	0	0	63	0	75	680	175	-	0.75
M	520	455	590	170	70.5	72	60	1091	648	379	625	44 / 56	135/100	BSA 68	31.6	- / -	0	0	63	0	75	680	175	-	0.75
L	560	455	610	185	70.5	72	60	1112	662	395	625	44 / 56	135/100	BSA 68	31.6	- / -	0	0	63	0	75	680	175	-	0.75

TECHNIK LEXIKON // TECHNOLOGY GLOSSARY

170
160

FEDERWEG // TRAVEL

ERSTE ZAHL = FEDERWEG VORNE
ZWEITE ZAHL = FEDERWEG HINTEN
FIRST NUMBER = FRONT TRAVEL
SECOND NUMBER = REAR TRAVEL

UC

RAHMENMATERIAL // FRAME MATERIAL

ULTRALIGHT CARBON // Federleicht über den Trail fliegen? Die besten Voraussetzungen für beste Performance bietet unser Ultralight Carbon.
ULTRALIGHT CARBON // Light as a feather - flying over the trail? Our Ultralight Carbon offers the best foundation for best performance.

LC

RAHMENMATERIAL // FRAME MATERIAL

LIGHT CARBON // Vereint ein hohes Maß an Steifigkeit bei geringem Gewicht mit Komfort.
Das Ergebnis: stabilere, formschöne Rohre und direkte Kraftübertragung.
LIGHT CARBON // Combines a high degree of stiffness with comfort at low weight. The result: sturdier, beautifully designed tubes and direct power transmission.

AL

RAHMENMATERIAL // FRAME MATERIAL

ALUMINIUM // Der Klassiker unter den Rahmenmaterialien steht für Langlebigkeit sowie ein sehr gutes Verhältnis von Steifigkeit zu Gewicht.
ALUMINIUM // The classic frame material stands for durability as well as a very good stiffness-to-weight ratio.

+210
READY

VORBEREITET FÜR RANGE EXTENDER // RANGE EXTENDER READY

LUST AUF MEHR? // Mit dem Zusatzakku kannst du dir optional extra Power gönnen. Dieser ergänzt die Leistung des Hauptakkus oder ersetzt diesen sogar.
WANT MORE? // With the Range Extender you get additional power. This battery will supplement the main battery or even replace it.

BALL BEARINGS

VOLLKUGELIGE INDUSTRIELAGER // FULL COMPLEMENT BEARING

DETAILS, DIE SICH LOHNEN // Höchster Standard für alle. Mit den langlebigen, gedichteten Kugellagern sind unsere Mountainbikes bestens gegen alle äußeren Einflüsse geschützt.
DETAILS THAT ARE WORTHWHILE // The highest standard for all! With the long-life, sealed ball bearings our mountain bikes are well protected against dirt, shear forces or wear.

COMPLETE LOCKOUT

COMPLETE LOCKOUT // VOLLSTÄNDIGER LOCKOUT

Mehr Kontrolle oder mehr Federweg // Die Lockout Funktion der Gabel und des Dämpfers kannst du in Sekunden vom Lenker aus steuern. So kannst du das Maximum aus deinem Bike herausholen.
MORE CONTROL OR MORE TRAVEL? // You can control the lockout function of the fork and the damper remotely from the handlebar in mere seconds. That's how you get the maximum out of your bike.

TIRE LESS

SCHLAUCHLOS // TUBELESS

NIE WIEDER LÖCHER IN SCHLAUCH // Schlauchlos-Bereifung bietet eindeutige Vorteile bei Schnelligkeit, Komfort, Grip und Pannensicherheit. Zusätzlich verbauen wir Tire Noodles um die Felge zu schützen. Für den Notfall liefern wir zudem ein Reparaturkit für den Mantel mit.
NO MORE HOLES IN TUBES // Tubeless tires offer clear advantages in speed, comfort, grip and puncture resistance. Additionally a built in tire noodle offers extra protection for the rim. For emergencies we also include a tire repair kit.

PEPS PTN

PEPS PTN

DURCHSCHLAGSCHUTZ // Bietet Tubeless-Reifen ein Höchstmaß an Reifenflankenstabilität, besten Schutz gegen Burping und guten Felgenschutz mit sehr geringem Rollwiderstand.
PUNCTURE AND RIM DAMAGE PROTECTION // Provides tubeless tires with maximum tire sidewall stability, best protection against burping and good rim protection with very low rolling resistance.

FORGED DROPOUT

GESCHMIEDETE AUSFALLENDEN // FORGED DROPOUT

WIE ANGELOSSEN // Unsere geschmiedeten Ausfallenden sind hochwertig verarbeitet, erzielen besonders hohe Steifigkeitswerte und integrieren sich zudem perfekt in unser Rahmendesign.
THE PERFECT FIT // Our forged dropouts are manufactured to a high quality, obtaining particularly high stiffness values, and are perfectly integrated into our frame design.

FORGED YOK

GESCHMIEDETE KETTENSTREBENBRÜCKE // FORGED CHAINSTAY YOKE

GESCHMIEDETE LÖSUNG // Die Verbindung von Kettenstrebe und Tretlager ist eine ganz entscheidende Stelle am Bike. Durch unsere aufwendige Schmiede-Lösung erreichen wir eine sehr hohe Steifig- und Festigkeit.
FORGED SOLUTION // The connection between the chainstay and bottom bracket is a very crucial point on the bike. With our elaborate forged solution we achieve a very high degree of stiffness and strength.

GHOST FORK

GHOST-GABELSYSTEM // GHOST FORK SYSTEM

ALUMINIUM ODER CARBON - SELBST ENTWICKELT // Unsere eigenen Gabeln sind das Tüpfelchen auf dem i. Speziell für cleane und superschnelle Bikes haben wir optimierte Lösungen geschaffen.
ALUMINIUM OR CARBON - SELF-DEVELOPED // Our own forks are the icing on the cake. We created optimum solutions particularly for clean and fast bikes.

VARIO FORK

ABSENBARE FEDERGABEL // VARIO FORK

ZWEI GABELN IN EINER // Tiefe Front für den Anstieg und voller Federweg für die Abfahrt. Die Federgabeln mit zwei unterschiedlichen Federwegslängen verändern den Charakter des Bikes maßgeblich.
ONE SUSPENSION FORK, TWO OPTIONS // Low front for the climb, and the entire travel for the downhill. The suspension forks with two different positions considerably change the bike's personality.

INNER ROUTING

INNEN VERLEGTE ZÜGE // INNER ROUTING

SAUBERE SACHE MIT SUPER SCHUTZ // Innen verlegte Züge und Leitungen sind besser gegen äußere Einflüsse geschützt und sorgen für eine cleane Optik am Bike.
KEEPING IT CLEAN WITH SUPER PROTECTION // Better protection and a cleaner look: The main advantages of internal cables and routing.

INVISIBLE ROUTING

UNSIHTBARE KABELFÜHRUNG // INVISIBLE CABLE ROUTING

SAUBER VERLEGT, LEICHT ZUGÄNLICH // Unsichtbar verlegt, aber trotzdem offen zugänglich: Mit der speziellen Form des Unterrohrs lassen wir die Züge verschwinden. Sollte mal etwas sein, kommt man aber immer noch ohne großen Aufwand dran.
INVISIBLY ROUTED, YET EASILY ACCESSIBLE // Invisibly routed, yet still easily accessible: The cables disappear invisibly in the unique shape of our downtube. If needed, easy access is guaranteed.

ISCG 05

ISCG 05 // ISCG 05

INTERNATIONALER STANDARD FÜR INTEGRIERTEN SCHUTZ // Der International Standard Chain Guide ist eine genormte 3-Punkt-Befestigung von Kettenführungen direkt am Tretlagergehäuse. Bei der Montage von Kettenführungen muss das Tretlager nicht mehr ein- oder ausgebaut werden.
INTERNATIONAL STANDARD FOR INTEGRATED PROTECTION // The International Standard Chain Guide is a standardized 3-point mount chain guide installed directly on the bottom bracket shell. When mounting chain guides the bottom bracket no longer needs to be installed or removed.

THROUGH AXLE

STECKACHSEN-STANDARD // THROUGH-AXLE STANDARD

MEHR KONTROLLE AUF DEN TRAILS // Ein Standard, der bei abfahrtslastigen Bikes ein Muss ist. Die Steckachse ermöglicht ein noch steiferes Dreieck im Hinterbau und führt zu einer besseren Kräfteverteilung und -verteilung.
MORE CONTROL ON THE TRAILS // A standard that is a „must“ in downhill-focused bikes. The thru-axle allows for an even stiffer rear triangle and guarantees improved force transmission and distribution.

PROTECTION

RAHMENSCHUTZ // FRAME PROTECTION

SCHÜTZ DEIN RAD // Bei fast allen Fullys und den Carbon-Hardtails Standard: unser Rahmenschutz. Denn geschützt fährt's sich am besten!
PROTECT YOUR BIKE // Standard on almost all full-suspensions and carbon hardtails - our frame protection. Protection guarantees the best rides!

BOOST

BOOST STANDARD // BOOST STANDARD

BREITER IST BESSER // Boost bedeutet breitere Naben. So einfach das ist, so groß ist die Verbesserung: Breitere Naben bringen mehr Stabilität.
WIDER IS BETTER // Boost means wider hubs. A small adjustment for a great improvement: Wider hubs bring more stability.

RACE READY

RACE READY // RACE READY

WETTKAMPFORIENTIERT // Wir wissen, was es auf der Strecke braucht. Zum einen, weil unsere Teamfahrer uns ständig mit viel Feedback versorgen. Zum anderen besteht unser Entwicklungsteam selbst aus ehemaligen (und teils noch aktiven) Rennfahrern. So liefern wir ein rennfertiges Produkt, das aus dem Karton bereit für die Strecke ist.
A COMPETITIVE SPIRIT // We know what is needed on the track. First, because our team riders constantly provide us with a lot of feedback. Second, our development team itself is made up of former (and still partly active) racers. That's how we deliver a race-ready product: ready for the track right out of the box.

FEM

FEM-BERECHNET // FEM CALCULATED

KOMPLEXE BERECHNUNGEN FÜR UNKOMPLIZIERTE LÖSUNGEN // Unsere FEM-optimierten Rahmen wurden mit aufwendigen Kalkulationen bis ins letzte Detail verbessert. Dadurch ergeben sich simple Lösungen, die aber viel komplexer sind, als man vermutet.
COMPLEX CALCULATIONS FOR UNCOMPLICATED SOLUTIONS // Our optimized FEM frames have been improved with complex calculations down to the last detail. The resulting, seemingly simple solutions are much more complex than they appear.

BOTTLESPACE READY

VORBEREITET FÜR TRINKFLASCHENHALTER // BOTTLESPACE READY

ERFRISCHENDER STAUHAUM VORPROGRAMMIERT // Hier gibt's genügend Platz für eine Erfrischung unterwegs. Bei Bikes mit diesem Symbol, bekommt du locker eine Trinkflasche im Rahmendreieck unterwegs.
DESIGNED WITH TRULY REFRESHING STORAGE IN MIND // There's plenty of space for refreshments. Bikes featuring this symbol provide enough space for a bottle.

VARIO-READY

VORBEREITUNG FÜR INNEN VERLEGTE TELESKOPSTÜTZE // READY FOR DROPPER SEATPOST

ABSENKEN FÜR MEHR FREIHEIT // Unsere Rahmen sind bereit für absehbare Sattelstützen: Die Zugführung lässt sich sauber und gut geschützt innen verlegen.
LOWER FOR MORE FREEDOM // Our frames are already prepared for dropper seat posts: The cables can be routed inside the tubes for a clean look and better protection.

BOSCH SMART SYSTEM

BOSCH SMART SYSTEM // BOSCH SMART SYSTEM

DIE NÄCHSTE STUFE // Mit dem neuen smarten System hebt Bosch das E-Bike auf das nächste Level. Die vollvernetzte Kombination aus Akku, Display, Drive Unit und eBike Flow App sorgt für ein neues E-Bike Erlebnis.
THE NEXT LEVEL // With the new smart system, Bosch is taking e-bikes to the next level. The fully networked combination of battery, display, drive unit and eBike Flow app ensures a new e-bike experience.

BOSCH MOTOR

BOSCH MOTOR // BOSCH MOTOR

BEWAHRTER ANTRIEB MIT ORDNENTLICH VORTRIEB // Diese bereits bekannten Elektroantriebe garantieren hervorragende Qualität, Leistungsfähigkeit und Langlebigkeit in praktischem Design.
A PROVEN MOTOR WITH RESPECTABLE POWER // These well-known electric drives guarantee excellent quality, performance and durability in a compact design.

FULLY INTEGRATED

VOLL-INTEGRIERTER AKKU // FULLY INTEGRATED BATTERY

GUT VERSTAUT // Mit geringstem Materialaufwand optisch schick integriert: die neuen Bikes mit Vollintegration.
NEATLY HIDDEN // Artfully integrated and looking like a million bucks without spending a lot on materials: the new bikes with full-integration.

MXer CONCEPT

HYBRIDE MXER-KONZEPT // HYBRIDE MXER CONCEPT

DIE ANTWORT AUF BESTE PERFORMANCE // MXer klingt wie Motocross? Richtig. Großes, schmales 29" Vorderrad und kleines, breites 27.5" Hinterrad sorgen für beste Spurführung und Überrollverhalten sowie maximale Traktion und Kraftübertragung am Heck.
THE ANSWER FOR BEST PERFORMANCE // MXer sounds like Motocross? Correct. A big „slim 29“ front wheel and a small, wide 27.5“ rear wheel guarantee great directional stability, low rolling resistance, maximum traction and power transmission at the rear.

SHORT EMTB CRANK

KÜRZE EMTB-KURBEL // SHORT EMTB CRANK

MEHR KURBELN STATT KÄMPFEN // Nicht nur mehr Bodenfreiheit, sondern auch eine bessere Motornutzung dank kürzerer Kurbeln: Diese führen automatisch zu höherer Trittfrequenz und lassen die Motoren in einer besseren Kraftzone arbeiten.
MORE PEDALING, LESS STRUGGLING // Shorter cranks mean not only more ground clearance, but also improved motor use: They automatically result in a higher cadence and make the motor work in an improved power zone.



SCHEIBENBREMSSE // DISC BRAKE

BESTE BREMSKRAFT, BESTENS DOSIERBAR // Ob in der Stadt oder im Gelände: Die hydraulischen Scheibenbremsen greifen auch bei Nässe zuverlässig sicher und schnell.
BEST BRAKING POWER, WITH EXCEPTIONAL CTRL // Whether in town or on terrain: The hydraulic disc brakes guarantee a safe and fast grip even in wet conditions.



VERBAUTE SCHUTZBLECHE // INSTALLED FENDERS

DEIN SCHUTZ GEGEN DRECK // Für alle, die ihre Kleidung vor Schmutzspritzern schützen wollen: Diese Bikes haben die Schutzbleche bereits montiert.
YOUR PROTECTION AGAINST DIRT // For everyone who wants to protect their clothing from splashes of dirt: these bikes have already mounted the fenders.



STAHLFEDERDÄMPFER // COIL SHOCK

UNKOMPLIZIERT UND ZUVERLÄSSIG // Weniger Wartungsaufwand, höhere Zuverlässigkeit, unerreichte Performance und einfaches Set-up. Wer sich Zeit, Aufwand und Dämpfer-Pumpe sparen will, der liegt mit einem Stahlfederdämpfer absolut richtig.
UNCOMPLICATED AND RELIABLE // Less maintenance, higher reliability, unbeatable performance and easy setup. For those who want to save time, effort and shock pump, a coil shock is just up their alley.



INTEGRIERTER GEPÄCKTRÄGER // INTEGRATED CARRIER

ELEGANT UNAUFFÄLLIG UND TROTZDEM BELASTBAR // Unser Gepäckträger ist schlicht und einfach. Im elegant unauffälligen Design steckt aber eine extrem steife, robuste Konstruktion, die mit 25 Kilo belastbar und mit den gängigsten Taschensystemen von anderen Anbietern kompatibel ist.
ELEGANTLY INCONSPICUOUS, YET RESILIENT // Our luggage rack is plain and simple. However, the elegant and discrete design belies an extremely rigid, robust construction that can take loads of up to 25 kg and is compatible with the usual bag systems of other manufacturers.



GEKAPSELTE SCHALTUNG // ENCAPSULATED SHIFTING

GUT GESCHÜTZTER ANTRIEB // Das kompakte Nabenge triebe ist nicht nur unsichtbar versteckt, sondern auch abgeschirmt vor Schmutz und dadurch deutlich weniger empfindlich oder verschleißanfällig.
WELL PROTECTED DRIVE // The compact hub transmission is not only tucked away to make it invisible, but is also properly shielded against dirt and thus much less sensitive or susceptible to wear.



INTEGRIERTER SEITENTASCHENTRÄGER // INTEGRATED PANNIER BAG CARRIER

STYLISCH, STARK UND TRAGFAHIG // Das stylische Äußere unseres urbanen Gepäckträgers soll nicht täuschen: Die Konstruktion fügt sich optisch perfekt in das schlichte Gesamtbild ein, ist aber durchaus gut belastbar. Seitlich lassen sich Packtaschen anbringen.
STYLISH, STRONG AND SOUND // Don't be fooled by the stylish exterior of our urban luggage rack: The structure fits perfectly into the minimalist overall picture, yet is exceptionally sturdy. Panniers can also be fitted to the sides.



EINFACH-ANTRIEB // 1-BY-DRIVETRAIN

WENIGER TEILE, WENIGER STRESS // Vergiss den 2. Shifter, den Umwerfer und den Schaltzug dorthin: Beim Einfach-Antrieb kannst du dir das alles sparen. Weiterer Pluspunkt: Die Kette klappert nicht und fällt auch nicht mehr ab.
LESS PARTS, LESS HASSLE // Forget about the second shifter, the front derailleur and the cables there; with the 1-by drivetrain you don't need any of those things. No more chain slapping either. And your chain jumping off the gear is so yesterday.



HERAUSNEHMBARE BATTERIE // REMOVEABLE BATTERY

GUT VERSTAUT MIT FLEXIBLEN LADEOPTIONEN // Die In-Tube Batterien lassen sich einfach aus dem Rahmen entnehmen und können somit überall geladert und geladen werden. Auch größeren Touren steht nichts im Wege, denn ein zweiter Akku kann schnell eingesetzt werden.
WELL PLACED WITH FLEXIBLE CHARGING OPTIONS // In-tube batteries can be easily removed from the frame for storage or charging anywhere. Even longer tours are no problem, a second battery can be quickly inserted.



RIEMENANTRIEB // BELT DRIVE

ZUVERLÄSSIG BEI JEDER WITTERUNG // Keine Schmiere, kein Dreck, weniger Verschleiß und bestens geschützte Hosenbeine. Was will man mehr für den Weg ins Büro?
RELIABLE IN EVERY CONDITION // No grease, no dirt, less wear and well protected pant legs. What more do you need for your commute to the office?



KABELABDECKUNG // CABLE COVER

DESIGN TRIFFT FUNKTION // Kabelführungen benötigen einen festen Sitz und wollen versteckt sein. Unter der Kabelabdeckung am Unterrohr sind sie perfekt verstaut. Mit Hilfe des Snap-Lock Verschlusses am Cover lassen sich die Kabel werkzeuglos und im Handumdrehen für einen schnellen Service freilegen.
DESIGN MEETS FUNCTION // Cable guides need a firm fit and want to be hidden. They are perfectly stowed away under the cable cover on the down tube. With the help of the snap lock on the cover, the cables can be exposed without tools in no time at all for quick service.



TELESKOPSTÜTZE // DROPPER POST

MEHR PLATZ, WENN'S HEISS HERGEHT // Per Fernbedienung absenkbarer Sattelstütze: Eine großartige Erleichterung, wenn der Trail steil wird.
DROP IT WHEN THE TRAIL GETS ROUGH // Remote-controlled seatpost: a great help when the trail gets steep.



FAZUA RIDE 60 ANTRIEBSSYSTEM // FAZUA RIDE 60 ENGINE

LEISE, KOMPAKT & KRAFTVOLL // Der Antriebshersteller aus Ottobrunn bei München präsentiert ein Gesamtsystem, das mit seiner Kombination aus Kraft, intuitiver Bedienung und Leichtigkeit ein besonders agiles, natürliches und nahezu geräuschloses Fahrerlebnis schafft. Über alle Kategorien hinweg: RIDE 60 ist die ideale Unterstützung für smarte Commuter, ausdauernde Gravel-Biker und anspruchsvolle E-Mountainbiker.
QUIET, COMPACT AND POWERFUL // The drive manufacturer from Ottobrunn near Munich, presents a system that, with its combination of power, intuitive operation and lightness, creates a particularly agile, natural and almost effortless riding experience across all categories: RIDE 60 is the supreme assistance for smart commuters, adventurous gravel cyclists and demanding e-mountainbikers.



VORBEREITET FÜR BIKEPACKING // BIKEPACKING READY

MACH DEIN BIKE ZUM LASTENTIER // Für Packkünstler und Weltenbummler: An diese Aufnahmen lässt sich quasi alles befestigen.
MAKE YOUR BIKE A REAL WORKHORSE // For packing artists and globetrotters: You can attach pretty much anything to these mounts.



EINTEILIGER HINTERBAU // ONE-PIECE REAR TRIANGLE

EINFACH, SCHLICHT UND STEIF // Eine einteilige Hinterbau-Konstruktion bietet hohe Steifigkeit, da der Hinterbau aus festen Verbindungen besteht.
EASY, SIMPLE AND STIFF // A one-piece rear triangle construction made of solid connections offers high stiffness.



MTB-LENKZENTRALE // MTB COCKPIT

MOUNTAINBIKE-TECHNIK AUCH FÜR DEN GROSSSTADTOSCHUNDEL // Unsere DNA aus dem Mountainbikebereich ist auch auf den urbanen Strecken kein Nachteil: Beste Kontrolle und angenehme Ergonomie sind nie verkehrt.
MOUNTAIN BIKE TRICKERY FOR THE URBAN JUNGLE // Our DNA from the mountain bike sector certainly is no disadvantage on urban trails either: optimum control and comfortable ergonomics always feel good.



EINTEILIGES HEBEL // ONE-PIECE LINK

EINTEILIGES DESIGN FÜR MAXIMALE STEIFIGKEIT // Der einteilige Umlenkhebel bietet mehr Gegenhalt für Querbelastungen. Somit werden Belastungen an den Lagerstellen und am gesamten Hinterbau minimiert.
ONE-PIECE DESIGN FOR MAXIMUM STIFFNESS // The one-piece bell crank provides more counter support for lateral stress. This minimizes stress on the bearings and the entire rear triangle.



NABENDYNAMO // HUB DYNAMO

ZUVERLÄSSIG, WARTUNGSARM UND VOLLER ENERGIE // Die Nabendynamos liefern leise und leichtgängig viel Energie für zuverlässige Beleuchtung. Neben dem hohen Wirkungsgrad sind sie auch noch robust und wartungsarm.
RELIABLE, LOW MAINTENANCE AND FULL OF ENERGY // The hub dynamos quietly and smoothly deliver a lot of energy for reliable lighting. Not only are they highly efficient, they are also robust and require low maintenance.



TRACTIONLINK // TRACTIONLINK

PERFEKT ABGESTIMMTE FAHRWERK // TractionLink sorgt dafür, dass dein Bike nie an Bodenhaftung verliert, egal wie unwegsam das Gelände wird. Die Kinematik zeichnet sich durch ein besonders ausgewogenes Verhältnis zwischen Antriebsneutralität und Hinterbauperformance aus. Der Federweg wird optimal genutzt, Schläge werden souverän absorbiert und Bremsstosen gehört der Vergangenheit an.
ALWAYS PUSH ON THE TRAIL // TractionLink ensures that your bike never loses traction, no matter how rough and wild the terrain becomes. The kinematics of our new R101 is characterized by an especially well-balanced relation between pedaling efficiency and rear triangle performance. The travel is optimally used, impacts are confidently absorbed and brake stuttering is a thing of the past.



INTEGRIERTE BELEUCHTUNG // INTEGRATED LIGHTING

UNAUFFÄLLIG LEUCHTENDES BEISPIEL // Minimalistisches Design, maximale Funktion: Die Kabel unserer hochwertigen Lampen verschwinden sauber und gut geschützt im Schutzblech.
AN UNOBTRUSIVE SHINING EXAMPLE // Minimalist design, maximum functionality: The cables of our high-quality lamps disappear completely and are well protected in the mudguard.



SRAM UDH SCHALTAUGE // SRAM UDH DERAILLEUR HANGER

WIR LIEBEN STANDARD // Ein Schaltauge für alle. Um es für alle einfacher zu machen, benötigt es mehr Standards. Von SRAM kommt jetzt das „Universal derailleur hanger“ zum Einsatz, das nicht nur die Zahl an Ersatzteilen reduziert, sondern das Schaltwerk auch vor Schmutz schützt, indem es bei Schlägen nach hinten wegwippt.
WE LOVE STANDARD // One derailleur hanger for all. To make it easier for everyone, we need more standards. SRAM now uses the „Universal derailleur hanger“, which not only reduces the number of spare parts, but also protects your rear derailleur from damage by folding backwards at impact.



USB-LADEBUCHSE // USB CHARGER

UNTERWEGS AUFLADEN // Wir integrieren den Energielieferanten ins Rad: An der Lenkzentrale kann man seine Geräte unterwegs über die USB-Schnittstelle aufladen. Gespeist wird sie durch den Nabendynamo, wobei das Kabel sauber durch die Gabel verläuft.
CHARGING ON THE GO // We integrate the energy source into the bike: On the handlebars you can charge your devices on the go via the USB interface. It is powered via the hub dynamo, with the cable running cleanly through the fork.



SMARTUBE WERKZEUGE // SMARTUBE TOOLS

WERKZEUG SMART VERSTECKT // Mit den extrem leichten, aber robusten Smarttube Tools lassen sich die wichtigsten Werkzeuge, die man beim Biken braucht, einfach im Lenker verstauen. Das Minitool beinhaltet vier Sechskant und einen Torx 25 Aufsatz. Der Smarttube Kettenniet kommt mit Tubeless Repair Funktion, Tubeless Plugs und einer Aufnahme für ein Kettenschloss.
CLEVERLY HIDDEN TOOLS // With the extremely light but robust Smarttube tools, the most important tools you need when biking can be easily stored in the handlebars. The minitool includes four hexagons bits and a Torx 25. The Smarttube chain tool has a tubeless repair function, tubeless plugs and a magnetic mount for a chain lock.



VORBEREITET FÜR FAHRRADSTÄNDER // KICK STAND READY

VORBEREITET AUF ALLES // Falls ihr mal einen sicheren Stand braucht: Diese Bikes sind dafür vorbereitet.
PREPARED LIKE SECOND TO NONE // In case you need a safe stand at some point: These bikes are ready for an upgrade.



EIGHTPINS SATTELSTÜTZE // EIGHTPINS DROPPER POST

DIE REVOLUTIONIERTE SATTELSTÜTZE // Durch diese Sattelstütze kommt jeder Fahrer auf den Genuss des vollen Hubes, denn sie kann an jede Körpergröße und jeden Fahrsattel angepasst werden.
THE REVOLUTIONIZED DROPPER POST // With this seat post, every rider can enjoy the full stroke as it can be adapted to any height and riding style.



INTEGRIERTE FAHRRADSTÄNDER // INSTALLED KICK STAND

DER SICHERE STAND FÜR DEIN BIKE // Damit du dein Bike immer und überall sicher abstellst kannst, haben wir es mit einem Fahrradständer ausgestattet. Nie wieder nervige „Parkplatzsuche“.
YOUR BIKE STANDING SAFELY // To place your bike safely anytime and anywhere, we have equipped it with a secure kick stand. No more annoying search for a parking space.



SINGLE SPEED // SINGLE SPEED

WEIL EINFACH EINFACH IST // Kein Shifter, kein Schaltwerk mehr – weil weniger manchmal mehr ist, setzen wir bei einigen Bikes auf einen Single Speed Antrieb.
BECAUSE SIMPLY IS SIMPLE // No more shifter, no more rear derailleur - because less is sometimes more, we use a single speed drive for some bikes.



EXTRA STEIFE SCHUTZBLECHE // EXTRA STRONG FENDERS

CLEAN IM DOPPELTEN SINNE // Selbst am Schutzblech kann man tüfteln: Durch unsere extrem steife Schutzblech-Konstruktion können wir auf zusätzliche Streben verzichten. Das spart nicht nur Gewicht, sondern sorgt auch für eine super cleane Optik.
CLEAN IN BOTH SENSES // Even mudguards you can tinker with: Through our extremely stiff mudguard design we can do without additional straghtions. This not only saves weight, but also ensures a minimalist look.



MODULAR RAIL SYSTEM // MODULAR RAIL SYSTEM

SCHIENENSYSTEM ERSETZT FESTE SCHRAUBPUNKTE // Ermöglicht, unsere MRS Produkte sowie jegliche Accessoires an einer frei wählbaren Position im Bereich der Schiene zu montieren. Diese ist bei den HIGH Rahmen als lange Schiene, und bei den LOW Rahmen als zwei kurze am Unterrohr integriert.
RAIL SYSTEM REPLACES FIXED SCREWS // MRS products and any accessories can be mounted anywhere on the rail. For all HIGH frames this is integrated in the down tube as a long rail and for LOW frames as two short ones.



VORBEREITET FÜR SCHUTZBLECHE // FENDER READY

SAUBER BLEIBEN // Wer Matsch- und Wasserspritzer abhalten will, der kann unsere Rahmen unkompliziert mit Schutzblechen nachrüsten.
STAY CLEAN // Anyone who wants to keep mud and water splashes at bay can easily retrofit their bike with mudguards.



EINSATZBEREICHE // RANGE OF USE

Jedes Fahrrad wurde für einen bestimmten Gebrauch beziehungsweise Einsatzbereich entwickelt und gebaut. Dieser Abschnitt erklärt diese Einsatzbereiche und gibt Auskunft über das maximal zulässige Gesamtgewicht bzw. Fahrergewicht.

Das **Gesamtgewicht (A)** setzt sich zusammen aus dem Gewicht des Fahrrads, des fahrfertig bekleideten Fahrers und des Gepäcks.

Das **Fahrergewicht (B)** setzt sich zusammen aus dem Gewicht des fahrfertig bekleideten Fahrers und des Gepäcks.

Each bicycle is designed for a specific range of use. This section explains those ranges and the weight limits.

The **total weight (A)** equals the weight of the bicycle plus fully geared rider plus luggage.

The **riders weight (B)** equals the weight of the fully geared rider plus luggage.

A MAXIMAL ZULÄSSIGES GESAMTGEWICHT //
MAX. ALLOWED TOTAL WEIGHT

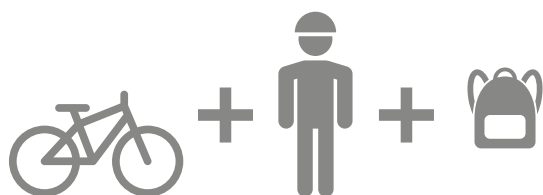

B MAXIMAL ZULÄSSIGES FAHRERGEWICHT //
MAX. ALLOWED RIDER'S WEIGHT

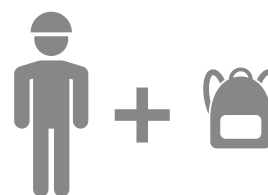

ACHTUNG

Fahrräder sind stets entsprechend ihrem zugelassenen Einsatzbereich zu verwenden. Wird ein Fahrrad höheren Belastungen ausgesetzt, als von uns in der jeweiligen Kategorie empfohlen, kann das zu Beschädigungen des Materials und sogar zum Bruch führen. Ein beschädigtes Fahrrad kann unkontrollierbar werden und dadurch schwere Stürze verursachen.

Beachten Sie auch die Betriebsanleitung des jeweiligen Fahrrads.

WARNING







Bikes always have to be used within and according to their range of use. If a bike is exposed to more stress than intended in its specific range of use, the bicycle and/or its parts may be damaged or break. A damaged or broken bike may be difficult or impossible to control and may cause severe crashes.

Always pay attention to the operating manual of the respective bicycle as well.







EINSATZBEREICHE // RANGE OF USE

MODELL // MODEL	KATEGORIE EINSATZBEREICH // RANGE OF USE CATEGORY	MAX. ZULÄSSIGES GESAMTGEWICHT (*max. zulässiges Fahrergewicht) // MAX. ALLOWED TOTAL WEIGHT (*max. allowed riders weight)
RIOT EN	4	120 kg
RIOT AM	4	120 kg
RIOT TRAIL	4	120 kg
NIRVANA 4X	4	120 kg
KATO FS	4	120 kg
RIOT YOUTH	4	120 kg
E-RIOT EN	4	120 kg
E-RIOT AM	4	120 kg
E-RIOT TRAIL	4	120 kg
PATH RIOT	4	120 kg
E-ASX 160	4	120 kg
E-ASX 130	4	120 kg
LECTOR FS	3	120 kg
LECTOR	3	120 kg
NIRVANA TRAIL	3	120 kg
NIRVANA TOUR	3	120 kg
KATO	3	120 kg
KATO EQ	3	120 kg
LANAO	3	120 kg
LANAO EQ	3	120 kg
KATO YOUTH	3	120 kg
KATO YOUTH EQ	3	120 kg
LANAO YOUTH	3	120 kg
LANAO YOUTH EQ	3	120 kg
ASKET	3	120 kg
ASKET EQ	3	120 kg
PATH ASKET	3	120 kg
E-TERU (PRO, ADVANCED, UNIVERSAL, ESSENTIAL)	3	130 kg
ASKET CF	2	120 kg
KATO 24	2	60 kg
KATO 24 EQ	2	60 kg
KATO 20	2	60 kg
LANAO 24	2	60 kg
LANAO 24 EQ	2	60 kg
LANAO 20	2	60 kg
SQUARE TREKKING	2	130 kg
SQUARE CROSS	2	130 kg
E-TERU	2	130 kg
E-TERU EQ	2	130 kg
POWERKID 16	0	30 kg
POWERKID 12	0	30 kg
POWERKIDDY 12	0	30 kg

EINSATZBEREICHE

Symbol	Fahrzeugkategorie	Nutzung
	<p>Fahrzeuge der Kategorie 0 sind in der Regel Kinderspielräder 12" und Kinderräder 12" und 16".</p>	<p>KATEGORIE 0:</p> <ul style="list-style-type: none"> - Für Kinder ab 3 Jahren - Verwendung nur unter Aufsicht Erziehungsberechtigter - Teilnahme an dem Straßenverkehr ist nicht gestattet - Teilnahme an Wettkämpfen ist nicht gestattet - Nicht für Sprünge und akrobatische Handlungen geeignet
	<p>Fahrzeuge der Kategorie 1 sind in der Regel Fahrräder, Pedelecs und S-Pedelecs des Typs Rennrad oder Fitness Bike (Urban Bike).</p>	<p>KATEGORIE 1:</p> <ul style="list-style-type: none"> - Ausschließlich für asphaltierte, betonierte oder gepflasterte Straßen und Wege - Permanenter Bodenkontakt der Laufräder muss gewährleistet sein - Die Teilnahme an Wettkämpfen ist gestattet - Nicht für Drops, Sprünge und akrobatische Handlungen geeignet
	<p>Fahrzeuge der Kategorie 2 sind in der Regel Fahrräder, Pedelecs und S-Pedelecs des Typs City-, Trekking-, Cross-Trekking- oder Lastenrad, außerdem Kinderräder 20" und Jugendräder 24".</p>	<p>KATEGORIE 2:</p> <ul style="list-style-type: none"> - Beinhaltet Kategorie 1 sowie befestigte und naturfeste Wege mit moderaten Steigungen - Absätze von bis zu 15 cm, z. B. Bordsteinkanten, können hinuntergefahren werden - Die Teilnahme an Wettkämpfen ist nicht gestattet - Nicht für Sprünge und akrobatische Handlungen geeignet
	<p>Fahrzeuge der Kategorie 3 sind in der Regel Fahrräder, Pedelecs und S-Pedelecs des Typs Mountainbike mit Einsatzzweck Cross Country, Marathon und Tour sowie Fahrräder aus den Bereichen Cyclo-Cross und All Track.</p>	<p>KATEGORIE 3:</p> <ul style="list-style-type: none"> - Beinhaltet Kategorien 1 und 2 sowie raue Trails mit kleineren Hindernissen und unbefestigte Strecken, die eine gute Fahrtechnik erfordern - Die Teilnahme an Wettkämpfen ist gestattet - Drops und Sprünge bis zu einer Höhe von max. 60 cm sind zulässig (unter der Voraussetzung entsprechender Fahrtechnik) - Nicht für akrobatische Handlungen geeignet
	<p>Fahrzeuge der Kategorie 4 sind in der Regel Fahrräder, Pedelecs und S-Pedelecs des Typs Mountainbike mit Einsatzzweck Allmountain.</p>	<p>KATEGORIE 4:</p> <ul style="list-style-type: none"> - Beinhaltet Kategorien 1, 2 und 3 - Größere Hindernisse und höhere Geschwindigkeiten setzen gesteigertes fahrerisches Können voraus - Die Teilnahme an Wettkämpfen ist gestattet - Drops und Sprünge bis zu einer Höhe von max. 120 cm sind zulässig (unter der Voraussetzung entsprechender Fahrtechnik) - Nicht für akrobatische Handlungen geeignet
	<p>Fahrzeuge der Kategorie 5 sind in der Regel Fahrräder, Pedelecs und S-Pedelecs des Typs Mountainbike mit Einsatzzweck Enduro/Freeride/Downhill.</p>	<p>KATEGORIE 5:</p> <ul style="list-style-type: none"> - Beinhaltet Kategorien 1, 2, 3 und 4 sowie sehr schnell gefahrenes und sehr anspruchsvolles Gelände mit extremen Steigungen - Sehr hohe Ansprüche an das fahrerische Können - Die Teilnahme an Wettkämpfen ist gestattet - Weite Sprünge und Drops sind zulässig (unter der Voraussetzung entsprechender Fahrtechnik) - Nicht für akrobatische Handlungen geeignet

RANGE OF USE

Symbol	Cycle category	Use
	<p>Category 0 cycles are generally 12" balance bikes and 12" or 16" children's bikes.</p>	<p>CATEGORY 0:</p> <ul style="list-style-type: none"> - For children aged 3 years and up - Only for use under the supervision of a parent or guardian - Not permitted on the road - Not permitted in competitions - Not suitable for jumps or acrobatics
	<p>Category 1 cycles are generally bikes, pedelecs and S-pedelecs in the style of racing bikes or fitness bikes (urban bikes).</p>	<p>CATEGORY 1:</p> <ul style="list-style-type: none"> - Solely for asphalt, concrete or paved roads and paths - Wheels must be kept in permanent contact with the ground - Permitted in competitions - Not suitable for drops, jumps or acrobatics
	<p>Category 2 cycles are generally bikes, pedelecs and S-pedelecs in the style of city, trekking, cross-trekking or cargo bikes, as well as 20" children's bikes and 24" junior bikes.</p>	<p>CATEGORY 2:</p> <ul style="list-style-type: none"> - Includes category 1, plus surfaced and naturally firm paths with moderate inclines - Can be ridden down steps of up to 15 cm / 5.9", e.g. kerbs - Not permitted in competitions - Not suitable for jumps or acrobatics
	<p>Category 3 cycles are generally bikes, pedelecs and S-pedelecs in the style of mountain bikes designed for cross-country, marathon and touring use, plus bikes in the cyclo-cross and all-track segments.</p>	<p>CATEGORY 3:</p> <ul style="list-style-type: none"> - Includes categories 1 and 2, plus rough trails with small obstacles, and unsurfaced routes that require good riding technique - Permitted in competitions - Drops and jumps permitted up to a max. height of 60 cm / 23.6" (with appropriate riding technique) - Not suitable for acrobatics
	<p>Category 4 cycles are generally bikes, pedelecs and S-pedelecs in the style of mountain bikes designed for all-mountain use.</p>	<p>CATEGORY 4:</p> <ul style="list-style-type: none"> - Includes categories 1, 2 and 3 - Larger obstacles and higher speeds require increased riding skills - Permitted in competitions - Drops and jumps permitted up to a max. height of 120 cm / 47.2" (with appropriate riding technique) - Not suitable for acrobatics
	<p>Category 5 cycles are generally bikes, pedelecs and S-pedelecs in the style of mountain bikes designed for enduro/freeride/downhill use.</p>	<p>CATEGORY 5:</p> <ul style="list-style-type: none"> - Includes categories 1, 2, 3 and 4, plus very fast and very demanding terrain with extreme inclines - Very high demands on riding skill - Permitted in competitions - Long drops and jumps permitted (with appropriate riding technique) - Not suitable for acrobatics



IMPRINT

Alle Angaben der GHOST-Bikes GmbH wie Preise, Größen, Gewichte, Farben einschließlich Lieferzeiten und/oder sonstigen Angaben erfolgen mit größter Sorgfalt. Die GHOST-Bikes GmbH übernimmt keine Gewähr für mögliche Abweichungen. Offensichtliche Fehler oder Irrtümer im Katalog sind für die GHOST-Bikes GmbH nicht bindend. Alle Preise sind unverbindliche Preisempfehlungen inklusive der gesetzlichen MwSt.

Aus Gründen der besseren Lesbarkeit wird bei Personenbezeichnungen und personenbezogenen Hauptwörtern in diesem Dealerbook die männliche Form verwendet. Entsprechende Begriffe gelten im Sinne der Gleichbehandlung grundsätzlich für alle Geschlechter. Die verkürzte Sprachform hat nur redaktionelle Gründe und beinhaltet keine Wertung.

FOTOS

Volker Martin, Florian Breitberger, Bruno Long, Christian Böhm, Stephan Wieser, Janik Steiner, Dan Griffiths, Syo Van Vliet, Jens Staudt, Attention Builders, Lars Veenstra, GHOST Marketing

DANK AN

Alle Mitarbeiter von GHOST-Bikes – jeden Einzelnen in unserer einmaligen Firma, der ein Teil dieses langen und manchmal auch harten Entwicklungsprozesses unserer Produkte war, die wir nun mit Stolz präsentieren.

Irrtümer, Änderungen und Druckfehler vorbehalten.
Bilder können vom Original abweichen.

GHOST-Bikes GmbH ist ein Mitglied der ACCELL GROUP.

© 2023 GHOST Bikes

Unter Umständen sind nicht alle in diesem Katalog gezeigten Produkte in allen Regionen erhältlich, bitte kontaktiere dazu dein Vertriebsteam.

Weiterführende Informationen und Neuigkeiten findest Du unter www.ghost-bikes.com.

All representations made by GHOST-Bikes GmbH regarding numbers, sizes, weights, colours including delivery times and/or other specifications are made with care. GHOST-Bikes GmbH does not guarantee that there will not be any deviations. Obvious mistakes or errors in the catalogue are not binding on GHOST-Bikes GmbH. All prices are recommended retail prices incl. VAT.

For reasons of better readability, the masculine form is used for personal names and personal nouns in this dealerbook. Corresponding terms apply to all genders in the sense of equal treatment. The abbreviated language form has only editorial reasons and does not imply any valuation.

PHOTOS

Volker Martin, Florian Breitberger, Bruno Long, Christian Böhm, Stephan Wieser, Janik Steiner, Dan Griffiths, Syo Van Vliet, Jens Staudt, Attention Builders, Lars Veenstra, GHOST Marketing

THANKS TO

All employees of GHOST-Bikes – to each one of you in our unique company who was a part of this long and sometimes difficult development process of our products which we now proudly present.

We are not liable for errors, changes or misprints.
Images might not represent the original.

GHOST-Bikes GmbH is a member of ACCELL GROUP.

© 2023 GHOST Bikes

Under certain circumstances, not all of the products shown in this catalogue might be available in all regions. Please contact your sales department for more information.

For more detailed information and other news, please visit our website at www.ghost-bikes.com.

GHOST-Bikes GmbH

An der Tongrube 3
95652 Waldsassen
Germany

Tel: +49 (9632) 9255-0
Fax: +49 (9632) 9255-116
Email: info@ghost-bikes.de
Web: ghost-bikes.com



BUILT FOR THE ROUGH

*GHOST
150H9*

Art. Nr.: KAT466

GHOST-BIKES.COM