



GHOST

Lieber GHOST-Händler,

vor fast einem Vierteljahrhundert durfte der erste Kunde ein GHOST Bike aus den Händen unserer Firmengründer Uwe und Klaus entgegennehmen.

Aus Händen, die vielleicht noch etwas dreckig und ölverschmiert vom Aufbau waren. Mit Stolz wurde das Rad verkauft und mit Begeisterung vom Kunden gefahren.

Auch wenn sich an den Bikes in den letzten Jahren viel geändert hat, eines sollte immer gleich bleiben:

Die Begeisterung, die man auf einem GHOST Bike erfährt. Diese Begeisterung im Verkauf und in der Beratung zu vermitteln, für ein Produkt zu brennen und dessen Vorzüge zu kennen, das ist eure Aufgabe und euer tägliches Geschäft.

Dafür möchten wir uns nicht nur bedanken, sondern euch auch bestmöglich dabei unterstützen.

Euer GHOST Team

Dear GHOST dealer,

Nearly a quarter century ago, our company founders Uwe and Klaus personally sold and handed a GHOST bike to their first customer. Their hands probably still were a little dirty and greasy from assembling it.

But they were brimming with pride for their bike – which the customer then rode with great excitement and enthusiasm. Even though the bikes have changed a lot over the years, one thing remains the same:

The excitement you experience on a GHOST bike. To convey this very feeling during every customer consultation and sales process, to be inspired by a product and to know all its strengths is your job and is what you do every day.

We not only want to thank you for that, but also want to give you the best possible support.

Cheers,

Your GHOST team



Subject to errors, changes and printing errors. Pictures can differ from the original product.
For more detailed information and other news, please visit our website at www.ghost-bikes.com.

Irrtümer, Änderungen und Druckfehler vorbehalten. Bilder können vom Original abweichen.
Weiterführende Informationen und Neuigkeiten finden Sie unter www.ghost-bikes.com.













A person on a mountain bike is captured in mid-air, jumping over a large rock in a forest. The scene is bathed in a warm, golden light, likely from a low sun, creating a hazy, atmospheric effect. The person and their bike are silhouetted against the bright background. The number '18' is prominently displayed in white on the right side of the image, with a horizontal line underneath it.

18

GHOST

BIKE ANATOMY / BIKE ANATOMIE



- | | | | |
|--|---|---|--|
|  FRAME
RAHMEN |  FRONT DERAILLEUR
UMWERFER |  RIM
FELGE |  BOTTOM BRACKET
INNENLAGER |
|  FORK AND FRONT TRAVEL
GABEL UND FEDERWEG VORNE |  SHIFTER
SCHALTHEBEL |  FRONT HUB
NABE VORNE |  HANGER
SCHALTAUGE |
|  SHOCK AND REAR TRAVEL
FEDERELEMENT UND FEDERWEG HINTEN |  CRANKSET
KURBELSATZ |  REAR HUB
NABE HINTEN |  AVAILABLE FRAME SIZES
ERHÄLTICHE RAHMENGRÖSSEN |
|  STEM
VORBAU |  CASSETTE
KASSETTE |  SEATPOST
SATTELSTÜTZE | |
|  HANDLEBAR
LENKER |  BRAKES
BREMSEN |  SADDLE
SATTEL | |
|  REAR DERAILLEUR
SCHALTWERK |  TIRES
REIFEN |  HEADSET
STEUERSATZ | |

BIKE ANATOMY / BIKE ANATOMIE



- | | | | |
|---|--------------------------|------------------------------|---|
| FRAME
RAHMEN | CRANKSET
KURBELSATZ | SADDLE
SATTEL | BATTERY
BATTERIE |
| FORK AND FRONT TRAVEL
GABEL UND FEDERWEG VORNE | CASSETTE
KASSETTE | CARRIER
GEPÄCKTRÄGER | CHARGER
LADEGERÄT |
| SHOCK AND REAR TRAVEL
FEDERELEMENT UND FEDERWEG HINTEN | BRAKES
BREMSEN | FENDERS
SCHUTZBLECHE | HEADSET
STEUERSATZ |
| STEM
VORBAU | TIRES
REIFEN | KICK STAND
STÄNDER | BOTTOM BRACKET
INNENLAGER |
| HANDLEBAR
LENKER | RIM
FELGE | LIGHTS FRONT
SCHEINWERFER | HANGER
SCHALTAUGE |
| REAR DERAILLEUR
SCHALTWERK | FRONT HUB
NABE VORNE | LIGHTS REAR
RÜCKLICHT | AVAILABLE FRAME SIZES
ERHÄLTICHE RAHMENGRÖSSEN |
| FRONT DERAILLEUR
UMWERFER | REAR HUB
NABE HINTEN | DISPLAY
DISPLAY | |
| SHIFTER
SCHALTHEBEL | SEATPOST
SATTELSTÜTZE | MOTOR
MOTOR | |

TECHNOLOGY GLOSSARY / TECHNIK LEXIKON



RIOT shape //
RIOT Shape



RIOT link //
RIOT Link



4-bar-linkage //
Viergelenk Hinterbau



Full complement bearings //
Vollkugelige Industrielager



Composite bushing //
Komposit Gleitlager



Hydroformed tubeset //
Hydrogeformte Rohrsätze



Carbon flex stays //
Carbon Flex Stays



Forged dropout //
Geschmiedete Ausfallenden



Forged yoke // Geschmiedetes
Kettenstrebeyoke



Disconnect brake mount //
Disconnect Brake Mount



GHOST fork system //
GHOST Gabelsystem



LECTOR fork system //
LECTOR Gabelsystem



Internal cable routing //
Innenverlegte Züge



Integrated cable routing //
Integrierte Kabelführung



ISCG 05 //
ISCG 05



Post mount //
Post Mount Aufnahme



Through-axle standard //
Steckachsen Standard



HQ-decals //
Unterlack Decals



Frame protection //
Rahmenschutz



Boost standard //
Boost Standard



29" compatible //
29" kompatibel



27.5+ compatible //
27.5+ kompatibel



Race ready //
Race ready



UCI conform //
UCI konform



FEM calculated //
FEM berechnet



Bottlecase ready //
Vorbereitet für
Trinkflaschenhalter



Ready for dropper seatpost //
Vorbereitet für innenverlegte
Teleskopstütze



Shimano Steps 8000 //
Shimano Steps 8000 //



BOSCH CX //
BOSCH CX



Extra strong battery //
Extra starke Batterie



Integrated battery //
Integrierter Batterie



HybRide MXer concept //
HybRide MXer Konzept



Smart app //
Smart App



Disc brake //
Scheibenbremse



Coil shock //
Stahlfederdämpfer



1by drivetrain //
Einfach Antrieb



Gearbox drivetrain //
Getriebschaltung (Pinion)



Dropper post //
Teleskopstütze



AMR bag system //
AMR Taschen-System



Hub dynamo //
Nabendynamo



Integrated lights //
Integrierte Beleuchtung



USB charger //
USB Ladebuchse



Kick stand ready //
Vorbereitet für Fahrradständer



Extra strong fenders //
Extra steife Schutzbleche



Fender ready //
Vorbereitet für Schutzbleche



Integrated carrier //
Integrierter Gepäckträger



Integrated carrier for panniers //
Integrierter Gepäckträger
für Seitentaschen

TECHNOLOGY GLOSSARY / TECHNIK LEXIKON



Lightweight Carbon



Ultralightweight Carbon



Aluminum



Ultralightweight Carbon,
Lightweight Carbon



Ultralightweight Carbon,
Lightweight Carbon, Aluminum



Lightweight Carbon,
Aluminum



Wheelsize 12 inch //
Laufradgröße 12 Zoll



Wheelsize 16 inch //
Laufradgröße 16 Zoll



Wheelsize 20 inch //
Laufradgröße 20 Zoll



Wheelsize 24 inch //
Laufradgröße 24 Zoll



Wheelsize 26 inch //
Laufradgröße 26 Zoll



Wheelsize 27.5 inch //
Laufradgröße 27.5 Zoll



Wheelsize 27.5 + inch //
Laufradgröße 27.5 + Zoll



Wheelsize 28 inch //
Laufradgröße 28 Zoll



Wheelsize 29 inch //
Laufradgröße 29 Zoll



Wheelsizes 16, 12 inch //
Laufradgrößen 16, 12 Zoll



Wheelsizes 24, 20 inch //
Laufradgrößen 24, 20 Zoll



Wheelsizes 29, 27.5, 26 inch //
Laufradgrößen 29, 27.5, 26 Zoll

PATHRIDER

LIGHT STEEL COIL SPRING SHOCK FOR MAXIMUM SUSPENSION PERFORMANCE // LEICHTER STAHLFEDERDÄMPFER FÜR OPTIMALE FAHRWERKS-PERFORMANCE



EXCLUSIVE CANE CREEK SIGNATURE ENDURO MODEL // EXKLUSIVES CANE CREEK SIGNATURE ENDURO-MODELL



EXTREMELY LIGHTWEIGHT AND STIFF UC CARBON FRAME // SUPERLEICHTER UND STEIFER UC-CARBONRAHMEN

RIOT-LINK FOR MAXIMUM EFFICIENCY AND POWER // RIOT-LINK FÜR MAXIMALE EFFIZIENZ UND POTENZ



SRAM XO-1 1X12 EAGLE DRIVETRAIN // SRAM XO-1 1X12 EAGLE-ANTRIEB



// ENDURO / RACE

FEATURES



CHARACTERISTICS

- ▶ Extraordinary steering precision
- ▶ Unrivalled propulsion efficiency with equally powerful traction
- ▶ Optimum use of travel thanks to the homogenous Cane Creek suspension
- ▶ Designed for putting down the best race times and KOMs on home trails

CHARAKTERISTIK

- ▶ Außergewöhnliche Lenkpräzision
- ▶ Konkurrenzlose Antriebseffizienz bei gleichermaßen starker Traktion
- ▶ Ideale Ausnutzung des Federwegs dank homogenem Cane Creek-Fahrwerk
- ▶ Auf Bestzeiten im Rennen und KOMs auf den Hometrails ausgelegt

TARGET GROUP

- ▶ Technically skilled Enduro racers, focused on the fastest times

ZIELGRUPPE

- ▶ Versierte Enduro-Racer mit klarem Fokus auf Bestzeiten



PATHRIOT

// GEOMETRY AND DATA CHARTS / GEOMETRIE UND TECHNISCHE DATEN

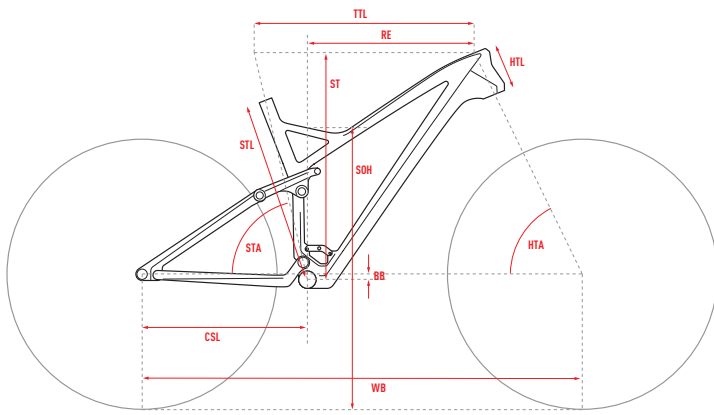

ALL DIMENSIONS IN MM (EXCEPT HTA AND STA IN °)

ALLE MASSE IN MM (AUSNAHME HTA UND STA IN °)

- STL** SEAT TUBE LENGTH
SITZROHRLÄNGE
- CSL** CHAINSTAY LENGTH
KETTENSTREBENLÄNGE
- TTL** TOP TUBE LENGTH
OBERROHRLÄNGE
- HTL** HEADTUBE LENGTH
STEUERROHRLÄNGE
- HTA** HEADTUBE ANGLE
STEUERROHRWINKEL
- STA** SEATTUBE ANGLE
SITZROHRWINKEL
- BB** BB DROP
TRETLAGERABSSENKUNG
- WB** WHEELBASE
RADSTAND
- ST** STACK
STACK
- RE** REACH
REACH
- SOH** STANDOVER HEIGHT
ÜBERSTANDSHÖHE
- SD** HEAD SET DIAMETER (UPPER / LOWER)
STEUERSATZDURCHMESSER (OBEN / UNTEN)
- AS** AXLE STANDARD (REAR / FRONT)
ACHSENSTANDARD (HINTEN / VORNE)
- BS** BOTTOM BRACKET STANDARD
TRETLAGERSTANDARD
- SD** SEAT POST DIAMETER
SITZELSTÜTZENDURCHMESSER
- SH** SHOCK HARDWARE (Ø 8MM)
DÄMPFERBUCHSENMASSE (Ø 8MM)
- SL** SHOCK LENGTH
DÄMPFEREINBAULÄNGE
- ST** SHOCK TRAVEL
DÄMPFERHUB
- FF** FRONT FORK TRAVEL
FEDERWEG VORNE
- FR** REAR WHEEL TRAVEL
FEDERWEG HINTEN
- MS** MIN SADDLE HEIGHT
MIN SITZELHÖHE
- MX** MAX SADDLE HEIGHT
MAX SITZELHÖHE
- MI** MIN INSEAM
MIN SCHRITTLÄNGE
- MX** MAX INSEAM
MAX SCHRITTLÄNGE
- SL** STEM LENGTH
VORBAULÄNGE
- HW** HANDLEBAR WIDTH
LENKERBREITE
- CL** CRANK LENGTH
KURBELLÄNGE
- SM** SEATTUBE BOTTLE MOUNT
FLASCHE SATTELROHR
- DM** DOWNTUBE BOTTLE MOUNT
FLASCHE UNTERROHR

STL CSL TTL HTL HTA STA BB WB ST RE SOH

PATHRIOT 8.7 UC U

	STL	CSL	TTL	HTL	HTA	STA	BB	WB	ST	RE	SOH																	
S	440	425	584	120	65	76	14	1180	616	430	732	ZS44/ZS56	142/110	PressFit 92	31.6	25,4/16	200	57	170	150	50	780	170	/	0.75			
M	460	425	604	130	65	76	14	1202	625	447	752	ZS44/ZS56	142/110	PressFit 92	31.6	25,4/16	200	57	170	150	50	780	170	/	0.75			
L	480	425	624	140	65	76	14	1223	634	465	772	ZS44/ZS56	142/110	PressFit 92	31.6	25,4/16	200	57	170	150	50	780	170	/	0.75			



FLAT // night black / spectra yellow / woodland tan



MODEL HIGHLIGHTS

- ▶ New 170 mm travel Cane Creek Helm Enduro fork
- ▶ All-out race specific setup
- ▶ High-end components

MODELL HIGHLIGHTS

- ▶ Neue 170 mm Cane Creek Helm Endurogabel
- ▶ Kompromisslos auf Race getrimmt
- ▶ Hochwertige Ausstattung

PATHRIOT UC	SRAM X01 Eagle 12-S	SRAM Code RSC 4/4 Piston 200/180 mm Disc	HS0008
Cane Creek Helm 170 mm	Cane Creek DB Coil CS 150 mm	Maxxis Minion DHF 3C MaxxTerra Exo 27.5x2.5 // Maxxis Minion DHR II Exo 27.5x2.4	PressFit 92 mm
Syntace Megaforce2 Dia. 31.8 mm	SRAM GX Eagle	Syntace M Wheelset 33mm 15x110 mm // Syntace M Wheelset 33mm 12x142 mm SRAM XD	FRH60057
Syntace Vector 780 mm Rise 20 mm Dia. 31.8 mm	Truvativ Descendant Carbon Eagle X-Sync 34T	Rock Shox Reverb Stealth 31.6 mm	S-M-L
	SRAM XG 1295 10-50	SD6 Fly Mountain	

SIZE	ARTICLENUMBER	NOTES
SIZE S	18PA1001	
SIZE M	18PA1002	
SIZE L	18PA1003	



// TRAIL / RACE

FEATURES



CHARACTERISTICS

- ▶ Fascinatingly efficient in propelling and precise in steering
- ▶ Efficient, yet very sensitive suspension with RIOT-Link
- ▶ Impressively easy handling
- ▶ Lightning fast acceleration

CHARAKTERISTIK

- ▶ Faszinierend effizient im Antritt und präzise beim Lenken
- ▶ Effizientes, aber dennoch sehr sensibles Fahrwerk mit RIOT-Link
- ▶ Beeindruckend leichtfüßiges Handling
- ▶ Blitzschnell in der Beschleunigung

TARGET GROUP

- ▶ Ambitious trail bikers who strive for a KOM on every ride they take

ZIELGRUPPE

- ▶ Ambitionierte Trailbiker, die sich bei jeder Ausfahrt mit einem KOM belohnen möchten

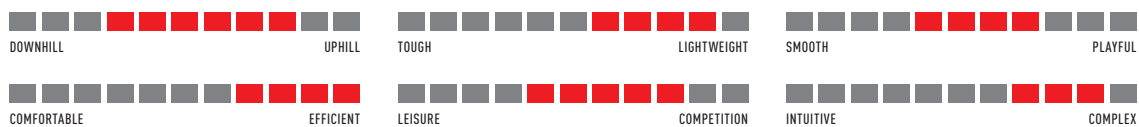

// GEOMETRY AND DATA CHARTS / GEOMETRIE UND TECHNISCHE DATEN

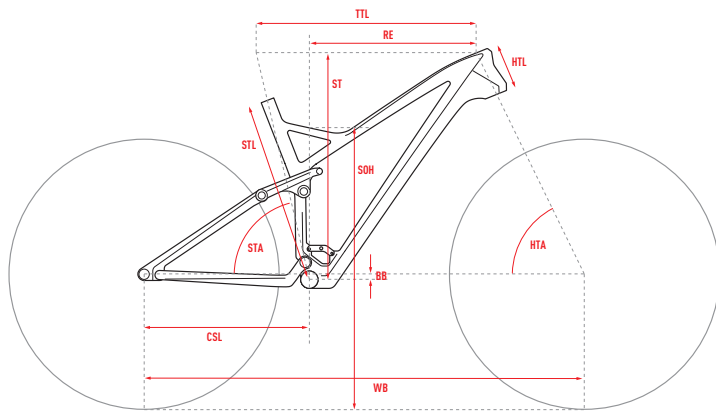









ALL DIMENSIONS IN MM (EXCEPT HTA AND STA IN °)

ALLE MASSE IN MM (AUSNAHME HTA UND STA IN °)

- STL** SEAT TUBE LENGTH
SITZROHRLÄNGE
- CSL** CHAINSTAY LENGTH
KETTENSTREBENLÄNGE
- TTL** TOP TUBE LENGTH
OBERROHRLÄNGE
- HTL** HEADTUBE LENGTH
STEUERROHRLÄNGE
- HTA** HEADTUBE ANGLE
STEUERROHRWINKEL
- STA** SEATTUBE ANGLE
SITZROHRWINKEL
- BB** BB DROP
TRETLAGERABSSENKUNG
- WB** WHEELBASE
RADSTAND
- ST** STACK
STACK
- RE** REACH
REACH
- SOH** STANDOVER HEIGHT
ÜBERSTANDSHÖHE
-  **HEAD SET DIAMETER (UPPER / LOWER)**
STEUERSATZDURCHMESSER (OBEN / UNTEN)
-  **AXLE STANDARD (REAR / FRONT)**
ACHSENSTANDARD (HINTEN / VORNE)
-  **BOTTOM BRACKET STANDARD**
TRETLAGERSTANDARD
-  **SEAT POST DIAMETER**
SITZSTÜTZENDURCHMESSER
-  **SHOCK HARDWARE (Ø 8MM)**
DÄMPFERBUCHSENMASSE (Ø 8MM)
-  **SHOCK LENGTH**
DÄMPFEREINBAULÄNGE
-  **SHOCK TRAVEL**
DÄMPFERHUB
-  **FRONT FORK TRAVEL**
FEDERWEG VORNE
-  **REAR WHEEL TRAVEL**
FEDERWEG HINTEN
-  **MIN SADDLE HEIGHT**
MIN SITZELHÖHE
-  **MAX SADDLE HEIGHT**
MAX SITZELHÖHE
-  **MIN INSEAM**
MIN SCHRITTLÄNGE
-  **MAX INSEAM**
MAX SCHRITTLÄNGE
-  **STEM LENGTH**
VORBAULÄNGE
-  **HANDLEBAR WIDTH**
LENKERBREITE
-  **CRANK LENGTH**
KURBELLÄNGE
-  **SEATTUBE BOTTLE MOUNT**
FLASCHE SATTELROHR
-  **DOWNTUBE BOTTLE MOUNT**
FLASCHE UNTERROHR

STL CSL TTL HTL HTA STA BB WB ST RE SOH             

RIOT 8.7 UC U

	STL	CSL	TTL	HTL	HTA	STA	BB	WB	ST	RE	SOH																		
S	440	430	590	110	67	73	3	1130	590	407	735	ZS44/ZS56	142/110	PressFit 92	31.6	25,4/16	190	51	150	130	50	780	175	/	0.75				
M	480	430	615	120	67	73	3	1155	600	427	755	ZS44/ZS56	142/110	PressFit 92	31.6	25,4/16	190	51	150	130	50	780	175	/	0.75				
L	520	430	640	130	67	73	3	1182	610	450	782	ZS44/ZS56	142/110	PressFit 92	31.6	25,4/16	190	51	150	130	50	780	175	/	0.75				



FLAT // night black / spectra yellow / woodland tan

27.5 UC **RIOT** 8.7



MODEL HIGHLIGHTS

- ▶ Incredibly agile handling thanks to balanced geometry
- ▶ Lightweight and efficient trail bike
- ▶ SRAM Eagle 1x12 drivetrain with 500 % bandwidth

MODELL HIGHLIGHTS

- ▶ Enorm agiles Handling dank ausbalancierter Geometrie
- ▶ Leichtes und effizientes Trailbike
- ▶ SRAM Eagle 1x12 Antrieb mit 500 % Bandbreite

RIOT UC	SRAM X01 Eagle 12-S	SRAM Guide RSC 4/4 Piston 200/180 mm Disc	HS0007
Cane Creek Helm 150 mm	-	Maxxis Minion DHR II 3C MaxxiTerra Exo 27.5x2.3 // Maxxis Minion SS Exo 27.5x2.3	PressFit 92 mm
Cane Creek Inline Coil CS 130 mm	SRAM GX Eagle	Syntace M Wheelset 28mm 15x110 mm // Syntace M Wheelset 28mm 12x142 mm SRAM XD	FRH60057
Syntace Megaforce2 Dia. 31.8 mm	Truvativ Descendant Carbon Eagle X-Sync 34T	Rock Shox Reverb Stealth 31.6 mm	S-M-L
Syntace Vector 780 mm Rise 20 mm Dia. 31.8 mm	SRAM XG 1295 10-50	SD6 Fly Mountain	

SIZE	ARTICLENUMBER	NOTES
SIZE S	18R11001	
SIZE M	18R11002	
SIZE L	18R11003	

HAMR X



⊕ COMES WITH ADAPTABLE AMR BAG PACKING SYSTEM // KOMMT MIT WANDLUNGSFÄHIGEM AMR-TASCHENSYSTEM

⊕ USB PORT FOR CHARGING ELECTRONICS (GPS, LIGHTING ETC.) // USB-PORT FÜR MOBILES LADEN ELEKTRONISCHER ENDGERÄTE (GPS, BELEUCHTUNG ETC.)

⊕ STEEL COIL SPRING SHOCK FOR MAXIMUM RELIABILITY AND BEST POSSIBLE COMFORT // STAHLFEDERDÄMPFER FÜR HÖCHSTE ZUVERLÄSSIGKEIT UND BESTEN KOMFORT

⊕ 27.5"- WHEELSET FOR SAFE HANDLING AND COMFORTABLE ROLL-OVER QUALITIES // 27.5"-BEREIFUNG FÜR SICHERES HANDLING UND KOMFORTABLES ÜBERROLLVERHALTEN

⊕ LOW MAINTENANCE ENCLOSED PINION DRIVETRAIN // GEKAPSELTER, WARTUNGSSARMER GETRIEBEANTRIEB VON PINION

// BACKCOUNTRY / ADVENTURE

FEATURES



CHARACTERISTICS

- ▶ Extra robust long distance bike with reliable components
- ▶ Thought-out detailed solutions for self-sufficient multi-day tours
- ▶ Single-trail oriented adventure bike which does not shy away from wild trail outings either
- ▶ Great stability, even with fully loaded bags
- ▶ The AMR bag packing system offers a lot of clever storage space for your belongings

CHARAKTERISTIK

- ▶ Besonders robustes Langstreckenbike mit zuverlässigen Anbauteilen
- ▶ Ausgefeilte Detaillösungen für autarke Mehrtagestouren
- ▶ Singletrail-orientiertes Abenteuerbike, das auch vor wilden Trail-Ausfahrten nicht zurückschreckt
- ▶ Hohe Fahrstabilität auch bei voller Ladung der Gepäcktaschen
- ▶ Smarter Stauraum für Gepäck im AMR-Taschensystem

TARGET GROUP

- ▶ Explorers who are looking for the thrill of self-determined freedom of mobility and who know how to benefit from clever detailed solutions



ZIELGRUPPE

- ▶ Abenteuerer, die den Genuss der selbstbestimmten Bewegungsfreiheit suchen und smarte Detaillösungen für sich zu nutzen wissen

HAMR X

// GEOMETRY AND DATA CHARTS / GEOMETRIE UND TECHNISCHE DATEN

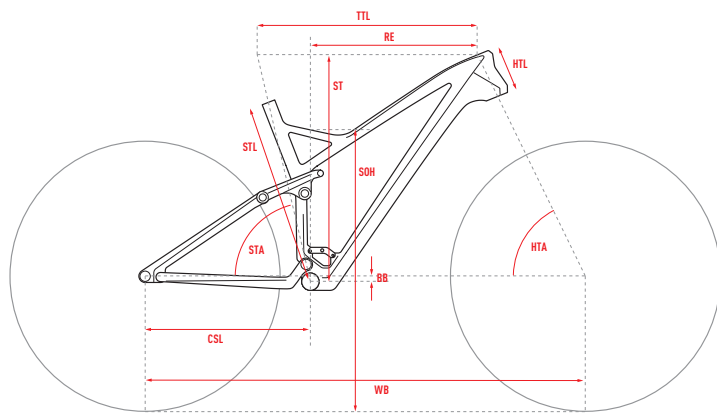

ALL DIMENSIONS IN MM (EXCEPT HTA AND STA IN °)

ALLE MASSE IN MM (AUSNAHME HTA UND STA IN °)

- STL** SEAT TUBE LENGTH
SITZROHRLÄNGE
- CSL** CHAINSTAY LENGTH
KETTENSTREBENLÄNGE
- TTL** TOP TUBE LENGTH
OBERROHRLÄNGE
- HTL** HEADTUBE LENGTH
STEUERROHRLÄNGE
- HTA** HEADTUBE ANGLE
STEUERROHRWINKEL
- STA** SEATTUBE ANGLE
SITZROHRWINKEL
- BB** BB DROP
TRETLAGERABSSENKUNG
- WB** WHEELBASE
RADSTAND
- ST** STACK
STACK
- RE** REACH
REACH
- SOH** STANDOVER HEIGHT
ÜBERSTANDSHÖHE
- SD** HEAD SET DIAMETER (UPPER / LOWER)
STEUERSATZDURCHMESSER (OBEN / UNTEN)
- AS** AXLE STANDARD (REAR / FRONT)
ACHSENSTANDARD (HINTEN / VORNE)
- BS** BOTTOM BRACKET STANDARD
TRETLAGERSTANDARD
- SP** SEAT POST DIAMETER
SITZELSTÜTZENDURCHMESSER
- SH** SHOCK HARDWARE (Ø 8MM)
DÄMPFERBUCHSENMASSE (Ø 8MM)
- SL** SHOCK LENGTH
DÄMPFEREINBAULÄNGE
- ST** SHOCK TRAVEL
DÄMPFERHUB
- FF** FRONT FORK TRAVEL
FEDERWEG VORNE
- FR** REAR WHEEL TRAVEL
FEDERWEG HINTEN
- MS** MIN SADDLE HEIGHT
MIN SITZTELHÖHE
- MX** MAX SADDLE HEIGHT
MAX SITZTELHÖHE
- MI** MIN INSEAM
MIN SCHRITTLÄNGE
- MX** MAX INSEAM
MAX SCHRITTLÄNGE
- SL** STEM LENGTH
VORBAULÄNGE
- HW** HANDLEBAR WIDTH
LENKERBREITE
- CL** CRANK LENGTH
KURBELLÄNGE
- SM** SEATTUBE BOTTLE MOUNT
FLASCHE SATTELROHR
- DM** DOWNTUBE BOTTLE MOUNT
FLASCHE UNTERROHR

STL CSL TTL HTL HTA STA BB WB ST RE SOH

HAMR X 9.7+ ALU

	STL	CSL	TTL	HTL	HTA	STA	BB	WB	ST	RE	SOH																		
S	420	438	565	110	67	75.5	38	1144	614	406	729	ZS44/ZS56	148/110	Pinion	31.6	30/30	210	55	140	140	50	800	175	/	0.5				
M	460	438	590	120	67	75.5	38	1171	623	429	738	ZS44/ZS56	148/110	Pinion	31.6	30/30	210	55	140	140	50	800	175	/	0.5				
L	500	438	615	120	67	75.5	38	1196	623	454	752	ZS44/ZS56	148/110	Pinion	31.6	30/30	210	55	140	140	50	800	175	/	0.5				



MODEL HIGHLIGHTS

- ▶ Pinion P1.18 gear system
- ▶ AMR pack system included
- ▶ Boost hub dynamo with USB port at the stem

MODELL HIGHLIGHTS

- ▶ Pinion P1.18 Getriebe
- ▶ AMR-Taschensystem inklusive
- ▶ Boost-Nabendynamo mit USB-Ladebuchse am Vorbau

HAMR AL Pinion	-	Race Face ARC 40 584x40 mm 32H // Race Face ARC 40 584x40 mm 32H	Pinion
Rock Shox Pike RCT3 Solo Air 140 mm	Pinion P1.18	Shutter Precision Dynamo Hub 15x110 mm	FRH0059
Cane Creek InLine Coil CS 140 mm	Pinion 30T	Pinion H1.R 12x148 mm	S-M-L
Race Face Atlas Dia. 35 mm	Pinion 26T	Rock Shox Reverb Stealth 31.6 mm	
Race Face Atlas 800 mm Rise 20 mm Dia. 35 mm	SRAM Guide RS 4/4 Piston 200/180 mm Disc	SD6 Fly Mountain	
Pinion P1.18	Schwalbe Nobby Nic TrailStar 27.5x2.8 // Schwalbe Rocket Ron PaceStar 27.5x2.8	16012	

SIZE	ARTICLENUMBER	NOTES
SIZE S	18HA1001	
SIZE M	18HA1002	
SIZE L	18HA1003	



// BACKCOUNTRY / ALLROUND

FEATURES



CHARACTERISTICS

- ▶ Particularly robust long-distance bike with reliable components
- ▶ Comfort-oriented adventure bike which conveys a tremendous feeling of safety, especially in terrain
- ▶ Versatile know-it-all which also works great with 29" wheels on long tours off the rough trails

CHARAKTERISTIK

- ▶ Besonders robustes Langstreckenbike mit zuverlässigen Anbauteilen
- ▶ Komfort-orientiertes Abenteuerbike, das insbesondere im Gelände besonders viel Sicherheit vermittelt
- ▶ Vielseitiger Alleskönner, der für lange Touren abseits ruppiger Trails auch mit 29"-Laufrädern funktioniert

TARGET GROUP

- ▶ Self-proclaimed pleasure bikers looking for relaxation outdoors and who are set on discovering unknown territory



ZIELGRUPPE

- ▶ Selbstbestimmte Genuss-Biker, die Erholung in freier Natur suchen und in unentdeckte Regionen vordringen möchten

// GEOMETRY AND DATA CHARTS / GEOMETRIE UND TECHNISCHE DATEN

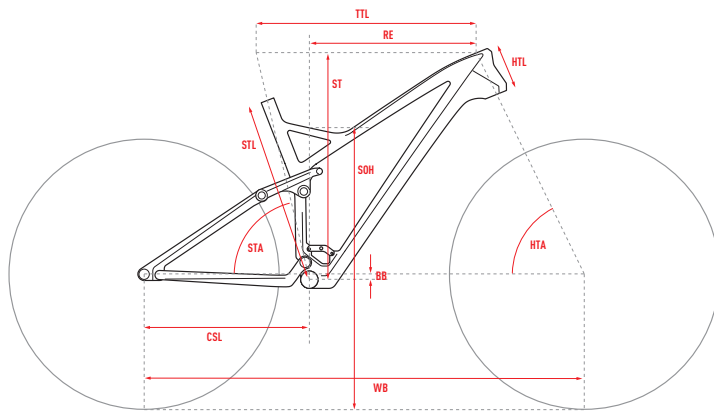













ALL DIMENSIONS IN MM (EXCEPT HTA AND STA IN °)

ALLE MASSE IN MM (AUSNAHME HTA UND STA IN °)

- STL** SEAT TUBE LENGTH
SITZROHRLÄNGE
- CSL** CHAINSTAY LENGTH
KETTENSTREBENLÄNGE
- TTL** TOP TUBE LENGTH
OBERROHRLÄNGE
- HTL** HEADTUBE LENGTH
STEUERROHRLÄNGE
- HTA** HEADTUBE ANGLE
STEUERROHRWINKEL
- STA** SEATTUBE ANGLE
SITZROHRWINKEL
- BB** BB DROP
TRETLAGERABSSENKUNG
- WB** WHEELBASE
RADSTAND
- ST** STACK
STACK
- RE** REACH
REACH
- SOH** STANDOVER HEIGHT
ÜBERSTANDSHÖHE
-  **HEAD SET DIAMETER (UPPER / LOWER)**
STEUERSATZDURCHMESSER (OBEN / UNTEN)
-  **AXLE STANDARD (REAR / FRONT)**
ACHSENSTANDARD (HINTEN / VORNE)
-  **BOTTOM BRACKET STANDARD**
TRETLAGERSTANDARD
-  **SEAT POST DIAMETER**
SITZSTÜTZENDURCHMESSER
-  **SHOCK HARDWARE (Ø 8MM)**
DÄMPFERBUCHSENMASSE (Ø 8MM)
-  **SHOCK LENGTH**
DÄMPFEREINBAULÄNGE
-  **SHOCK TRAVEL**
DÄMPFERHUB
-  **FRONT FORK TRAVEL**
FEDERWEG VORNE
-  **REAR WHEEL TRAVEL**
FEDERWEG HINTEN
-  **MIN SADDLE HEIGHT**
MIN SITZELHÖHE
-  **MAX SADDLE HEIGHT**
MAX SITZELHÖHE
-  **MIN INSEAM**
MIN SCHRITTLÄNGE
-  **MAX INSEAM**
MAX SCHRITTLÄNGE
-  **STEM LENGTH**
VORBAULÄNGE
-  **HANDLEBAR WIDTH**
LENKERBREITE
-  **CRANK LENGTH**
KURBELLÄNGE
-  **SEATTUBE BOTTLE MOUNT**
FLASCHE SATTELROHR
-  **DOWNTUBE BOTTLE MOUNT**
FLASCHE UNTERROHR

STL CSL TTL HTL HTA STA BB WB ST RE SOH             

HAMR 6.7+ AL U

	STL	CSL	TTL	HTL	HTA	STA	BB	WB	ST	RE	SOH																		
S	420	438	567	100	67.5	75	33	1136	614	401	731	ZS44/ZS56	148/110	PressFit 92	31.6	30/30	210	50	140	130	55	760	175	/	0.5				
M	460	438	593	105	67.5	75	33	1162	617	425	742	ZS44/ZS56	148/110	PressFit 92	31.6	30/30	210	50	140	130	55	760	175	/	0.5				
L	480	438	619	110	67.5	75	33	1188	623	449	744	ZS44/ZS56	148/110	PressFit 92	31.6	30/30	210	50	140	130	55	760	175	/	0.5				
XL	500	438	653	120	67.5	75	33	1221	633	479	776	ZS44/ZS56	148/110	PressFit 92	31.6	30/30	210	50	140	130	55	760	175	/	0.75				



FLAT // army green / night black / riot red

27.5" AL **HAMR** 6.7+



MODEL HIGHLIGHTS

- ▶ Boost standard offers 29" compatibility
- ▶ Metric sized Rock Shox rear shock
- ▶ Reliable Aluminum frame

MODELL HIGHLIGHTS

- ▶ Boost-Standard: 29" möglich
- ▶ Metrischer Rock Shox-Dämpfer
- ▶ Zuverlässiger Alu-Rahmen

HAMR AL	Shimano SLX FD-M7020 Side Swing	Rodi Black Jack 584x40 mm 32H // Rodi Black Jack 584x40 mm 32H	PressFit 92 mm
SR Suntour AION 35 RC DS 140 mm	Shimano SLX SL-M7000	Formula DC-711 15x110 mm	FRH60058
Rock Shox Deluxe RT Air 140 mm	Shimano SLX FC-M7000 Hollowtech II 34-24	Formula DC-1248 12x148 mm	S-M-L-XL
GHOST MTB Dia. 35 mm	Shimano SLX CS-M7000 11-42	Kind Shock LEV Integra 31.6 mm	
GHOST Low Rizer MTB 760 mm Rise 15 mm Dia. 35 mm	Tektro HD-M805 Slate 4K 4/4 Piston 203/810 mm Disc	SD6 Circuit	
Shimano SLX RD-M7000 Shadow Plus 11-S	Schwalbe Nobby Nic TrailStar 27.5x2.8 // Schwalbe Rocket Ron PaceStar 27.5x2.8	16012	

SIZE	ARTICLENUMBER	NOTES
SIZE S	18HA3001	
SIZE M	18HA3002	
SIZE L	18HA3003	
SIZE XL	18HA3004	



// ALL MOUNTAIN / TOUR

FEATURES



CHARACTERISTICS

- ▶ 29" allrounders for a wide range of use
- ▶ Designed for the best possible balance between lightweight construction and durability
- ▶ Lively, agile riding characteristics for quick turns in terrain
- ▶ Moves forward with efficient momentum making every outing an experience

CHARAKTERISTIK

- ▶ 29"-Allrounder für einen breiten Einsatzbereich
- ▶ Ausgelegt auf das beste Verhältnis aus Leichtbau und Dauerhaltbarkeit
- ▶ Lebendig-wendiges Fahrverhalten für schnelle Richtungswechsel im Gelände
- ▶ Geht schwungvoll effizient nach vorne, womit jede Ausfahrt zum Erlebnis wird

TARGET GROUP

- ▶ Mountainbikers loving long and fast bike tours

ZIELGRUPPE

- ▶ Tourenfahrer, die schnelle, lange Ausfahrten lieben



// GEOMETRY AND DATA CHARTS / GEOMETRIE UND TECHNISCHE DATEN

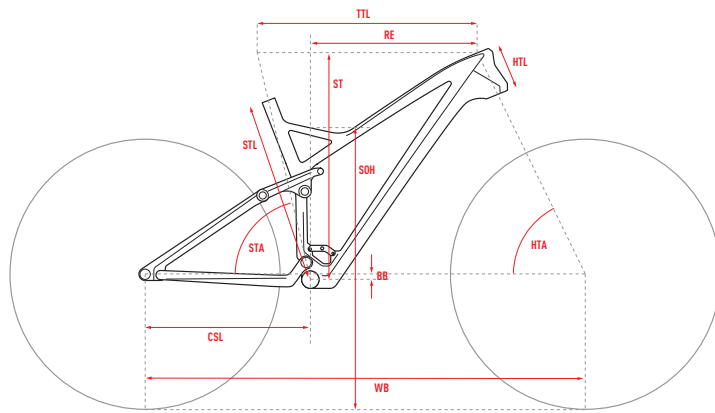

ALL DIMENSIONS IN MM (EXCEPT HTA AND STA IN °)

ALLE MASSE IN MM (AUSNAHME HTA UND STA IN °)

- STL** SEAT TUBE LENGTH
SITZROHRLÄNGE
- CSL** CHAINSTAY LENGTH
KETTENSTREBENLÄNGE
- TTL** TOP TUBE LENGTH
OBERROHRLÄNGE
- HTL** HEADTUBE LENGTH
STEUERROHRLÄNGE
- HTA** HEADTUBE ANGLE
STEUERROHRWINKEL
- STA** SEATTUBE ANGLE
SITZROHRWINKEL
- BB** BB DROP
TRETLAGERABSENKUNG
- WB** WHEELBASE
RADSTAND
- ST** STACK
STACK
- RE** REACH
REACH
- SOH** STANDOVER HEIGHT
ÜBERSTANDSHÖHE
- HEAD SET DIAMETER (UPPER / LOWER)**
STEUERSATZDURCHMESSER (OBEN / UNTEN)
- AXLE STANDARD (REAR / FRONT)**
ACHSENSTANDARD (HINTEN / VORNE)
- BOTTOM BRACKET STANDARD**
TRETLAGERSTANDARD
- SEAT POST DIAMETER**
SITZSTÜTZENDURCHMESSER
- SHOCK HARDWARE (Ø 8MM)**
DÄMPFERBUCHSENMASSE (Ø 8MM)
- SHOCK LENGTH**
DÄMPFEREINBAULÄNGE
- SHOCK TRAVEL**
DÄMPFERHUB
- FRONT FORK TRAVEL**
FEDERWEG VORNE
- REAR WHEEL TRAVEL**
FEDERWEG HINTEN
- MIN SADDLE HEIGHT**
MIN SÄTTELHÖHE
- MAX SADDLE HEIGHT**
MAX SÄTTELHÖHE
- MIN INSEAM**
MIN SCHRITTLÄNGE
- MAX INSEAM**
MAX SCHRITTLÄNGE
- STEM LENGTH**
VORBAULÄNGE
- HANDLEBAR WIDTH**
LENKERBREITE
- CRANK LENGTH**
KURBELLÄNGE
- SEATTUBE BOTTLE MOUNT**
FLASCHE SÄTTELROHR
- DOWNTUBE BOTTLE MOUNT**
FLASCHE UNTERROHR

STL CSL TTL HTL HTA STA BB WB ST RE SOH ST DT

SLAMR 9.9 LC U

	S	M	L	XL
STL	420	460	480	500
CSL	438	438	438	438
TTL	565	590	615	648
HTL	100	105	110	120
HTA	68	68	68	68
STA	75.5	75.5	75.5	75.5
BB	38	38	38	38
WB	1131	1157	1183	1216
ST	610	614	619	628
RE	407	431	455	485
SOH	730	735	757	775
Head Set Diameter	ZS44/ZS56	ZS44/ZS56	ZS44/ZS56	ZS44/ZS56
Axle Standard	148/110	148/110	148/110	148/110
Bottom Bracket Standard	PressFit 92	PressFit 92	PressFit 92	PressFit 92
Seat Post Diameter	31.6	31.6	31.6	31.6
Shock Hardware	30/30	30/30	30/30	30/30
Shock Length	210	210	210	210
Shock Travel	50	50	50	50
Front Fork Travel	130	130	130	130
Rear Wheel Travel	130	130	130	130
Min Saddle Height	50	50	50	50
Max Saddle Height	780	780	780	780
Min Inseam	175	175	175	175
Max Inseam	/	/	/	/
Stem Length	0.5	0.5	0.5	0.5
Handlebar Width				
Crank Length				
Seat Tube Bottle Mount				
Down Tube Bottle Mount				

SLAMR 6.9 LC U

	S	M	L	XL
STL	420	460	480	500
CSL	438	438	438	438
TTL	565	590	615	648
HTL	100	105	110	120
HTA	68	68	68	68
STA	75.5	75.5	75.5	75.5
BB	38	38	38	38
WB	1131	1157	1183	1216
ST	610	614	619	628
RE	407	431	455	485
SOH	730	735	757	775
Head Set Diameter	ZS44/ZS56	ZS44/ZS56	ZS44/ZS56	ZS44/ZS56
Axle Standard	148/110	148/110	148/110	148/110
Bottom Bracket Standard	PressFit 92	PressFit 92	PressFit 92	PressFit 92
Seat Post Diameter	31.6	31.6	31.6	31.6
Shock Hardware	30/30	30/30	30/30	30/30
Shock Length	210	210	210	210
Shock Travel	50	50	50	50
Front Fork Travel	130	130	130	130
Rear Wheel Travel	130	130	130	130
Min Saddle Height	60	60	60	60
Max Saddle Height	780	780	780	780
Min Inseam	175	175	175	175
Max Inseam	/	/	/	/
Stem Length	0.5	0.5	0.5	0.5
Handlebar Width				
Crank Length				
Seat Tube Bottle Mount				
Down Tube Bottle Mount				

SLAMR 4.9 AL U

	S	M	L	XL
STL	420	460	480	500
CSL	438	438	438	438
TTL	565	590	615	647
HTL	100	105	110	120
HTA	66.5	66.5	66.5	66.5
STA	75.5	75.5	75.5	75.5
BB	38	38	38	38
WB	1148	1174	1200	1234
ST	602	607	611	620
RE	409	433	457	487
SOH	743	754	756	788
Head Set Diameter	ZS44/ZS56	ZS44/ZS56	ZS44/ZS56	ZS44/ZS56
Axle Standard	148/110	148/110	148/110	148/110
Bottom Bracket Standard	PressFit 92	PressFit 92	PressFit 92	PressFit 92
Seat Post Diameter	31.6	31.6	31.6	31.6
Shock Hardware	30/30	30/30	30/30	30/30
Shock Length	210	210	210	210
Shock Travel	50	50	50	50
Front Fork Travel	130	130	130	130
Rear Wheel Travel	130	130	130	130
Min Saddle Height	60	60	60	60
Max Saddle Height	780	780	780	780
Min Inseam	175	175	175	175
Max Inseam	/	/	/	/
Stem Length	0.5	0.5	0.5	0.5
Handlebar Width				
Crank Length				
Seat Tube Bottle Mount				
Down Tube Bottle Mount				



MODEL HIGHLIGHTS

- ▶ New designed rear triangle and rocker link for added stiffness
- ▶ SRAM 1x12 X01 Eagle drivetrain
- ▶ Metric sized Rock Shox Deluxe RCT3 air shock

MODELL HIGHLIGHTS

- ▶ Neuer Hinterbau und Dämpferwippe für noch mehr Steifigkeit
- ▶ SRAM 1x12 X01 Eagle Antrieb
- ▶ Rock Shox Deluxe RCT3 metrischer Luftdämpfer

SLAMR LC	SRAM X01 Eagle 12-S	Magura MT Fifty4 4/2 Piston 180 mm Disc	16012
Rock Shox Pike RCT3 Debon Air 130 mm	-	Maxxis Minion DHR II 3C MaxxTerra Exo 29x2.3 // Maxxis Minion SS Exo 29x2.3	PressFit 92 mm
Rock Shox Deluxe RT3 Air 130 mm	SRAM GX Eagle	Syntace M 28mm Wheelset 15x110 mm // Syntace M 28mm Wheelset 12x148 mm SRAM XD	FRH60057
Syntace Megaforce2 Dia. 31.8 mm	Truvativ Descendant Carbon Eagle X-Sync 32T	Kind Shock LEV Integra 31.6 mm	S-M-L-XL
Syntace Vector 780 mm Rise 20 mm Dia. 31.8 mm	SRAM XG 1275 10-50	SD6 Fly Mountain	

SIZE	ARTICLENUMBER	NOTES
SIZE S	18SL1007	
SIZE M	18SL1008	
SIZE L	18SL1009	
SIZE XL	18SL1010	



MODEL HIGHLIGHTS

- ▶ New designed rear triangle and rocker link for added stiffness
- ▶ SRAM 1x12 GX Eagle drivetrain
- ▶ Equipped with dropper post

MODELL HIGHLIGHTS

- ▶ Neuer Hinterbau und Dämpferwippe für noch mehr Steifigkeit
- ▶ SRAM 1x12 GX Eagle Antrieb
- ▶ Versenkbare Variostütze

SLAMR LC	-	WTB XC i25 622x25 mm 32H // WTB XC i25 622x25 mm 32H	PressFit 92 mm
Rock Shox Revelation RC Debon Air 130 mm	SRAM GX Eagle	Formula DC-711 15x110 mm	FRHG0057
Rock Shox Deluxe RT Air 130 mm	Truvativ Descendant 6K Eagle X-Sync 32T	Formula DC-1248 12x148 mm	S-M-L-XL
Ground Fiftyone Dia. 31.8 mm	SRAM XG 1275 10-50	JD Dropper Post 31.6 mm	
Ground Fiftyone Race 780 mm Rise 15 mm Dia. 31.8 mm	Magura MT Thirty2 4/2 Piston 180 mm Disc	SDG Fly Mountain	
SRAM GX Eagle 12-S	Continental Mountain King II PureGrip 29x2.2 // Continental X-King Perf. PureGrip 29x2.2	16012	

SIZE	ARTICLENUMBER	NOTES
SIZE S	18SL1001	
SIZE M	18SL1002	
SIZE L	18SL1003	
SIZE XL	18SL1004	



FLAT // titanium gray / iridium silver / palladium silver

29 AL **SLAMR** 4.9



MODEL HIGHLIGHTS

- ▶ New designed rear triangle and rocker link for added stiffness
- ▶ Suntour AION 35 with big stanchions for even more stiffness
- ▶ Metric sized Rock Shox air shock

MODELL HIGHLIGHTS

- ▶ Neuer Hinterbau und Dämpferwippe für noch mehr Steifigkeit
- ▶ Suntour AION 35 mit breiten Standrohren für mehr Steifigkeit
- ▶ Metrischer Luftdämpfer von Rock Shox

SLAMR AL	Shimano XT FD-M8020 Side Swing	Rodi Tryp 622x25 mm 32H // Rodi Tryp 622x25 mm 32H	PressFit 92 mm
SR Suntour AION 35 RC DS 130 mm	Shimano XT SL-M8000	Formula DC-711 15x110 mm	FRH0058
Rock Shox Deluxe RT Air 130 mm	Shimano XT FC-M8000 Hollowtech II 36-26	Formula DC-1248 12x148 mm	S-M-L-XL
Ground Fiftyone Dia. 31.8 mm	Shimano SLX CS-M7000 11-42	JD Dropper Post 31.6 mm	
Ground Fiftyone Race 780 mm Rise 15 mm Dia. 31.8 mm	Shimano XT BR-M8000 2/2 Piston 180 mm Disc	SD6 Fly Mountain	
Shimano XT RD-M8000 Shadow Plus 11-S	Continental Mountain King II PureGrip 29x2.2 // Continental X-King Perf. PureGrip 29x2.2	16012	

SIZE	ARTICLENUMBER	NOTES
SIZE S	18SL3001	
SIZE M	18SL3002	
SIZE L	18SL3003	
SIZE XL	18SL3004	



+ LIGHTWEIGHT AND BEAUTIFULLY DESIGNED CARBON MAIN FRAME // LEICHTER UND FORMSCHÖNER CARBON-HAUPTRAHMEN

+ DROPPER SEATPOSTS WITH HANDLEBAR REMOTE - FOR FULL CONTROL FROM THE COCKPIT // VARIOSTÜTZE MIT LENKER-REMOTE FÜR VOLLE KONTROLLE VOM COCKPIT AUS

+ SENSATIONAL VALUE FOR MONEY // SENSATIONELLES PREIS-LEISTUNGS-VERHÄLTNIS

+ TRUSTED 2X10 DRIVETRAIN // BEWÄHRTER 2X10-ANTRIEB

// ALL MOUNTAIN / COMFORT

FEATURES



CHARACTERISTICS

- ▶ Tour oriented all mountain full suspension that offers a lot of comfort
- ▶ Athletic all-rounder at an attractive pricepoint
- ▶ Latest equipment in combination with a lightweight carbon frame

CHARAKTERISTIK

- ▶ Touren-orientiertes All Mountain Fully, das viel Komfort bietet
- ▶ Sportlicher Alleskönner zum attraktiven Preis
- ▶ Moderne Ausstattung in Kombination mit einem leichten Carbonrahmen

TARGET GROUP

- ▶ For those who don't care for any restrictions and are looking for an all-rounder at the fairest possible price

ZIELGRUPPE

- ▶ Für alle, die sich nicht einschränken möchten und den besten Alleskönner zum fairsten Preis suchen



// GEOMETRY AND DATA CHARTS / GEOMETRIE UND TECHNISCHE DATEN

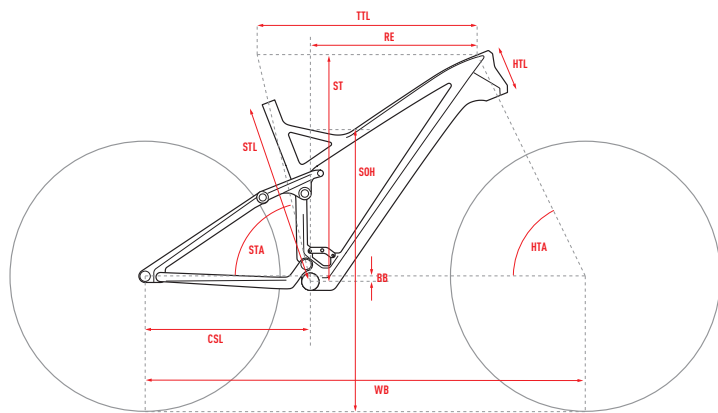













ALL DIMENSIONS IN MM (EXCEPT HTA AND STA IN °)

ALLE MASSE IN MM (AUSNAHME HTA UND STA IN °)

- STL** SEAT TUBE LENGTH
SITZROHRLÄNGE
- CSL** CHAINSTAY LENGTH
KETTENSTREBENLÄNGE
- TTL** TOP TUBE LENGTH
OBERROHRLÄNGE
- HTL** HEADTUBE LENGTH
STEUERROHRLÄNGE
- HTA** HEADTUBE ANGLE
STEUERROHRWINKEL
- STA** SEATTUBE ANGLE
SITZROHRWINKEL
- BB** BB DROP
TRETLAGERABSSENKUNG
- WB** WHEELBASE
RADSTAND
- ST** STACK
STACK
- RE** REACH
REACH
- SOH** STANDOVER HEIGHT
ÜBERSTANDSHÖHE
-  **HEAD SET DIAMETER (UPPER / LOWER)**
STEUERSATZDURCHMESSER (OBEN / UNTEN)
-  **AXLE STANDARD (REAR / FRONT)**
ACHSENSTANDARD (HINTEN / VORNE)
-  **BOTTOM BRACKET STANDARD**
TRETLAGERSTANDARD
-  **SEAT POST DIAMETER**
SITZELSTÜTZENDURCHMESSER
-  **SHOCK HARDWARE (Ø 8MM)**
DÄMPFERBUCHSENMASSE (Ø 8MM)
-  **SHOCK LENGTH**
DÄMPFEREINBAULÄNGE
-  **SHOCK TRAVEL**
DÄMPFERHUB
-  **FRONT FORK TRAVEL**
FEDERWEG VORNE
-  **REAR WHEEL TRAVEL**
FEDERWEG HINTEN
-  **MIN SADDLE HEIGHT**
MIN SITZELHÖHE
-  **MAX SADDLE HEIGHT**
MAX SITZELHÖHE
-  **MIN INSEAM**
MIN SCHRITTLÄNGE
-  **MAX INSEAM**
MAX SCHRITTLÄNGE
-  **STEM LENGTH**
VORBAULÄNGE
-  **HANDLEBAR WIDTH**
LENKERBREITE
-  **CRANK LENGTH**
KURBELLÄNGE
-  **SEATTUBE BOTTLE MOUNT**
FLASCHE SATTELROHR
-  **DOWNTUBE BOTTLE MOUNT**
FLASCHE UNTERROHR

STL CSL TTL HTL HTA STA BB WB ST RE SOH             

SLAMR 3.7 LC U

	STL	CSL	TTL	HTL	HTA	STA	BB	WB	ST	RE	SOH																		
S	440	430	576	110	68	74.5	16	1126	585	416	725	ZS44/ZS56	142/110	PressFit 92	31.6	30/22.2	200	51	130	130	60	780	175	/	0.5				
M	470	430	602	120	68	74.5	16	1152	594	438	740	ZS44/ZS56	142/110	PressFit 92	31.6	30/22.2	200	51	130	130	60	780	175	/	0.5				
L	500	430	628	130	68	74.5	16	1178	604	461	775	ZS44/ZS56	142/110	PressFit 92	31.6	30/22.2	200	51	130	130	60	780	175	/	0.75				
XL	540	430	644	140	68	74.5	16	1193	611	476	805	ZS44/ZS56	142/110	PressFit 92	31.6	30/22.2	200	51	130	130	60	780	175	/	0.75				



MODEL HIGHLIGHTS

- ▶ Popular SLAMR LC frame
- ▶ Comfortable geometry for great mountain biking experiences
- ▶ Tailored to the needs of touring bikers with dropper post and 2x10 drivetrain

MODELL HIGHLIGHTS

- ▶ Beliebter SLAMR LC-Rahmen
- ▶ Komfortable Geometrie für angenehme Mountainbike-Erlebnisse
- ▶ Exakt für Tourenfahrer zugeschnitten mit Vario-Sattelstütze und 2x10-Antrieb

SLAMR LC	Shimano Deore FD-M6020 Side Swing	Rodi Tryp 584x25 mm 32H // Rodi Tryp 584x25 mm 32H	PressFit 92 mm
SR Suntour AION LO-R 130 mm	Shimano Deore SL-M6000	Formula DC-71 15x100 mm	FRH60058
Rock Shox Monarch RT Air 130 mm	Shimano Deore FC-M6000 Hollowtech II 34-24	Formula GHL-360 12x142 mm	S-M-L-XL
Ground Fiftyone Dia. 31.8 mm	Shimano CS-HG500-10 11-42	JD Dropper Post 31.6 mm	
Ground Fiftyone Race 780 mm Rise 15 mm Dia. 31.8 mm	Shimano BR-M365 2/2 Piston 180 mm Disc	SD6 Fly Mountain	
Shimano Deore RD-M6000 Shadow Plus 10-S	Continental Mountain King II PureGrip 27.5x2.2 // Continental X-King Perf. PureGrip 27.5x2.2	16012	

SIZE	ARTICLENUMBER	NOTES
SIZE S	18SL2001	
SIZE M	18SL2002	
SIZE L	18SL2003	
SIZE XL	18SL2004	

LECTOR X



DISCONNECT BRAKE MOUNT AND BOOST AXLE STANDARD FRONT AND BACK // DISCONNECT BRAKE MOUNT SOWIE BOOST-ACHSSTANDARD VORNE UND HINTEN

STRIKING, EDGY RIOT-SHAPE DESIGN // MARKANT KANTIGES RIOT-SHAPE-DESIGN

EXTREMELY LIGHTWEIGHT AND STIFF FRAME-FORK UNIT // EXTREM LEICHTE UND STEIFE RAHMEN-GABEL-EINHEIT

GHOST CARBON RIGID FORK WITH DISCONNECT BRAKE MOUNT // GHOST CARBON-STARRGABEL MIT DISCONNECT BRAKE MOUNT

SET-UP WITHOUT COMPROMISE FOR STRIKING EFFICIENCY // KOMPROMISSLOSES SET-UP FÜR BESTECHENDE EFFIZIENZ

// MARATHON / hardcore

FEATURES



CHARACTERISTICS

- ▶ Low-maintenance race machine with desire for altitude
- ▶ A propulsion powerhouse that rewards every sprint with the lead
- ▶ Greedy sprinter that leaves any competitor in the dust
- ▶ Race-ready competition bike - no compromise allowed

CHARAKTERISTIK

- ▶ Wartungsarme Rennfeile mit Drang nach Höhenmetern
- ▶ Eine vortriebsstarke Einheit, mit der jeder Sprint zur Spitze führt
- ▶ Gieriger Sprinter, der jeden Konkurrenten hinter sich lässt
- ▶ Rennfertiges Wettkampfbike, das keinen Kompromiss erlaubt

TARGET GROUP

- ▶ For competitors who don't delight in participation - domination of the competition is what they are after

ZIELGRUPPE

- ▶ Für Rennfahrer, die sich nicht an der Teilnahme erfreuen, sondern ihre Gegner dominieren möchten



LECTOR X

// GEOMETRY AND DATA CHARTS / GEOMETRIE UND TECHNISCHE DATEN

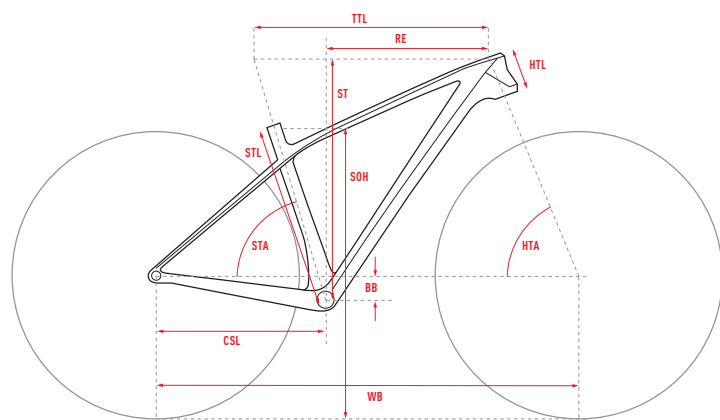

ALL DIMENSIONS IN MM (EXCEPT HTA AND STA IN °)

ALLE MASSE IN MM (AUSNAHME HTA UND STA IN °)

- STL** SEAT TUBE LENGTH
SITZROHRLÄNGE
- CSL** CHAINSTAY LENGTH
KETTENSTREBENLÄNGE
- TTL** TOP TUBE LENGTH
OBERROHRLÄNGE
- HTL** HEADTUBE LENGTH
STEUERROHRLÄNGE
- HTA** HEADTUBE ANGLE
STEUERROHRWINKEL
- STA** SEATTUBE ANGLE
SITZROHRWINKEL
- BB** BB DROP
TRETLAGERABSSENKUNG
- WB** WHEELBASE
RADSTAND
- ST** STACK
STACK
- RE** REACH
REACH
- SOH** STANDOVER HEIGHT
ÜBERSTANDSHÖHE
- HEAD SET DIAMETER (UPPER / LOWER)
STEUERSATZDURCHMESSER (OBEN / UNTEN)
- AXLE STANDARD (REAR / FRONT)
ACHSENSTANDARD (HINTEN / VORNE)
- BOTTOM BRACKET STANDARD
TRETLAGERSTANDARD
- SEAT POST DIAMETER
SITZSTÜTZENDURCHMESSER
- SHOCK HARDWARE (Ø 8MM)
DÄMPFERBUCHSENMASSE (Ø 8MM)
- SHOCK LENGTH
DÄMPFEREINBAULÄNGE
- SHOCK TRAVEL
DÄMPFERHUB
- FRONT FORK TRAVEL
FEDERWEG VORNE
- REAR WHEEL TRAVEL
FEDERWEG HINTEN
- MIN SADDLE HEIGHT
MIN SITZTELHÖHE
- MAX SADDLE HEIGHT
MAX SITZTELHÖHE
- MIN INSEAM
MIN SCHRITTLÄNGE
- MAX INSEAM
MAX SCHRITTLÄNGE
- STEM LENGTH
VORBAULÄNGE
- HANDLEBAR WIDTH
LENKERBREITE
- CRANK LENGTH
KURBELLÄNGE
- SEAT TUBE BOTTLE MOUNT
FLASCHE SATTELROHR
- DOWNTUBE BOTTLE MOUNT
FLASCHE UNTERROHR

STL CSL TTL HTL HTA STA BB WB ST RE SOH ST DT

LECTOR X 8.9 UC U

	STL	CSL	TTL	HTL	HTA	STA	BB	WB	ST	RE	SOH																		
S	420	429	592	95.5	70.8	74.3	70	1090	597	425	720	ZS44/ZS56	148/110	Pressfit92	31.6	/	/	/	/	/	/	75	740	175	0.75	0.75			
M	460	429	607	106.5	70.8	74.3	70	1106	606	437	723	ZS44/ZS56	148/110	Pressfit92	31.6	/	/	/	/	/	/	75	740	175	0.75	0.75			
L	500	429	622	115.5	70.8	74.3	70	1121	616	449	748	ZS44/ZS56	148/110	Pressfit92	31.6	/	/	/	/	/	/	75	740	175	0.75	0.75			
XL	540	429	633	125.5	70.8	74.3	70	1132	625	456	760	ZS44/ZS56	148/110	Pressfit92	31.6	/	/	/	/	/	/	75	740	175	0.75	0.75			



FLAT // night black / night black / neon yellow

29 UC **LECTOR X** 8.9



MODEL HIGHLIGHTS

- ▶ Made for hillclimbs and sprint races
- ▶ Award-winning design
- ▶ Low maintenance bike with lightweight and reliable components

MODELL HIGHLIGHTS

- ▶ Gemacht für schnelle Bergpassagen und Sprints
- ▶ Preisgekröntes Design
- ▶ Wartungsarmes Bike mit leichten und zuverlässigen Komponenten

LECTOR UC	-	Continental Race King Black Chili 29x2.2 // Continental Race King Black Chili 29x2.2	PressFit 92 mm
GHOST UC Rigid	SRAM GX Eagle	DT Swiss M 1700 Spline 25 mm Wheelset 15x110 mm // DT Swiss M 1700 Spline 25 mm Wheelset 12x148 mm SRAM XD	FRH6002
Ground Fiftyone Dia. 31.8 mm	Truativ Descendant X-Sync 32T	Ground Fiftyone Team Carbon 31.6 mm	S-M-L-XL
Ground Fiftyone Team 740 mm Dia. 31.8 mm	SRAM XG 1275 10-50	Fizik Antares R7	
SRAM X01 Eagle 12-S	SRAM Level T 2/2 Piston 180/160 mm Disc	16012	

SIZE	ARTICLENUMBER	NOTES
SIZE S	18LE2022	
SIZE M	18LE2023	
SIZE L	18LE2024	
SIZE XL	18LE2025	

LECTOR



DIVERSE COLOR OPTIONS GIVING EVERY RIDER THE OPPORTUNITY TO MAKE HIS OR HER INDIVIDUAL STATEMENT // VIELFÄLTIGE FARBOPTIONEN, MIT DENEN JEDER FAHRER SEIN INDIVIDUELLES STATEMENT SETZT



ERGONOMIC CONTACT POINTS // ERGONOMISCHE KONTAKTPUNKTE

SPECS FOR XC AND MARATHON // SPEZIFIKATIONEN FÜR XC UND MARATHON



27.5" & 29" MODELS // 27.5" - & 29" - MODELLE



SHIMANO 2X AND SRAM 1X12 EAGLE DRIVETRAINS // SHIMANO 2-FACH UND SRAM 1X12 EAGLE-ANTRIEBE

// XC / COMPETITION

FEATURES



CHARACTERISTICS

- ▶ A bike bursting with stiffness and transferring it into all-out propulsion
- ▶ Marathon and XC target characteristics through different equipment combinations
- ▶ Ergonomical components take the edge off of long, hard race stages
- ▶ Precise and fast reacting handling for quick turns on the race course

CHARAKTERISTIK

- ▶ Ein Bike, das nur so vor Steifigkeit strotzt und diese in kompromisslosen Vortrieb umsetzt
- ▶ Ausprägungen in Marathon und XC durch unterschiedliche Ausstattungskombinationen
- ▶ Ergonomische Anbauteile nehmen langen, harten Rennetappen ihren Schrecken.
- ▶ Präzises und reaktionsschnelles Handling für schnelle Richtungswechsel auf der Wettkampfstrecke

TARGET GROUP

- ▶ Pure performance for racers, marathon enthusiasts and ambitious amateurs looking for genuine unaltered GHOST-DNA



ZIELGRUPPE

- ▶ Pure Performance für Racer, Marathonisti und ambitionierte Hobbyfahrer, die nach unverfälschter GHOST-DNA suchen

LECTOR

// GEOMETRY AND DATA CHARTS / GEOMETRIE UND TECHNISCHE DATEN

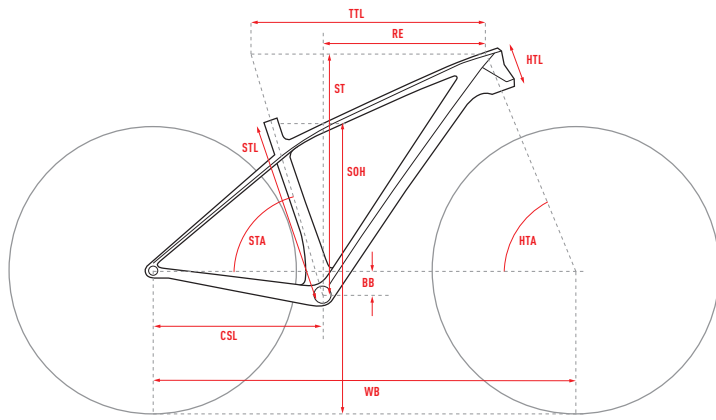

ALL DIMENSIONS IN MM (EXCEPT HTA AND STA IN °)

ALLE MASSE IN MM (AUSNAHME HTA UND STA IN °)

- STL** SEAT TUBE LENGTH
SITZROHRLÄNGE
- CSL** CHAINSTAY LENGTH
KETTENSTREBELÄNGE
- TTL** TOP TUBE LENGTH
OBERROHRLÄNGE
- HTL** HEADTUBE LENGTH
STEUERROHRLÄNGE
- HTA** HEADTUBE ANGLE
STEUERROHRWINKEL
- STA** SEATTUBE ANGLE
SITZROHRWINKEL
- BB** BB DROP
TRETLAGERABSENKUNG
- WB** WHEELBASE
RADSTAND
- ST** STACK
STACK
- RE** REACH
REACH
- SOH** STANDOVER HEIGHT
ÜBERSTANDSHÖHE
- HSD** HEAD SET DIAMETER (UPPER / LOWER)
STEUERSATZDURCHMESSER (OBEN / UNTEN)
- AS** AXLE STANDARD (REAR / FRONT)
ACHSENSTANDARD (HINTEN / VORNE)
- BS** BOTTOM BRACKET STANDARD
TRETLAGERSTANDARD
- SPD** SEAT POST DIAMETER
SITTELSTÜTZENDURCHMESSER
- SHD** SHOCK HARDWARE (Ø 8MM)
DÄMPFERBUCHSENMASSE (Ø 8MM)
- SL** SHOCK LENGTH
DÄMPFEREINBAULÄNGE
- STV** SHOCK TRAVEL
DÄMPFERHUB
- FV** FRONT FORK TRAVEL
FEDERWEG VORNE
- RV** REAR WHEEL TRAVEL
FEDERWEG HINTEN
- MSH** MIN SADDLE HEIGHT
MIN SÄTTELHÖHE
- MSH2** MAX SADDLE HEIGHT
MAX SÄTTELHÖHE
- MSL** MIN INSEAM
MIN SCHRITTLÄNGE
- MSL2** MAX INSEAM
MAX SCHRITTLÄNGE
- SL2** STEM LENGTH
VORBAULÄNGE
- HL** HANDLEBAR WIDTH
LENKERBREITE
- CL** CRANK LENGTH
KURBELLENGE
- SB** SEATTUBE BOTTLE MOUNT
FLASCHE SÄTTELROHR
- SB2** DOWNTUBE BOTTLE MOUNT
FLASCHE UNTERROHR

	STL	CSL	TTL	HTL	HTA	STA	BB	WB	ST	RE	SOH	HSD	AS	BS	SPD	SHD	SL	STV	FV	RV	MSH	MSH2	MSL	MSL2	SL2	HL	CL	SB	SB2		
LECTOR WC.9 UC U																															
S	420	430	596	95.5	69.5	73	60	1100	607	410	727	ZS44/ZS56	148/110	Pressfit92	31.6	/	/	/	100	/	75	740	175	/	0.75						
M	460	430	611	105.5	69.5	73	60	1115	616	423	734	ZS44/ZS56	148/110	Pressfit92	31.6	/	/	/	100	/	75	740	175	/	0.75						
L	500	430	626	115.5	69.5	73	60	1131	626	436	743	ZS44/ZS56	148/110	Pressfit92	31.6	/	/	/	100	/	75	740	175	/	0.75						
XL	540	430	637	125.5	69.5	73	60	1142	635	443	754	ZS44/ZS56	148/110	Pressfit92	31.6	/	/	/	100	/	75	740	175	/	0.75						
LECTOR 10.9 / 9.9 UC U																															
S	420	430	596	95.5	69.5	73	60	1100	607	410	727	ZS44/ZS56	148/110	Pressfit92	31.6	/	/	/	100	/	75	740	175	0.75	0.75						
M	460	430	611	105.5	69.5	73	60	1115	616	423	734	ZS44/ZS56	148/110	Pressfit92	31.6	/	/	/	100	/	75	740	175	0.75	0.75						
L	500	430	626	115.5	69.5	73	60	1131	626	436	743	ZS44/ZS56	148/110	Pressfit92	31.6	/	/	/	100	/	75	740	175	0.75	0.75						
XL	540	430	637	125.5	69.5	73	60	1142	635	443	754	ZS44/ZS56	148/110	Pressfit92	31.6	/	/	/	100	/	75	740	175	0.75	0.75						
LECTOR WCR.9 / 8.9 / 7.9 LC U																															
S	420	430	596	95.5	69.5	73	60	1100	607	410	727	ZS44/ZS56	142/110	Pressfit92	31.6	/	/	/	100	/	75	740	175	0.75	0.75						
M	460	430	611	105.5	69.5	73	60	1115	616	423	734	ZS44/ZS56	142/110	Pressfit92	31.6	/	/	/	100	/	75	740	175	0.75	0.75						
L	500	430	626	115.5	69.5	73	60	1131	626	436	743	ZS44/ZS56	142/110	Pressfit92	31.6	/	/	/	100	/	75	740	175	0.75	0.75						
XL	540	430	637	125.5	69.5	73	60	1142	635	443	754	ZS44/ZS56	142/110	Pressfit92	31.6	/	/	/	100	/	75	740	175	0.75	0.75						
LECTOR 6.9 / 5.9 / 4.9 / 3.9 LC U																															
XS	380	430	581	95.5	69.5	73	60	1048	607	395	699	ZS44/ZS56	142/110	Pressfit92	31.6	/	/	/	100	/	75	740	175	0.5	0.75						
S	420	430	596	95.5	69.5	73	60	1100	607	410	727	ZS44/ZS56	142/110	Pressfit92	31.6	/	/	/	100	/	75	740	175	0.75	0.75						
M	460	430	611	105.5	69.5	73	60	1115	616	423	734	ZS44/ZS56	142/110	Pressfit92	31.6	/	/	/	100	/	75	740	175	0.75	0.75						
L	500	430	626	115.5	69.5	73	60	1131	626	436	743	ZS44/ZS56	142/110	Pressfit92	31.6	/	/	/	100	/	75	740	175	0.75	0.75						
XL	540	430	637	125.5	69.5	73	60	1142	635	443	754	ZS44/ZS56	142/110	Pressfit92	31.6	/	/	/	100	/	75	740	175	0.75	0.75						
LECTOR 3.7 LC U																															
XS	380	422	552	105.5	69	74	48	1058	580	387	680	ZS44/ZS56	142/110	Pressfit92	31.6	/	/	/	100	/	75	740	175	0.5	0.75						
S	410	422	572	110.5	69	74	48	1079	589	404	713	ZS44/ZS56	142/110	Pressfit92	31.6	/	/	/	100	/	75	740	175	0.75	0.75						
M	450	422	592	110.5	69	74	48	1099	588	424	723	ZS44/ZS56	142/110	Pressfit92	31.6	/	/	/	100	/	75	740	175	0.75	0.75						
L	490	422	618	120.5	69	74	48	1126	598	448	758	ZS44/ZS56	142/110	Pressfit92	31.6	/	/	/	100	/	75	740	175	0.75	0.75						
LECTOR 2.9 LC U																															
XS	380	430	581	95.5	69.5	73	60	1048	607	395	699	ZS44/ZS56	142/100	Pressfit92	31.6	/	/	/	100	/	75	740	175	0.5	0.75						
S	420	430	596	95.5	69.5	73	60	1100	607	410	727	ZS44/ZS56	142/100	Pressfit92	31.6	/	/	/	100	/	75	740	175	0.75	0.75						
M	460	430	611	105.5	69.5	73	60	1115	616	423	734	ZS44/ZS56	142/100	Pressfit92	31.6	/	/	/	100	/	75	740	175	0.75	0.75						
L	500	430	626	115.5	69.5	73	60	1131	626	436	743	ZS44/ZS56	142/100	Pressfit92	31.6	/	/	/	100	/	75	740	175	0.75	0.75						
XL	540	430	637	125.5	69.5	73	60	1142	635	443	754	ZS44/ZS56	142/100	Pressfit92	31.6	/	/	/	100	/	75	740	175	0.75	0.75						
LECTOR 2.7 LC U																															
XS	380	422	552	105.5	69	74	48	1058	580	387	680	ZS44/ZS56	142/100	Pressfit92	31.6	/	/	/	100	/	75	740	175	0.5	0.75						
S	410	422	572	110.5	69	74	48	1079	589	404	713	ZS44/ZS56	142/100	Pressfit92	31.6	/	/	/	100	/	75	740	175	0.75	0.75						
M	450	422	592	110.5	69	74	48	1099	588	424	723	ZS44/ZS56	142/100	Pressfit92	31.6	/	/	/	100	/	75	740	175	0.75	0.75						
L	490	422	618	120.5	69	74	48	1126	598	448	758	ZS44/ZS56	142/100	Pressfit92	31.6	/	/	/	100	/	75	740	175	0.75	0.75						



MODEL HIGHLIGHTS

- ▶ Our GHOST Factory Racing Team's World Cup bike
- ▶ Lightweight and comfortable Bike Ahead seat post, made in Germany
- ▶ 1x12 SRAM Eagle drivetrain with 500 % bandwidth

MODELL HIGHLIGHTS

- ▶ Das Worldcup-Bike unseres GHOST Factory-Rennteam's
- ▶ Leichte und komfortable Sattelstütze von Bike Ahead, made in Germany
- ▶ 1x12 SRAM Eagle Antrieb mit 500 % Bandbreite

LECTOR UC	-	Schwalbe Thunder Burt Addix SpeedGrip 29x2.25 // Schwalbe Thunder Burt Addix SpeedGrip 29x2.25	PressFit 92 mm
Rock Shox SID World Cup Solo Air Oneloc 100 mm	SRAM XX1 Eagle	Tune Skyline Black Burner 29 XC Wheelset 15x110 mm // Tune Skyline Black Burner 29 XC Wheelset 12x148 mm SRAM XD	FRH6002
Syntace Force 109 T1 Dia. 31.8 mm	SRAM XX1 Eagle X-Sync 34T	Bike Ahead THE Seatpost 31.6 mm	S-M-L-XL
Bike Ahead THE Flatbar 740 mm Dia. 31.8 mm	SRAM XG 1299 10-50	Fizik Antares 00	
SRAM XX1 Eagle 12-S	SRAM Level Ultimate 2/2 Piston 180/160 mm Disc	16012	

SIZE	ARTICLENUMBER	NOTES
SIZE S	18LE5002	
SIZE M	18LE5003	
SIZE L	18LE5004	
SIZE XL	18LE5005	



MODEL HIGHLIGHTS

- ▶ FOX 32 Float Factory fork with Step-Cast
- ▶ Shimano XTR 2x11 drivetrain
- ▶ High-end lightweight DT Swiss XRC Carbon 1200 Spline wheelset

MODELL HIGHLIGHTS

- ▶ FOX 32 Float Factory Gabel mit Step-Cast
- ▶ Shimano XTR 2x11-Antrieb
- ▶ Hochwertige und leichte DT Swiss XRC Carbon 1200 Spline Räder

LECTOR UC	Shimano XTR FD-M9020 Side Swing	Schwalbe Rocket Ron Addix SpeedGrip 29x2.25 // Schwalbe Thunder Burt Addix SpeedGrip 29x2.25	PressFit 92 mm
Fox 32 Float Factory Step Cast Remote 100 mm	Shimano XTR SL-M9000	DT Swiss XRC 1200 Spline 25 mm Wheelset 15x110 mm // DT Swiss XRC 1200 Spline 25 mm Wheelset 12x148 mm	FRHG0001
Syntace Force 109 Dia. 31.8 mm	Shimano XTR Trail FC-M9020 36-26	Syntace P6 Carbon 31.6 mm	S-M-L-XL
Ground Fiftyone Pro Team Carbon 740 mm Dia. 31.8 mm	Shimano XT CS-M8000 11-46	Fizik Antares R7	
Shimano XTR RD-M9000 11-S	Shimano XTR Race BR-M9000 2/2 Piston 180 / 160 mm Disc	16012	

SIZE	ARTICLENUMBER	NOTES
SIZE S	18LE2009	
SIZE M	18LE2010	
SIZE L	18LE2011	
SIZE XL	18LE2012	



MODEL HIGHLIGHTS

- ▶ 1x12 SRAM Eagle drivetrain with 500 % bandwidth
- ▶ Lightweight components: Rock Shox SID RL, DT Swiss XR1501
- ▶ Carbon crankset

MODELL HIGHLIGHTS

- ▶ 1x12 SRAM Eagle Antrieb mit 500 % Bandbreite
- ▶ Leichte Anbauteile: Rock Shox SID RL, DT Swiss XR1501
- ▶ Carbon-Kurbeln

LECTOR UC	-	Schwalbe Rocket Ron Addix SpeedGrip 29x2.25 // Schwalbe Thunder Burt Addix SpeedGrip 29x2.25	PressFit 92 mm
Rock Shox SID RL Solo Air OneLoc 100 mm	SRAM X01 Eagle	DT Swiss XR 1501 Spline 25 mm Wheelset 15x110 mm // DT Swiss XR 1501 Spline 25 mm Wheelset 12x148 mm SRAM XD	FRH6002
Syntace Force 109 Dia. 31.8 mm	Truvativ Descendant Carbon Eagle X-Sync 32T	Syntace P6 Carbon 31.6 mm	S-M-L-XL
Syntace Vector Carbon 740 mm Rise 5 mm Dia. 31.8 mm	SRAM XG 1295 10-50	Fizik Antares R7	
SRAM X01 Eagle 12-S	SRAM Level TL 2/2 Piston 180/160 mm Disc	16012	

SIZE	ARTICLENUMBER	NOTES
SIZE S	18LE2002	
SIZE M	18LE2003	
SIZE L	18LE2004	
SIZE XL	18LE2005	





















MODEL HIGHLIGHTS

- ▶ World Cup replica
- ▶ DT Swiss M 1700 Spline wheelset
- ▶ 1x12 SRAM Eagle drivetrain with 500 % bandwidth

MODELL HIGHLIGHTS

- ▶ Replika des Worldcup-Bikes
- ▶ DT Swiss M 1700 Spline Laufradsatz
- ▶ 1x12 SRAM Eagle Antrieb mit 500 % Bandbreite

 LECTOR LC	 -	 Schwalbe Rocket Ron Addix SpeedGrip 29x2.25 // Schwalbe Thunder Burt Addix SpeedGrip 29x2.25	 PressFit 92 mm
 Rock Shox SID RL Solo Air OneLoc 100 mm	 SRAM X01 Eagle	 DT Swiss M 1700 Spline 25 mm Wheelset 15x110 mm // DT Swiss M 1700 Spline 25 mm Wheelset 12x142 mm SRAM XD	 FRHG0002
 Ground Fiftyone Dia. 31.8 mm	 Truvativ Descendant Carbon Eagle X-Sync 32T	 Rock Shox Reverb Stealth 31.6 mm	 S-M-L-XL
 Ground Fiftyone Pro Team Carbon 740 mm Dia. 31.8 mm	 SRAM XG 1275 10-50	 Fizik Antares R7	
 SRAM X01 Eagle 12-S	 SRAM Level TL 2/2 Piston 180/160 mm Disc	 16012	

SIZE	ARTICLENUMBER	NOTES
SIZE S	18LE1093	
SIZE M	18LE1094	
SIZE L	18LE1095	
SIZE XL	18LE1096	



FLAT // smoke gray / night black / neon yellow

29 LC **LECTOR** 8.9



MODEL HIGHLIGHTS

- ▶ Shimano 2x11 XT Di2 drivetrain
- ▶ High-end components
- ▶ Color option available

MODELL HIGHLIGHTS

- ▶ Shimano 2x11 XT Di2-Antrieb
- ▶ Hochwertige Anbauteile
- ▶ Mit Farboption

LECTOR LC	Shimano XT Di2 FD-M8070	Continental X-King Perf. PureGrip 29x2.2 // Continental X-King Perf. PureGrip 29x2.2	PressFit 92 mm
Fox 32 Float Performance Remote 100 mm	Shimano XT Di2 SW-M8050	DT Swiss M 1700 Spline 25 mm Wheelset 15x110 mm // DT Swiss M 1700 Spline 25 mm Wheelset 12x142 mm	FRH6001
Ground Fiftyone Dia. 31.8 mm	Shimano XT FC-M8000 Hollowtech II 36-26	Ground Fiftyone Team Carbon 31.6 mm	S-M-L-XL
Ground Fiftyone 740 mm Dia. 31.8 mm	Shimano XT CS-M8000 11-42	Fizik Antares R7	
Shimano XT Di2 RD-M8050 Shadow Plus 11-S	Shimano XT BR-M8000 2/2 Piston 180/160 mm Disc	16012	

SIZE	ARTICLENUMBER	NOTES
SIZE S	18LE1086	
SIZE M	18LE1087	
SIZE L	18LE1088	
SIZE XL	18LE1089	



MODEL HIGHLIGHTS

- ▶ Shimano 2x11 XT Di2 drivetrain
- ▶ High-end components
- ▶ Color option available

MODELL HIGHLIGHTS

- ▶ Shimano 2x11 XT Di2-Antrieb
- ▶ Hochwertige Anbauteile
- ▶ Mit Farboption

LECTOR LC	Shimano XT Di2 FD-M8070	Continental X-King Perf. PureGrip 29x2.2 // Continental X-King Perf. PureGrip 29x2.2	PressFit 92 mm
Fox 32 Float Performance Remote 100 mm	Shimano XT Di2 SW-M8050	DT Swiss M 1700 Spline 25 mm Wheelset 15x110 mm // DT Swiss M 1700 Spline 25 mm Wheelset 12x142 mm	FRHG001
Ground Fiftyone Dia. 31.8 mm	Shimano XT FC-M8000 Hollowtech II 36-26	Ground Fiftyone Team Carbon 31.6 mm	S-M-L-XL
Ground Fiftyone 740 mm Dia. 31.8 mm	Shimano XT CS-M8000 11-42	Fizik Antares R7	
Shimano XT Di2 RD-M8050 Shadow Plus 11-S	Shimano XT BR-M8000 2/2 Piston 180/160 mm Disc	16012	

SIZE	ARTICLENUMBER	NOTES
SIZE S	18LE1079	
SIZE M	18LE1080	
SIZE L	18LE1081	
SIZE XL	18LE1082	



SHINY // spectra yellow / night black / titanium gray

29 LC **LECTOR** 7.9



MODEL HIGHLIGHTS

- ▶ Desirable Rock Shox RS1 upside-down fork
- ▶ 1x12 SRAM Eagle drivetrain with 500 % bandwidth
- ▶ Comfortable long distance marathon bike

MODELL HIGHLIGHTS

- ▶ Begehrte Rock Shox RS1 Upsidedown-Gabel
- ▶ 1x12 SRAM Eagle Antrieb mit 500 % Bandbreite
- ▶ Komfortables Langstrecken-Marathon-Bike

LECTOR LC	-	Continental X-King Perf. PureGrip 29x2.2 // Continental X-King Perf. PureGrip 29x2.2	Fizik Antares R7
Rock Shox RS1 Oneloc 100 mm	SRAM GX Eagle	Rodi Tryp 622x25 mm 32H // Rodi Tryp 622x25 mm 32H	16012
Ground Fiftyone Dia. 31.8 mm	Truvativ Descendant X-Sync 32T	SRAM PS Front Hub 15x110 mm	PressFit 92 mm
Ground Fiftyone 740 mm Dia. 31.8 mm	SRAM XG 1275 10-50	Formula DHT-142 12x142 mm SRAM XD	FRH60002
SRAM GX Eagle 12-S	SRAM Level T 2/2 Piston 180/160 mm Disc	Ground Fiftyone 31.6 mm	S-M-L-XL

SIZE	ARTICLENUMBER	NOTES
SIZE S	18LE1072	
SIZE M	18LE1073	
SIZE L	18LE1074	
SIZE XL	18LE1075	



MODEL HIGHLIGHTS

- ▶ Stiff and lightweight DT Swiss M 1700 Spline wheelset
- ▶ Shimano 2x11 XT drivetrain
- ▶ Lightweight FOX Step-Cast fork with remote lockout

MODELL HIGHLIGHTS

- ▶ Steifer und leichter DT Swiss M 1700 Spline Laufradsatz
- ▶ Shimano 2x11 XT-Antrieb
- ▶ Leichte FOX Step-Cast Gabel mit Remote Lockout

LECTOR LC	Shimano XT FD-M8020 Side Swing	Continental X-King Perf. PureGrip 29x2.2 // Continental X-King Perf. PureGrip 29x2.2	PressFit 92 mm
Fox 32 Float Performance Remote 100 mm	Shimano XT SL-M8000	DT Swiss M 1700 Spline 25 mm Wheelset 15x110 mm // DT Swiss M 1700 Spline 25 mm Wheelset 12x142 mm	FRHG001
Ground Fiftyone Dia. 31.8 mm	Shimano XT FC-M8000 Hollowtech II 36-26	Ground Fiftyone Team Carbon 31.6 mm	XS-S-M-L-XL
Ground Fiftyone 740 mm Dia. 31.8 mm	Shimano SLX CS-M7000 11-42	Fizik Antares R7	
Shimano XT RD-M8000 Shadow Plus 11-S	Shimano XT BR-M8000 2/2 Piston 180/160 mm Disc	16012	

SIZE	ARTICLENUMBER	NOTES
SIZE XS	18LE1057	
SIZE S	18LE1058	
SIZE M	18LE1059	
SIZE L	18LE1060	
SIZE XL	18LE1061	



MODEL HIGHLIGHTS

- ▶ Stiff and lightweight DT Swiss M 1700 Spline wheelset
- ▶ Shimano 2x11 XT drivetrain
- ▶ Lightweight FOX Step-Cast fork with remote lockout

MODELL HIGHLIGHTS

- ▶ Steifer und leichter DT Swiss M 1700 Spline Laufradsatz
- ▶ Shimano 2x11 XT-Antrieb
- ▶ Leichte FOX Step-Cast Gabel mit Remote Lockout

LECTOR LC	Shimano XT FD-M8020 Side Swing	Continental X-King Perf. PureGrip 29x2.2 // Continental X-King Perf. PureGrip 29x2.2	PressFit 92 mm
Fox 32 Float Performance Remote 100 mm	Shimano XT SL-M8000	DT Swiss M 1700 Spline 25 mm Wheelset 15x110 mm // DT Swiss M 1700 Spline 25 mm Wheelset 12x142 mm	FRH60001
Ground Fiftyone Dia. 31.8 mm	Shimano XT FC-M8000 Hollowtech II 36-26	Ground Fiftyone Team Carbon 31.6 mm	XS-S-M-L-XL
Ground Fiftyone 740 mm Dia. 31.8 mm	Shimano SLX CS-M7000 11-42	Fizik Antares R7	
Shimano XT RD-M8000 Shadow Plus 11-S	Shimano XT BR-M8000 2/2 Piston 180/160 mm Disc	16012	

SIZE	ARTICLENUMBER	NOTES
SIZE XS	18LE1064	
SIZE S	18LE1065	
SIZE M	18LE1066	
SIZE L	18LE1067	
SIZE XL	18LE1068	



MODEL HIGHLIGHTS

- ▶ Lightweight Rock Shox Reba fork
- ▶ 1x12 SRAM Eagle drivetrain with 500 % bandwidth
- ▶ Dropper post for added security in downhill

MODELL HIGHLIGHTS

- ▶ Leichte Rock Shox Reba Federgabel
- ▶ 1x12 SRAM Eagle Antrieb mit 500 % Bandbreite
- ▶ Variostütze für mehr Sicherheit im Downhill

LECTOR LC	-	Continental Mountain King II PureGrip 29x2.2 // Continental X-King PureGrip 29x2.2	Fizik Antares R7
Rock Shox Reba RL Solo Air OneLoc 100 mm	SRAM GX Eagle	Rodi Tryp 622x25 mm 32H // Rodi Tryp 622x25 mm 32H	16012
Ground Fiftyone Dia. 31.8 mm	Truvativ Descendant X-Sync 32T	Formula DC-711 15x110 mm	PressFit 92 mm
Ground Fiftyone 740 mm Dia. 31.8 mm	SRAM XG 1275 10-50	Formula DHT-142 12x142 mm SRAM XD	FRHG0002
SRAM GX Eagle 12-S	SRAM Level T 2/2 Piston 180/160 mm Disc	JD Dropper Post 31.6 mm	XS-S-M-L-XL

SIZE	ARTICLENUMBER	NOTES
SIZE XS	18LE1043	
SIZE S	18LE1044	
SIZE M	18LE1045	
SIZE L	18LE1046	
SIZE XL	18LE1047	



NEON FLAT // neon yellow / night black

29 LC **LECTOR** 5.9



MODEL HIGHLIGHTS

- ▶ Lightweight Rock Shox Reba fork
- ▶ 1x12 SRAM Eagle drivetrain with 500 % bandwidth
- ▶ Dropper post for added security in downhill

MODELL HIGHLIGHTS

- ▶ Leichte Rock Shox Reba Federgabel
- ▶ 1x12 SRAM Eagle Antrieb mit 500 % Bandbreite
- ▶ Variostütze für mehr Sicherheit im Downhill

LECTOR LC	-	Continental Mountain King II PureGrip 29x2.2 // Continental X-King PureGrip 29x2.2	Fizik Antares R7
Rock Shox Reba RL Solo Air OneLoc 100 mm	SRAM GX Eagle	Rodi Tryp 622x25 mm 32H // Rodi Tryp 622x25 mm 32H	16012
Ground Fiftyone Dia. 31.8 mm	Truvativ Descendant X-Sync 32T	Formula DC-711 15x110 mm	PressFit 92 mm
Ground Fiftyone 740 mm Dia. 31.8 mm	SRAM XG 1275 10-50	Formula DHT-142 12x142 mm SRAM XD	FRH60002
SRAM GX Eagle 12-S	SRAM Level T 2/2 Piston 180/160 mm Disc	JD Dropper Post 31.6 mm	XS-S-M-L-XL

SIZE	ARTICLENUMBER	NOTES
SIZE XS	18LE1050	
SIZE S	18LE1051	
SIZE M	18LE1052	
SIZE L	18LE1053	
SIZE XL	18LE1054	



MODEL HIGHLIGHTS

- ▶ Shimano 2x11 XT drivetrain
- ▶ FOX 32 Rhythm fork with remote
- ▶ Lightweight and ergonomic GND51 components

MODELL HIGHLIGHTS

- ▶ Shimano 2x11 XT-Antrieb
- ▶ FOX 32 Rhythm Federgabel mit Remote
- ▶ Leichte und ergonomische GND51-Anbauteile

LECTOR LC	Shimano XT FD-M8020 Side Swing	Continental X-King PureGrip 29x2.2 // Continental X-King PureGrip 29x2.2	Fizik Antares R7
Fox Rhythm 32 Float Remote 100 mm	Shimano XT SL-M8000	Rodi Tryp 622x25 mm 32H // Rodi Tryp 622x25 mm 32H	16012
Ground Fiftyone Dia. 31.8 mm	Shimano XT FC-M8000 Hollowtech II 36-26	Formula DC-711 15x110 mm	PressFit 92 mm
Ground Fiftyone 740 mm Dia. 31.8 mm	Shimano SLX CS-M7000 11-42	Formula DHT-142 12x142mm	FRHG0001
Shimano XT RD-M8000 Shadow Plus 11-S	Shimano XT BR-M8000 2/2 Piston 180/160 mm Disc	Ground Fiftyone 31.6 mm	XS-S-M-L-XL

SIZE	ARTICLENUMBER	NOTES
SIZE XS	18LE1029	
SIZE S	18LE1030	
SIZE M	18LE1031	
SIZE L	18LE1032	
SIZE XL	18LE1033	



NEON FLAT // neon orange / night black

29 LC **LECTOR** 4.9



MODEL HIGHLIGHTS

- ▶ Shimano 2x11 XT drivetrain
- ▶ FOX 32 Rhythm fork with remote
- ▶ Lightweight and ergonomic GND51 components

MODELL HIGHLIGHTS

- ▶ Shimano 2x11 XT-Antrieb
- ▶ FOX 32 Rhythm Federgabel mit Remote
- ▶ Leichte und ergonomische GND51-Anbauteile

LECTOR LC	Shimano XT FD-M8020 Side Swing	Continental X-King PureGrip 29x2.2 // Continental X-King PureGrip 29x2.2	Fizik Antares R7
Fox Rhythm 32 Float Remote 100 mm	Shimano XT SL-M8000	Rodi Tryp 622x25 mm 32H // Rodi Tryp 622x25 mm 32H	16012
Ground Fiftyone Dia. 31.8 mm	Shimano XT FC-M8000 Hollowtech II 36-26	Formula DC-711 15x110 mm	PressFit 92 mm
Ground Fiftyone 740 mm Dia. 31.8 mm	Shimano SLX CS-M7000 11-42	Formula DHT-142 12x142 mm	FRHG0001
Shimano XT RD-M8000 Shadow Plus 11-S	Shimano XT BR-M8000 2/2 Piston 180/160 mm Disc	Ground Fiftyone 31.6 mm	XS-S-M-L-XL

SIZE	ARTICLENUMBER	NOTES
SIZE XS	18LE1036	
SIZE S	18LE1037	
SIZE M	18LE1038	
SIZE L	18LE1039	
SIZE XL	18LE1040	



MODEL HIGHLIGHTS

- ▶ FOX 32 Rhythm fork with remote
- ▶ Shimano SLX/XT components
- ▶ Lightweight and ergonomic GND51 components

MODELL HIGHLIGHTS

- ▶ FOX 32 Rhythm Federgabel mit Remote
- ▶ Shimano SLX/ XT Komponenten
- ▶ Leichte und ergonomische GND51-Anbauteile

LECTOR LC	Shimano SLX FD-M7020 Side Swing	Continental X-King PureGrip 29x2.2 // Continental X-King PureGrip 29x2.2	Fizik Antares R7
Fox Rhythm 32 Float Remote 100 mm	Shimano SLX SL-M7000	Rodi Blackrock 622x21 mm 32H // Rodi Blackrock 622x21 mm 32H	16012
Ground Fiftyone Dia. 31.8 mm	Shimano FC-M1700 36-26	Formula DC-711 15x110 mm	PressFit 92 mm
Ground Fiftyone 740 mm Dia. 31.8 mm	Shimano SLX CS-M7000 11-42	Formula DHT-142 12x142 mm	FRHG0001
Shimano XT RD-M8000 Shadow Plus 11-S	Shimano BR-M365 2/2 Piston 180/160 mm Disc	Ground Fiftyone 31.6 mm	XS-S-M-L-XL

SIZE	ARTICLENUMBER	NOTES
SIZE XS	18LE1022	
SIZE S	18LE1023	
SIZE M	18LE1024	
SIZE L	18LE1025	
SIZE XL	18LE1026	



MODEL HIGHLIGHTS

- ▶ FOX 32 Rhythm fork with remote
- ▶ Shimano SLX/XT components
- ▶ Lightweight and ergonomic GND51 components

MODELL HIGHLIGHTS

- ▶ FOX 32 Rhythm Federgabel mit Remote
- ▶ Shimano SLX/ XT Komponenten
- ▶ Leichte und ergonomische GND51-Anbauteile

LECTOR LC	Shimano SLX FD-M7020 Side Swing	Continental X-King PureGrip 29x2.2 // Continental X-King PureGrip 29x2.2	Fizik Antares R7
Fox Rhythm 32 Float Remote 100 mm	Shimano SLX SL-M7000	Rodi Blackrock 622x21 mm 32H // Rodi Blackrock 622x21 mm 32H	16012
Ground Fiftyone Dia. 31.8 mm	Shimano FC-M1700 36-26	Formula DC-711 15x110 mm	PressFit 92 mm
Ground Fiftyone 740 mm Dia. 31.8 mm	Shimano SLX CS-M7000 11-42	Formula DHT-142 12x142 mm	FRHG0001
Shimano XT RD-M8000 Shadow Plus 11-S	Shimano BR-M365 2/2 Piston 180/160 mm Disc	Ground Fiftyone 31.6 mm	XS-S-M-L-XL

SIZE	ARTICLENUMBER	NOTES
SIZE XS	18LE1015	
SIZE S	18LE1016	
SIZE M	18LE1017	
SIZE L	18LE1018	
SIZE XL	18LE1019	



MODEL HIGHLIGHTS

- ▶ Designed especially for smaller riders and athletic women with 27.5"
- ▶ FOX 32 Rhythm fork with remote
- ▶ Lightweight and ergonomic GND51 components

MODELL HIGHLIGHTS

- ▶ Speziell für kleinere Fahrer und sportliche Frauen mit 27.5"
- ▶ FOX 32 Rhythm Federgabel mit Remote
- ▶ Leichte und ergonomische GND51-Anbauteile

LECTOR LC	Shimano SLX FD-M7020 Side Swing	Continental X-King PureGrip 27.5x2.2 // Continental X-King PureGrip 27.5x2.2	Fizik Antares R7
Fox Rhythm 32 Float Remote 100 mm	Shimano SLX SL-M7000	Rodi Blackrock 584x21 mm 32H // Rodi Blackrock 584x21 mm 32H	16012
Ground Fiftyone Dia. 31.8 mm	Shimano FC-MT700 36-26	Formula DC-711 15x110 mm	PressFit 92 mm
Ground Fiftyone 740 mm Dia. 31.8 mm	Shimano SLX CS-M7000 11-42	Formula DHT-142 12x142 mm	FRHG0022
Shimano XT RD-M8000 Shadow Plus 11-S	Shimano BR-M365 2/2 Piston 180/160 mm Disc	Ground Fiftyone 31.6 mm	XS-S-M-L

SIZE	ARTICLENUMBER	NOTES
SIZE XS	18LE3013	
SIZE S	18LE3014	
SIZE M	18LE3015	
SIZE L	18LE3016	



FLAT // jade blue / night black / neon yellow

27.5" LC **LECTOR** 3.7



MODEL HIGHLIGHTS

- ▶ Designed especially for smaller riders and athletic women with 27.5"
- ▶ FOX 32 Rhythm fork with remote
- ▶ Lightweight and ergonomic GND51 components

MODELL HIGHLIGHTS

- ▶ Speziell für kleinere Fahrer und sportliche Frauen mit 27.5"
- ▶ FOX 32 Rhythm Federgabel mit Remote
- ▶ Leichte und ergonomische GND51-Anbauteile

LECTOR LC	Shimano SLX FD-M7020 Side Swing	Continental X-King PureGrip 27.5x2.2 // Continental X-King PureGrip 27.5x2.2	Fizik Antares R7
Fox Rhythm 32 Float Remote 100 mm	Shimano SLX SL-M7000	Rudi Blackrock 584x21 mm 32H // Rudi Blackrock 584x21 mm 32H	16012
Ground Fiftyone Dia. 31.8 mm	Shimano FC-M1700 36-26	Formula DC-711 15x110 mm	PressFit 92 mm
Ground Fiftyone 740 mm Dia. 31.8 mm	Shimano SLX CS-M7000 11-42	Formula DHT-142 12x142 mm	FRH60022
Shimano XT RD-M8000 Shadow Plus 11-S	Shimano BR-M365 2/2 Piston 180/160 mm Disc	Ground Fiftyone 31.6 mm	XS-S-M-L

SIZE	ARTICLENUMBER	NOTES
SIZE XS	18LE3019	
SIZE S	18LE3020	
SIZE M	18LE3021	
SIZE L	18LE3022	



MODEL HIGHLIGHTS

- ▶ Pro-level frame at an affordable, entry-level price point
- ▶ Shimano 2x10 Deore drivetrain
- ▶ Lightweight and ergonomic GND51 components

MODELL HIGHLIGHTS

- ▶ Profirahmen zum einsteigerfreundlichen Preis
- ▶ Shimano 2x10 Deore-Antrieb
- ▶ Leichte und ergonomische GND51-Anbauteile

LECTOR LC	Shimano Deore FD-M6020 Side Swing	Continental X-King PureGrip 29x2.2 // Continental X-King PureGrip 29x2.2	Fizik Antares R7
Rock Shox Recon Gold RL Solo Air OneLoc 100 mm	Shimano Deore SL-M6000	Rodi Blackrock 622x21 mm 32H // Rodi Blackrock 622x21 mm 32H	16012
Ground Fiftyone Dia. 31.8 mm	Shimano Deore FC-M6000 Hollowtech II 34-24	Formula DC-71 15x100 mm	PressFit 92 mm
Ground Fiftyone 740 mm Dia. 31.8 mm	Shimano CS-HG500-10 11-42	Formula DHT-142 12x142 mm	FRHG001
Shimano Deore RD-M6000 Shadow Plus 10-S	Shimano BR-M365 2/2 Piston 180/160 mm Disc	Ground Fiftyone 31.6 mm	XS-S-M-L-XL

SIZE	ARTICLENUMBER	NOTES
SIZE XS	18LE1001	
SIZE S	18LE1002	
SIZE M	18LE1003	
SIZE L	18LE1004	
SIZE XL	18LE1005	



NEON FLAT // neon green / night black

29 LC **LECTOR** 2.9



MODEL HIGHLIGHTS

- ▶ Pro-level frame at an affordable, entry-level price point
- ▶ Shimano 2x10 Deore drivetrain
- ▶ Lightweight and ergonomic GND51 components

MODELL HIGHLIGHTS

- ▶ Profirahmen zum einsteigerfreundlichen Preis
- ▶ Shimano 2x10 Deore-Antrieb
- ▶ Leichte und ergonomische GND51-Anbauteile

LECTOR LC	Shimano Deore FD-M6020 Side Swing	Continental X-King PureGrip 29x2.2 // Continental X-King PureGrip 29x2.2	Fizik Antares R7
Rock Shox Recon Gold RL Solo Air Oneloc 100 mm	Shimano Deore SL-M6000	Rudi Blackrock 622x21 mm 32H // Rudi Blackrock 622x21 mm 32H	16012
Ground Fiftyone Dia. 31.8 mm	Shimano Deore FC-M6000 Hollowtech II 34-24	Formula DC-71 15x100 mm	PressFit 92 mm
Ground Fiftyone 740 mm Dia. 31.8 mm	Shimano CS-HG500-10 11-42	Formula DHT-142 12x142 mm	FRHG0001
Shimano Deore RD-M6000 Shadow Plus 10-S	Shimano BR-M365 2/2 Piston 180/160 mm Disc	Ground Fiftyone 31.6 mm	XS-S-M-L-XL

SIZE	ARTICLENUMBER	NOTES
SIZE XS	18LE1008	
SIZE S	18LE1009	
SIZE M	18LE1010	
SIZE L	18LE1011	
SIZE XL	18LE1012	



MODEL HIGHLIGHTS

- ▶ New Shimano Deore M6000 2x10 groupset
- ▶ Pro-level frame at an affordable, entry-level price point
- ▶ Lightweight and ergonomic GND51 components

MODELL HIGHLIGHTS

- ▶ Neue Shimano Deore M6000 2x10-Gruppe
- ▶ Profirahmen zum einsteigerfreundlichen Preis
- ▶ Leichte und ergonomische GND51-Anbauteile

LECTOR LC	Shimano Deore FD-M6020 Side Swing	Continental X-King PureGrip 27.5x2.2 // Continental X-King PureGrip 27.5x2.2	Fizik Antares R7
Rock Shox Recon Gold RL Solo Air Oneloc 100 mm	Shimano Deore SL-M6000	Rodi Blackrock 584x21 mm 32H // Rodi Blackrock 584x21 mm 32H	16012
Ground Fiftyone Dia. 31.8 mm	Shimano Deore FC-M6000 Hollowtech II 34-24	Formula DC-71 15x100 mm	PressFit 92 mm
Ground Fiftyone 740 mm Dia. 31.8 mm	Shimano CS-HG500-10 11-42	Formula DHT-142 12x142 mm	FRHG0022
Shimano Deore RD-M6000 Shadow Plus 10-S	Shimano BR-M365 2/2 Piston 180/160 mm Disc	Ground Fiftyone 31.6 mm	XS-S-M-L

SIZE	ARTICLENUMBER	NOTES
SIZE XS	18LE3007	
SIZE S	18LE3008	
SIZE M	18LE3009	
SIZE L	18LE3010	



FLAT // night black / night black

27s LC **LECTOR** 2.7



MODEL HIGHLIGHTS

- ▶ New Shimano Deore M6000 2x10 groupset
- ▶ Pro-level frame at an affordable, entry-level price point
- ▶ Lightweight and ergonomic GND51 components

MODELL HIGHLIGHTS

- ▶ Neue Shimano Deore M6000 2x10-Gruppe
- ▶ Profirahmen zum einsteigerfreundlichen Preis
- ▶ Leichte und ergonomische GND51-Anbauteile

LECTOR LC	Shimano Deore FD-M6020 Side Swing	Continental X-King PureGrip 27.5x2.2 // Continental X-King PureGrip 27.5x2.2	Fizik Antares R7
Rock Shox Recon Gold RL Solo Air Oneloc 100 mm	Shimano Deore SL-M6000	Rodi Blackrock 584x21 mm 32H // Rodi Blackrock 584x21 mm 32H	16012
Ground Fiftyone Dia. 31.8 mm	Shimano Deore FC-M6000 Hollowtech II 34-24	Formula DC-71 15x100 mm	PressFit 92 mm
Ground Fiftyone 740 mm Dia. 31.8 mm	Shimano CS-HG500-10 11-42	Formula DHT-142 12x142 mm	FRH60022
Shimano Deore RD-M6000 Shadow Plus 10-S	Shimano BR-M365 2/2 Piston 180/160 mm Disc	Ground Fiftyone 31.6 mm	XS-S-M-L

SIZE	ARTICLENUMBER	NOTES
SIZE XS	18LE3001	
SIZE S	18LE3002	
SIZE M	18LE3003	
SIZE L	18LE3004	

LECTOR^{KID}



26" WHEELSET FOR OUTSTANDING AGILITY // 26"-LAUFRÄDER FÜR HERVORRAGENDE WENDIGKEIT

PROFESSIONAL FRAME FOR AMBITIOUS CLIMBERS // PROFI-RAHMEN FÜR AMBITIONIERTE AUFSTEIGER

FRAME CAN ALSO ACCOMMODATE 27.5" WHEELS // RAHMEN LÄSST SICH AUCH MIT 27,5"-LAUFRÄDERN AUFBAUEN

LIGHTWEIGHT AIR FORK WITH CHILD-APPROPRIATE SUSPENSION TUNING // LEICHTE LUFTGABEL MIT KINDGERECHTEM DÄMPFUNGS-TUNE

SMALL 28T CHAINRING WITH SRAM 1X11 REAR DERAILLEUR // KLEINES 28ER-KETTENBLATT MIT SRAM 1X11-SCHALTUNG

// KIDS / RACE

FEATURES



CHARACTERISTICS

- ▶ Compact frame for optimum agility and playful riding characteristics
- ▶ Child-appropriate package with ergonomically optimized equipment
- ▶ Intuitive handling, easy to use components, full focus on riding
- ▶ Lightweight and stiff for optimum pedaling efficiency of the young and wild

CHARAKTERISTIK

- ▶ Kompakter Rahmen für beste Wendigkeit und spielerisches Fahrverhalten
- ▶ Kindgerechtes Gesamtpaket mit ergonomisch optimierter Ausstattung
- ▶ Intuitives Handling mit unkomplizierten Bedienelementen für vollen Fokus auf die Strecke
- ▶ Leicht und steif für bestmögliche Treteffizienz der jungen Wilden

TARGET GROUP

- ▶ For young upcoming talents and the future heroes of racing

ZIELGRUPPE

- ▶ Für heranwachsende Talente und die zukünftigen Helden des Rennsports



LECTOR KID

// GEOMETRY AND DATA CHARTS / GEOMETRIE UND TECHNISCHE DATEN

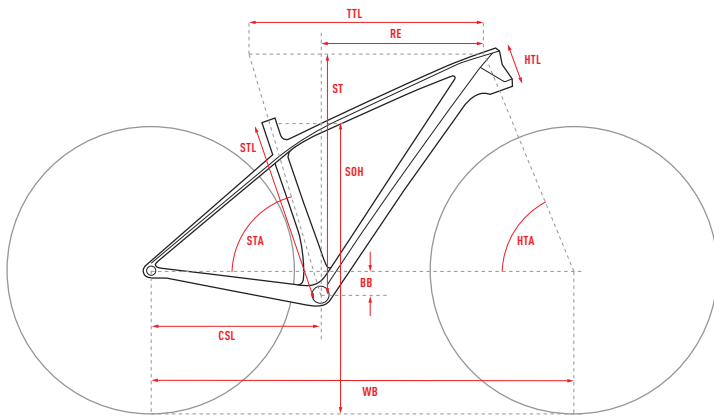

ALL DIMENSIONS IN MM (EXCEPT HTA AND STA IN °)

ALLE MASSE IN MM (AUSNAHME HTA UND STA IN °)

STL	SEAT TUBE LENGTH SITZROHRLÄNGE		SHOCK HARDWARE (Ø 8MM) DÄMPFERBUCHSENMASSE (Ø 8MM)
CSL	CHAINSTAY LENGTH KETTENSTREBENLÄNGE		SHOCK LENGTH DÄMPFEREINBAULÄNGE
TTL	TOP TUBE LENGTH OBERROHRLÄNGE		SHOCK TRAVEL DÄMPFERHUB
HTL	HEADTUBE LENGTH STEUERROHRLÄNGE		FRONT FORK TRAVEL FEDERWEG VORNE
HTA	HEADTUBE ANGLE STEUERROHRWINKEL		REAR WHEEL TRAVEL FEDERWEG HINTEN
STA	SEATTUBE ANGLE SITZROHRWINKEL		MIN SADDLE HEIGHT MIN SÄTTELHÖHE
BB	BB DROP TRETLAGERABSSENKUNG		MAX SADDLE HEIGHT MAX SÄTTELHÖHE
WB	WHEELBASE RADSTAND		MIN INSEAM MIN SCHRITTLÄNGE
ST	STACK STACK		MAX INSEAM MAX SCHRITTLÄNGE
RE	REACH REACH		STEM LENGTH VORBAULÄNGE
SOH	STANDOVER HEIGHT ÜBERSTANDSHÖHE		HANDLEBAR WIDTH LENKERBREITE
	HEAD SET DIAMETER (UPPER / LOWER) STEUERSATZDURCHMESSER (OBEN / UNTEN)		CRANK LENGTH KURBELLÄNGE
	AXLE STANDARD (REAR / FRONT) ACHSENSTANDARD (HINTEN / VORNE)		SEATTUBE BOTTLE MOUNT FLASCHE SÄTTELROHR
	BOTTOM BRACKET STANDARD TRETLAGERSTANDARD		DOWNTUBE BOTTLE MOUNT FLASCHE UNTERROHR
	SEAT POST DIAMETER SÄTTELSTÜTZENDURCHMESSER		

STL CSL TTL HTL HTA STA BB WB ST RE SOH ST DT

LECTOR 1.6 LC U

XS	380	423	550	100.5	69.5	74.6	51	1052	576	391	650	ZS44/ZS56	142/100	Pressfit92	31.6	100	/	/	620	730	35	580	155	/	0.75
----	-----	-----	-----	-------	------	------	----	------	-----	-----	-----	-----------	---------	------------	------	-----	---	---	-----	-----	----	-----	-----	---	------



NEON FLAT // neon yellow / night black

26 LC **LECTOR** KID 1.6



MODEL HIGHLIGHTS

- ▶ Eurobike Award winner
- ▶ Kids' specific race bike
- ▶ True LECTOR features and geometry

MODELL HIGHLIGHTS

- ▶ Eurobike-Award-Gewinner
- ▶ Kinderspezifisches Racebike
- ▶ Echte LECTOR-Features und -Geometrie

LECTOR LC	-	Continental X-King PureGrip 26x2.2 // Continental X-King PureGrip 26x2.2	Fizik Antares R7
XFusion Velvet RL2 100 mm	SRAM NX	Rodi Excalibur XC 2 559x19 mm 32H // Rodi Excalibur XC 2 559x19 mm 32H	16012
GHOST MTB Dia. 31.8 mm	GHOST 28T	Formula DC-71 15x100 mm	PressFit 92 mm
GHOST Low Rizer MTB 580 mm Rise 15 mm Dia. 31.8 mm	SRAM PG-1130 11-42	Formula GHL-360 12x142 mm	FRHG0021
SRAM NX 11-S	Tektro HD-M282 2/2 Piston 160 mm Disc	GHOST Light DC 1 31.6 mm	XS

SIZE	ARTICLENUMBER	NOTES
ONE SIZE	18LE4001	

ROKET X



PARTICULARLY ROBUST ALUMINUM HARDTAIL FRAME WITH MODERN OFFROAD GEOMETRY // BESONDERS ROBUSTER ALU-HARDTAIL-RAHMEN MIT MODERNER OFFROAD-GEOMETRIE

USB PORT FOR CHARGING ELECTRONICS (GPS, LIGHTING ETC.) // USB-PORT FÜR MOBILES LADEN ELEKTRONISCHER ENDGERÄTE (GPS, BELEUCHTUNG ETC.)

COMES WITH ADAPTABLE AMR BAG PACKING SYSTEM // KOMMT MIT WANDLUNGSFAHIGEM AMR-TASCHENSYSTEM

27.5" WHEELSET FOR SAFE HANDLING AND COMFORTABLE ROLL-OVER PROPERTIES // 27.5"-BEREIFUNG FÜR SICHERES HANDLING UND KOMFORTABLES ÜBERROLLVERHALTEN

LOW MAINTENANCE, ENCLOSED PINION DRIVETRAIN // GEKAPSELTER UND WARTUNGSARMER GETRIEBEANTRIEB VON PINION

// BACKCOUNTRY / ADVENTURE

FEATURES



CHARACTERISTICS

- ▶ Thought-out detailed solutions for self-sufficient multi-day tours
- ▶ Single trail oriented adventure bike that does not shy away from wild trail rides
- ▶ Great stability even with fully loaded bags
- ▶ Clever storage space for your belongings with the AMR bag packing system

CHARAKTERISTIK

- ▶ Ausgefeilte Detaillösungen für autarke Mehrtagestouren
- ▶ Singletrail-orientiertes Abenteuerbike, das auch vor wilden Trail-Ausfahrten nicht zurückschreckt
- ▶ Hohe Fahrstabilität auch bei voller Ladung der Gepäcktaschen
- ▶ Smarter Stauraum für Gepäck im AMR-Taschensystem

TARGET GROUP

- ▶ Explorers who are looking for the thrill of self-determined freedom of mobility and who know how to benefit from clever detailed solutions



ZIELGRUPPE

- ▶ Abenteuerer, die den Genuss der selbstbestimmten Bewegungsfreiheit suchen und smarte Detaillösungen für sich zu nutzen wissen

ROKET X

// GEOMETRY AND DATA CHARTS / GEOMETRIE UND TECHNISCHE DATEN

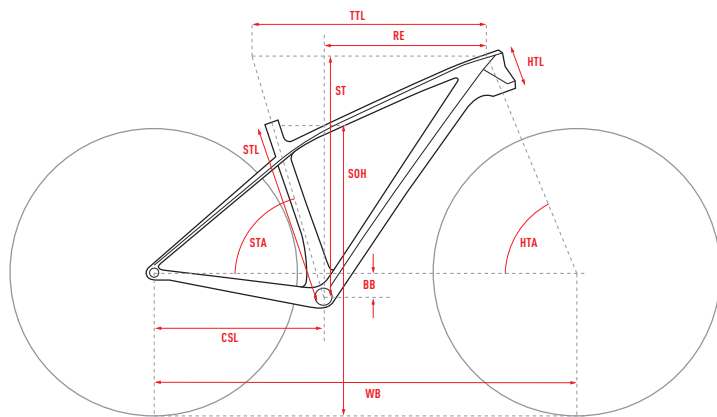













ALL DIMENSIONS IN MM (EXCEPT HTA AND STA IN °)

ALLE MASSE IN MM (AUSNAHME HTA UND STA IN °)

- STL** SEAT TUBE LENGTH
SITZROHRLÄNGE
- CSL** CHAINSTAY LENGTH
KETTENSTREBENLÄNGE
- TTL** TOP TUBE LENGTH
OBERROHRLÄNGE
- HTL** HEADTUBE LENGTH
STEUERROHRLÄNGE
- HTA** HEADTUBE ANGLE
STEUERROHRWINKEL
- STA** SEATTUBE ANGLE
SITZROHRWINKEL
- BB** BB DROP
TRETLAGERABSSENKUNG
- WB** WHEELBASE
RADSTAND
- ST** STACK
STACK
- RE** REACH
REACH
- SOH** STANDOVER HEIGHT
ÜBERSTANDSHÖHE
-  **HEAD SET DIAMETER (UPPER / LOWER)**
STEUERSATZDURCHMESSER (OBEN / UNTEN)
-  **AXLE STANDARD (REAR / FRONT)**
ACHSENSTANDARD (HINTEN / VORNE)
-  **BOTTOM BRACKET STANDARD**
TRETLAGERSTANDARD
-  **SEAT POST DIAMETER**
SITZELSTÜTZENDURCHMESSER
-  **SHOCK HARDWARE (Ø 8MM)**
DÄMPFERBUCHSENMASSE (Ø 8MM)
-  **SHOCK LENGTH**
DÄMPFEREINBAULÄNGE
-  **SHOCK TRAVEL**
DÄMPFERHUB
-  **FRONT FORK TRAVEL**
FEDERWEG VORNE
-  **REAR WHEEL TRAVEL**
FEDERWEG HINTEN
-  **MIN SADDLE HEIGHT**
MIN SITZTELHÖHE
-  **MAX SADDLE HEIGHT**
MAX SITZTELHÖHE
-  **MIN INSEAM**
MIN SCHRITTLÄNGE
-  **MAX INSEAM**
MAX SCHRITTLÄNGE
-  **STEM LENGTH**
VORBAULÄNGE
-  **HANDLEBAR WIDTH**
LENKERBREITE
-  **CRANK LENGTH**
KURBELLÄNGE
-  **SEATTUBE BOTTLE MOUNT**
FLASCHE SATTELROHR
-  **DOWNTUBE BOTTLE MOUNT**
FLASCHE UNTERROHR

STL CSL TTL HTL HTA STA BB WB ST RE SOH             

ROKET X 8.7+ AL U

	STL	CSL	TTL	HTL	HTA	STA	BB	WB	ST	RE	SOH																		
S	380	435	586	110	67	74	56	1131	630	405	695	ZS44/ZS56	148/110	Pinion	31.6	/	/	/	130	/	55	760	175	/	0.75				
M	420	435	606	110	67	74	56	1151	630	425	703	ZS44/ZS56	148/110	Pinion	31.6	/	/	/	130	/	55	760	175	/	0.75				
L	460	435	623	120	67	74	56	1170	630	440	735	ZS44/ZS56	148/110	Pinion	31.6	/	/	/	130	/	55	760	175	/	0.75				



MODEL HIGHLIGHTS

- ▶ Pinion C1.12 gear system
- ▶ AMR pack system included
- ▶ Boost hub dynamo with USB port at the stem

MODELL HIGHLIGHTS

- ▶ Pinion C1.12 Getriebe
- ▶ AMR-Taschensystem inklusive
- ▶ Boost-Nabendynamo mit USB-Ladebuchse am Vorbau

ROKET AL Pinion	-	Schwalbe Nobby Nic TrailStar 27.5x2.8 // Schwalbe Rocket Ron PaceStar 27.5x2.8	SD6 Fly Mountain
Rock Shox Yari RC Solo Air 130 mm	Pinion C1.12	Race Face ARC 40 584x40 mm 32H // Race Face ARC 40 584x40 mm 32H	16012
GHOST MTB Dia. 35 mm	Pinion 24T	Shutter Precision Dynamo Hub 15x110 mm	Pinion
GHOST Low Rizer MTB 760 mm Rise 15 mm Dia. 35 mm	Pinion 21T	Formula DC-1248 12x148 mm	FRH60059
Pinion C1.12	SRAM Guide R 4/4 Piston 200/180 mm Disc	Kind Shock LEV Integra 31.6 mm	S-M-L

SIZE	ARTICLENUMBER	NOTES
SIZE S	18R02001	
SIZE M	18R02002	
SIZE L	18R02003	

ROKET



PARTICULARLY ROBUST ALUMINUM HARDTAIL FRAME WITH MODERN OFFROAD GEOMETRY // BESONDERS ROBUSTER ALU-HARDTAIL-RAHMEN MIT MODERNER OFFROAD-GEOMETRIE



27.5"+ WHEELSET FOR SUPERIOR HANDLING AND COMFORTABLE ROLL-OVER PROPERTIES // 27.5"+-BEREIFUNG FÜR SOUVERÄNES HANDLING UND KOMFORTABLES ÜBERROLLVERHALTEN



THOUGHT-OUT EQUIPMENT FOR VERY COMFORTABLE RIDES IN TERRAIN // DURCHDACHTE AUSSTATTUNG FÜR HOHEN FAHRKOMFORT IM GELÄNDE

// BACKCOUNTRY / ALLROUND

FEATURES



CHARACTERISTICS

- ▶ Particularly robust long-distance bike with reliable components
- ▶ Comfort oriented adventure bike which makes you feel very safe off the pavement as well
- ▶ Versatile allrounder which performs equally well with 29" wheels for long tours off the rough trails

CHARAKTERISTIK

- ▶ Besonders robustes Langstreckenbike mit zuverlässigen Anbauteilen
- ▶ Komfort-orientiertes Abenteuerbike, das auch abseits befestigter Wege besonders viel Sicherheit vermittelt
- ▶ Vielseitiger Alleskönner, der für lange Touren abseits ruppiger Trails auch mit 29"-Laufrädern funktioniert

TARGET GROUP

- ▶ Self-proclaimed pleasure bikers looking for relaxation outdoors and who are set on discovering unknown territory

DOWNHILL

COMFORTABLE

UPHILL

EFFICIENT

TOUGH

LEISURE

LIGHTWEIGHT

COMPETITION

SMOOTH

INTUITIVE

PLAYFUL

COMPLEX

ZIELGRUPPE

- ▶ Selbstbestimmte Genuss-Biker, die Erholung in freier Natur suchen und in unentdeckte Regionen vordringen möchten



FLAT // army green / night black / riot red

27.5+ AL **ROKET** 5.7+



MODEL HIGHLIGHTS

- ▶ Reliable adventurer with great versatility
- ▶ 1x drivetrain for hassle-free pedaling with 11-46 cassette

MODELL HIGHLIGHTS

- ▶ Zuverlässiger Abenteurer mit großem Einsatzbereich
- ▶ 1x Antrieb für sorgenfreies Pedalieren mit 11-46 Abstufung

ROKET AL	-	WTB Trail Boss 27.5x2.65 // WTB Trail Boss 27.5x2.65	SDG Fly Mountain
SR Suntour Aion 35 LO-R DS 130 mm	Shimano SLX SL-M7000	WTB STp i29 584x29 mm 32H // WTB STp i29 584x29 mm 32H	16012
Ground Fiftyone Dia. 31.8 mm	Race Face Aeffect 32T	Formula DC-711 15x110 mm	PressFit 92 mm
Ground Fiftyone Race 780 mm Rise 15 mm Dia. 31.8 mm	Shimano SLX CS-M7000 11-46	Formula DC-1248 12x148 mm	FRHG0022
Shimano SLX RD-M7000 Shadow Plus 11-S	Tektro HD-M285 2/2 Piston 180 mm Disc	Ground Fiftyone 31.6 mm	S-M-L

SIZE	ARTICLENUMBER	NOTES
SIZE S	18R01001	
SIZE M	18R01002	
SIZE L	18R01003	



// ALLROUND / TOUR

FEATURES



CHARACTERISTICS

- ▶ The renowned KATO FS geometry offers playful handling
- ▶ The plush AMR four-bar-linkage chassis guarantees the successful split between efficiency and gulping suspension performance
- ▶ Tour-specific equipment options offer tremendous comfort on long tours
- ▶ The compact cockpit offers a pleasantly upright seating position

CHARAKTERISTIK

- ▶ Die renommierte KATO FS-Geometrie bietet ein spielerisches Handling
- ▶ Dem satten AMR-Viergelenkfahwerk gelingt der Spagat zwischen Effizienz und Schluckfreudigkeit
- ▶ Tourenspezifische Ausstattungsvarianten bieten auch auf langen Touren viel Komfort
- ▶ Das kompakte Cockpit bietet eine angenehm aufrechte Sitzposition

TARGET GROUP

- ▶ Fun oriented mountainbikers looking for a capable allrounder

ZIELGRUPPE

- ▶ Fahrspaßorientierte Mountainbiker, die einen leistungsfähigen Allrounder suchen



// GEOMETRY AND DATA CHARTS / GEOMETRIE UND TECHNISCHE DATEN

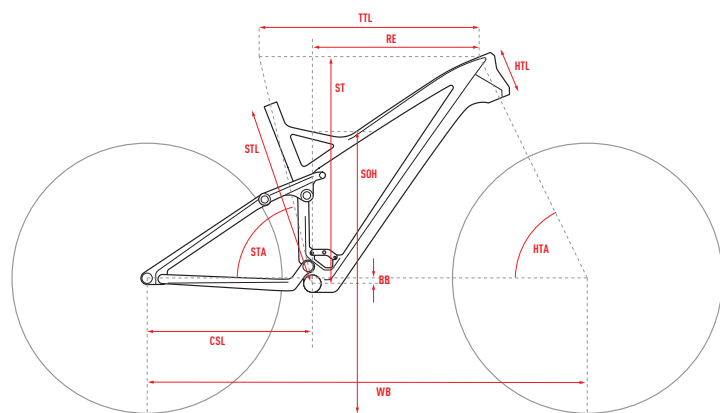

ALL DIMENSIONS IN MM (EXCEPT HTA AND STA IN °)

ALLE MASSE IN MM (AUSNAHME HTA UND STA IN °)

- STL** SEAT TUBE LENGTH
SITZROHRLÄNGE
- CSL** CHAINSTAY LENGTH
KETTENSTREBENLÄNGE
- TTL** TOP TUBE LENGTH
OBERROHRLÄNGE
- HTL** HEADTUBE LENGTH
STEUERROHRLÄNGE
- HTA** HEADTUBE ANGLE
STEUERROHRWINKEL
- STA** SEATTUBE ANGLE
SITZROHRWINKEL
- BB** BB DROP
TRETLAGERABSSENKUNG
- WB** WHEELBASE
RADSTAND
- ST** STACK
STACK
- RE** REACH
REACH
- SOH** STANDOVER HEIGHT
ÜBERSTANDSHÖHE
- [Icon]** HEAD SET DIAMETER (UPPER / LOWER)
STEUERSATZDURCHMESSER (OBEN / UNTEN)
- [Icon]** AXLE STANDARD (REAR / FRONT)
ACHSENSTANDARD (HINTEN / VORNE)
- [Icon]** BOTTOM BRACKET STANDARD
TRETLAGERSTANDARD
- [Icon]** SEAT POST DIAMETER
SITZELSTÜTZENDURCHMESSER
- [Icon]** SHOCK HARDWARE (Ø 8MM)
DÄMPFERBUCHSENMASSE (Ø 8MM)
- [Icon]** SHOCK LENGTH
DÄMPFEREINBAULÄNGE
- [Icon]** SHOCK TRAVEL
DÄMPFERHUB
- [Icon]** FRONT FORK TRAVEL
FEDERWEG VORNE
- [Icon]** REAR WHEEL TRAVEL
FEDERWEG HINTEN
- [Icon]** MIN SADDLE HEIGHT
MIN SÄTTELHÖHE
- [Icon]** MAX SADDLE HEIGHT
MAX SÄTTELHÖHE
- [Icon]** MIN INSEAM
MIN SCHRITTLÄNGE
- [Icon]** MAX INSEAM
MAX SCHRITTLÄNGE
- [Icon]** STEM LENGTH
VORBAULÄNGE
- [Icon]** HANDLEBAR WIDTH
LENKERBREITE
- [Icon]** CRANK LENGTH
KURBELLENGE
- [Icon]** SEATTUBE BOTTLE MOUNT
FLASCHE SÄTTELROHR
- [Icon]** DOWNTUBE BOTTLE MOUNT
FLASCHE UNTERROHR

STL CSL TTL HTL HTA STA BB WB ST RE SOH [Icons]

KATO FS 5.7 / 3.7/ 2.7 ALU

	STL	CSL	TTL	HTL	HTA	STA	BB	WB	ST	RE	SOH	[Icon]	[Icon]	[Icon]	[Icon]	[Icon]	[Icon]	[Icon]	[Icon]	[Icon]	[Icon]	[Icon]	[Icon]	[Icon]	[Icon]	[Icon]
S	420	430	575	110	69	75	15	1114	587	418	700	ZS44/ZS56	135/100	BSA68	31.6	30/22.2	200	51	130	130	60	760	175	/	0.5	
M	460	430	600	120	69	75	15	1141	597	440	745	ZS44/ZS56	135/100	BSA68	31.6	30/22.2	200	51	130	130	60	760	175	/	0.75	
L	500	430	625	130	69	75	15	1166	606	462	755	ZS44/ZS56	135/100	BSA68	31.6	30/22.2	200	51	130	130	75	760	175	/	0.75	
XL	540	430	645	140	69	75	15	1182	615	475	785	ZS44/ZS56	135/100	BSA68	31.6	30/22.2	200	51	130	130	75	760	175	/	0.75	



NEON FLAT // neon orange / night black

27.5 AL **KATO FS 5.7**



MODEL HIGHLIGHTS

- ▶ High-end FOX suspension with lockout
- ▶ Shimano XT components
- ▶ Quality brand Selle Italia saddle

MODELL HIGHLIGHTS

- ▶ High-End FOX Fahrwerk mit Lockout
- ▶ Shimano XT Ausstattung
- ▶ Selle Italia Markensattel

KATO FS AL	Shimano XT FD-M8020 Side Swing	Rodi Blackrock 584x21 mm 32H // Rodi Blackrock 584x21 mm 32H	BSA 68 mm
Fox 32 Float Performance 130 mm	Shimano XT SL-M8000	Shimano Deore HB-M6010 15x100 mm	E21954
Fox Float DPS Performance Air 130 mm	Shimano XT FC-M8000 Hollowtech II 36-26	Shimano Deore FH-M6000 DR	S-M-L-XL
GHOST MTB Dia. 31.8 mm	Shimano SLX CS-M7000 11-42	GHOST Light DC 1 31.6 mm	
GHOST Low Rizer MTB 760 mm Rise 15 mm Dia. 31.8 mm	Shimano XT BR-M8000 2/2 Piston 180 mm Disc	Selle Italia X-Base	
Shimano XT RD-M8000 Shadow Plus 11-S	Continental X-King PureGrip 27.5x2.2 // Continental X-King PureGrip 27.5x2.2	16012	

SIZE	ARTICLENUMBER	NOTES
SIZE S	18KA6043	
SIZE M	18KA6044	
SIZE L	18KA6045	
SIZE XL	18KA6046	



MODEL HIGHLIGHTS

- ▶ High-end FOX suspension with lockout
- ▶ Shimano XT components
- ▶ Quality brand Selle Italia saddle

MODELL HIGHLIGHTS

- ▶ High-End FOX Fahrwerk mit Lockout
- ▶ Shimano XT Ausstattung
- ▶ Selle Italia Markensattel

KATO FS AL	Shimano XT FD-M8020 Side Swing	Rodi Blackrock 584x21 mm 32H // Rodi Blackrock 584x21 mm 32H	BSA 68 mm
Fox 32 Float Performance 130 mm	Shimano XT SL-M8000	Shimano Deore HB-M6010 15x100 mm	EZ1954
Fox Float DPS Performance Air 130 mm	Shimano XT FC-M8000 Hollowtech II 36-26	Shimano Deore FH-M6000 QR	S-M-L-XL
GHOST MTB Dia. 31.8 mm	Shimano SLX CS-M7000 11-42	GHOST Light DC 1 31.6 mm	
GHOST Low Rizer MTB 760 mm Rise 15 mm Dia. 31.8 mm	Shimano XT BR-M8000 2/2 Piston 180 mm Disc	Selle Italia X-Base	
Shimano XT RD-M8000 Shadow Plus 11-S	Continental X-King PureGrip 27.5x2.2 // Continental X-King PureGrip 27.5x2.2	16012	

SIZE	ARTICLENUMBER	NOTES
SIZE S	18KA6037	
SIZE M	18KA6038	
SIZE L	18KA6039	
SIZE XL	18KA6040	



MODEL HIGHLIGHTS

- ▶ AMR-Series technology
- ▶ Shimano SLX/XT components
- ▶ Reliable and lightweight Suntour AION fork with 34 mm stanchions

MODELL HIGHLIGHTS

- ▶ Technologie der AMR-Serie
- ▶ Shimano SLX/ XT Komponenten
- ▶ Zuverlässige und leichte Suntour AION Federgabel mit 34 mm Standrohren

KATO FS AL	Shimano SLX FD-M7020 Side Swing	Rodi Excalibur XC 584x19 mm 32H // Rodi Excalibur XC 584x19 mm 32H	BSA 68 mm
SR Suntour AION LO-R 130 mm	Shimano SLX SL-M7000	Shimano Deore HB-M6010 15x100 mm	E21954
XFusion O2 Pro RL Air 130 mm	Shimano FC-MT600 36-26	Shimano Deore FH-M6000 DR	S-M-L-XL
GHOST MTB Dia. 31.8 mm	Shimano SLX CS-M7000 11-42	GHOST Light DC 1 31.6 mm	
GHOST Low Rizer MTB 760 mm Rise 15 mm Dia. 31.8 mm	Shimano 506 Disc 2/2 Piston 180 mm Disc	Selle Italia X-Base	
Shimano XT RD-M8000 Shadow Plus 11-S	Continental X-King PureGrip 27.5x2.2 // Continental X-King PureGrip 27.5x2.2	16012	

SIZE	ARTICLENUMBER	NOTES
SIZE S	18KA6019	
SIZE M	18KA6020	
SIZE L	18KA6021	
SIZE XL	18KA6022	



MODEL HIGHLIGHTS

- ▶ AMR-Series technology
- ▶ Shimano SLX/XT components
- ▶ Reliable and lightweight Suntour AION fork with 34 mm stanchions

MODELL HIGHLIGHTS

- ▶ Technologie der AMR-Serie
- ▶ Shimano SLX/ XT Komponenten
- ▶ Zuverlässige und leichte Suntour AION Federgabel mit 34 mm Standrohren

KATO FS AL	Shimano SLX FD-M7020 Side Swing	Rodi Excalibur XC 584x19 mm 32H // Rodi Excalibur XC 584x19 mm 32H	BSA 68 mm
SR Suntour AION LO-R 130 mm	Shimano SLX SL-M7000	Shimano Deore HB-M6010 15x100 mm	EZ1954
XFusion 02 Pro RL Air 130 mm	Shimano FC-MT600 36-26	Shimano Deore FH-M6000 QR	S-M-L-XL
GHOST MTB Dia. 31.8 mm	Shimano SLX CS-M7000 11-42	GHOST Light DC 1 31.6 mm	
GHOST Low Rizer MTB 760 mm Rise 15 mm Dia. 31.8 mm	Shimano 506 Disc 2/2 Piston 180 mm Disc	Selle Italia X-Base	
Shimano XT RD-M8000 Shadow Plus 11-S	Continental X-King PureGrip 27.5x2.2 // Continental X-King PureGrip 27.5x2.2	16012	

SIZE	ARTICLENUMBER	NOTES
SIZE S	18KA6013	
SIZE M	18KA6014	
SIZE L	18KA6015	
SIZE XL	18KA6016	



NEON FLAT // neon yellow / night black / urban gray

27.5 AL **KATO FS 2.7**



MODEL HIGHLIGHTS

- ▶ New Shimano Deore M6000 2x10 groupset
- ▶ Lockout suspension by XFusion and RST
- ▶ Quality brand Selle Italia saddle

MODELL HIGHLIGHTS

- ▶ Neue Shimano Deore M6000 2x10-Gruppe
- ▶ Blockierbares Fahrwerk von XFusion und RST
- ▶ Selle Italia Markensattel

KATO FS AL	Shimano Deore FD-M6020 Side Swing	Rodi Excalibur XC 584x19 mm 32H // Rodi Excalibur XC 584x19 mm 32H	BSA 68 mm
RST Aerial TnL Air LO 130 mm	Shimano Deore SL-M6000	Formula DC 20 QR	E21954
XFusion O2 Pro RL Air 130 mm	Shimano Deore FC-M6000 Hollowtech II 34-24	Formula DC 22 QR	S-M-L-XL
GHOST MTB Dia. 31.8 mm	Shimano CS-HG500-10 11-42	GHOST Light DC 1 31.6 mm	
GHOST Low Rizer MTB 760 mm Rise 15 mm Dia. 31.8 mm	Tektro HD-M285 2/2 Piston 180 mm Disc	Selle Italia X-Base	
Shimano Deore RD-M6000 Shadow Plus 10-S	Continental X-King PureGrip 27.5x2.2 // Continental X-King PureGrip 27.5x2.2	16012	

SIZE	ARTICLENUMBER	NOTES
SIZE S	18KA6007	
SIZE M	18KA6008	
SIZE L	18KA6009	
SIZE XL	18KA6010	



MODEL HIGHLIGHTS

- ▶ New Shimano Deore M6000 2x10 groupset
- ▶ Lockout suspension by XFusion and RST
- ▶ Quality brand Selle Italia saddle

MODELL HIGHLIGHTS

- ▶ Neue Shimano Deore M6000 2x10-Gruppe
- ▶ Blockierbares Fahrwerk von XFusion und RST
- ▶ Selle Italia Markensattel

KATO FS AL	Shimano Deore FD-M6020 Side Swing	Rodi Excalibur XC 584x19 mm 32H // Rodi Excalibur XC 584x19 mm 32H	BSA 68 mm
RST Aerial TnL Air LO 130 mm	Shimano Deore SL-M6000	Formula DC 20 QR	Ez1954
XFusion O2 Pro RL Air 130 mm	Shimano Deore FC-M6000 Hollowtech II 34-24	Formula DC 22 QR	S-M-L-XL
GHOST MTB Dia. 31.8 mm	Shimano CS-HG500-10 11-42	GHOST Light DC 1 31.6 mm	
GHOST Low Rizer MTB 760 mm Rise 15 mm Dia. 31.8 mm	Tektro HD-M285 2/2 Piston 180 mm Disc	Selle Italia X-Base	
Shimano Deore RD-M6000 Shadow Plus 10-S	Continental X-King PureGrip 27.5x2.2 // Continental X-King PureGrip 27.5x2.2	16012	

SIZE	ARTICLENUMBER	NOTES
SIZE S	18KA6001	
SIZE M	18KA6002	
SIZE L	18KA6003	
SIZE XL	18KA6004	



// ALLROUND / FUN

FEATURES



CHARACTERISTICS

- ▶ The new geometry yields an exceptionally versatile hardtail
- ▶ The latest standards like front and back thru-axles create an especially efficient unit
- ▶ Progressive components simplify handling
- ▶ Thanks to the low top tube and short seat tube this bike excels in comfort and gives you plenty of space to move

CHARAKTERISTIK

- ▶ Die neue Geometrie resultiert in einem unvergleichbar vielseitigen Hardtail
- ▶ Moderne Standards wie Steckachsen vorn und hinten ergeben eine besonders effiziente Einheit
- ▶ Fortschrittliche Komponenten vereinfachen die Handhabung
- ▶ Dank tiefgezogenem Oberrohr und kurzem Sitzrohr besticht das Bike mit Bewegungsfreiheit und Komfort

TARGET GROUP

- ▶ Worry-free allrounder for all who are looking for a lot of fun on all kinds of trails

ZIELGRUPPE

- ▶ Sorgenfreier Allrounder für alle, die viel Spaß auf Trails aller Art suchen





SHINY // riot red / night black / star white

29 AL **KATO X 6.9**



MODEL HIGHLIGHTS

- ▶ High level, lightweight Suntour AXON fork
- ▶ 1x12 SRAM Eagle drivetrain with 500 % bandwidth
- ▶ DT Swiss M 1900 Spline wheelset

MODELL HIGHLIGHTS

- ▶ Hochwertige und leichte Suntour AXON Gabel
- ▶ 1x12 SRAM Eagle Antrieb mit 500 % Bandbreite
- ▶ DT Swiss M 1900 Spline Laufradsatz

KATO AL	-	Schwalbe Rocket Ron Addix SpeedGrip 29x2.25 // Schwalbe Racing Ralph Addix SpeedGrip 29x2.25	PressFit 92 mm
SR Suntour AXON LO-R 120 mm	SRAM GX Eagle	DT Swiss M 1900 Spline 22.5 mm Wheelset 15x100 mm // DT Swiss M 1900 Spline 22.5 mm Wheelset 12x148 mm SRAM XD	FRH60021
GHOST MTB Dia. 31.8 mm	Race Face Aeffect 32T	GHOST Light DC 1 31.6 mm	S-M-L
GHOST Low Rizer MTB 760 mm Rise 15 mm Dia. 31.8 mm	SRAM XG 1275 10-50	Selle Italia X-Base	
SRAM GX Eagle 12-S	Magura MT Thirty2 4/2 Piston 180 mm Disc	16012	

SIZE	ARTICLENUMBER	NOTES
SIZE S	18KX1006	
SIZE M	18KX1007	
SIZE L	18KX1008	



MODEL HIGHLIGHTS

- ▶ New frame with new geometry
- ▶ Updated with stiff 12 mm through axles
- ▶ Fun focused setup

MODELL HIGHLIGHTS

- ▶ Neuer Rahmen mit neuer Geometrie
- ▶ Jetzt mit steifer 12 mm Steckachse
- ▶ Spassorientierte Ausstattung

KATO AL	-	Continental X-King PureGrip 29x2.2 // Continental X-King PureGrip 29x2.2	Selle Italia X-Base
SR Suntour Raidon 34 XC LO-R Air 120 mm	Shimano SLX SL-M7000	Rodi Blackrock 622x21 mm 32H // Rodi Blackrock 622x21 mm 32H	16012
GHOST MTB Dia. 31.8 mm	Race Face Aeffect 32T	Formula DC-71 15x100 mm	PressFit 92 mm
GHOST Low Rizer MTB 760 mm Rise 15 mm Dia. 31.8 mm	Sunrace MS8-E 11-46	Formula DC-1248 12x148 mm	FRHG0022
Shimano SLX RD-M7000 Shadow Plus 11-S	Tektro HD-M285 2/2 Piston 180 mm Disc	GHOST Light DC 1 31.6 mm	S-M-L

SIZE	ARTICLENUMBER	NOTES
SIZE S	18KX1001	
SIZE M	18KX1002	
SIZE L	18KX1003	



// ALLROUND / TOUR

FEATURES



CHARACTERISTICS

- ▶ The trusted geometry offers quality riding characteristics in any situation
- ▶ Attractive designs make for a timeless bike holding its value
- ▶ Durable components you can count on longterm

CHARAKTERISTIK

- ▶ Die bewährte Geometrie bietet beste Fahreigenschaften in jeder Situation
- ▶ Gefällige Designs ergeben ein zeitlos-wertstabiles Bike
- ▶ Haltbare Komponenten lassen dich auch auf Dauer nicht im Stich

TARGET GROUP

- ▶ For all bikers, who are looking for a high quality entry into MTB riding

ZIELGRUPPE

- ▶ Für alle Biker, die einen hochwertigen Einstieg in den MTB-Sport suchen



// GEOMETRY AND DATA CHARTS / GEOMETRIE UND TECHNISCHE DATEN

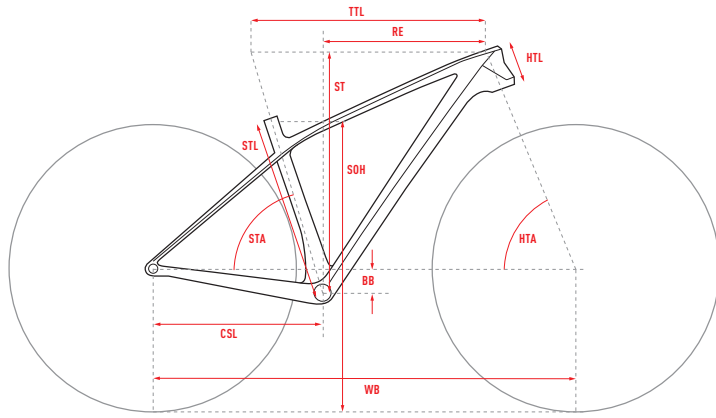

ALL DIMENSIONS IN MM (EXCEPT HTA AND STA IN °)

ALLE MASSE IN MM (AUSNAHME HTA UND STA IN °)

- STL** SEAT TUBE LENGTH
SITZROHRLÄNGE
- CSL** CHAINSTAY LENGTH
KETTENSTREBENLÄNGE
- TTL** TOP TUBE LENGTH
OBERROHRLÄNGE
- HTL** HEADTUBE LENGTH
STEUERROHRLÄNGE
- HTA** HEADTUBE ANGLE
STEUERROHRWINKEL
- STA** SEATTUBE ANGLE
SITZROHRWINKEL
- BB** BB DROP
TRETLAGERABSENKUNG
- WB** WHEELBASE
RADSTAND
- ST** STACK
STACK
- RE** REACH
REACH
- SOH** STANDOVER HEIGHT
ÜBERSTANDSHÖHE
- HSD** HEAD SET DIAMETER (UPPER / LOWER)
STEUERSATZDURCHMESSER (OBEN / UNTEN)
- AS** AXLE STANDARD (REAR / FRONT)
ACHSENSTANDARD (HINTEN / VORNE)
- BS** BOTTOM BRACKET STANDARD
TRETLAGERSTANDARD
- SP** SEAT POST DIAMETER
SITTELSTÜTZENDURCHMESSER
- SH** SHOCK HARDWARE (Ø 8MM)
DÄMPFERBUCHSENMASSE (Ø 8MM)
- SL** SHOCK LENGTH
DÄMPFEREINBAULÄNGE
- ST** SHOCK TRAVEL
DÄMPFERHUB
- FF** FRONT FORK TRAVEL
FEDERWEG VORNE
- RF** REAR WHEEL TRAVEL
FEDERWEG HINTEN
- MS** MIN SADDLE HEIGHT
MIN SITTELHÖHE
- MX** MAX SADDLE HEIGHT
MAX SITTELHÖHE
- MI** MIN INSEAM
MIN SCHRITTLÄNGE
- MX** MAX INSEAM
MAX SCHRITTLÄNGE
- SL** STEM LENGTH
VORBAULÄNGE
- HW** HANDLEBAR WIDTH
LENKERBREITE
- CL** CRANK LENGTH
KURBELLENLÄNGE
- SM** SEATTUBE BOTTLE MOUNT
FLASCHE SITTELROHR
- DM** DOWNTUBE BOTTLE MOUNT
FLASCHE UNTERROHR

	STL	CSL	TTL	HTL	HTA	STA	BB	WB	ST	RE	SOH	HSD	AS	BS	SP	SH	SL	ST	FF	RF	MS	MX	MI	MX	SL	HW	CL	SM	DM	
KATO 9.9 / 7.9 / 6.9 AL U																														
S	420	445	595	110	70	73	65	1100	627	402	695	ZS44/ZS44	135/100	BSA68	31.6	/	/	/	100	/	75	720	175	0.5	0.75					
M	460	445	610	120	70	73	65	1115	637	415	730	ZS44/ZS44	135/100	BSA68	31.6	/	/	/	100	/	75	720	175	0.75	0.75					
L	500	445	620	130	70	73	65	1125	645	420	765	ZS44/ZS44	135/100	BSA68	31.6	/	/	/	100	/	90	720	175	0.75	0.75					
XL	540	445	630	140	70	73	65	1135	655	430	795	ZS44/ZS44	135/100	BSA68	31.6	/	/	/	100	/	90	720	175	0.75	0.75					
KATO 7.7 / 6.7 AL U																														
S	420	435	582	110	69	74	49	1100	592	411	695	ZS44/ZS44	135/100	BSA68	31.6	/	/	/	100	/	75	720	175	/	0.75					
M	460	435	597	120	69	74	49	1120	600	423	727	ZS44/ZS44	135/100	BSA68	31.6	/	/	/	100	/	75	720	175	0.75	0.75					
L	500	435	617	130	69	74	49	1140	612	441	759	ZS44/ZS44	135/100	BSA68	31.6	/	/	/	100	/	90	720	175	0.75	0.75					
KATO 5.9 / 2.9 AL U																														
S	420	445	585	110	70	73	66	1095	627	395	695	ZS44/ZS44	135/100	BSA68	31.6	/	/	/	100	/	75	720	175	/	0.75					
M	460	445	600	120	70	73	66	1110	637	405	725	ZS44/ZS44	135/100	BSA68	31.6	/	/	/	100	/	75	720	175	0.75	0.75					
L	500	445	610	130	70	73	66	1125	645	412	760	ZS44/ZS44	135/100	BSA68	31.6	/	/	/	100	/	90	720	175	0.75	0.75					
XL	540	445	620	140	70	73	66	1135	655	420	790	ZS44/ZS44	135/100	BSA68	31.6	/	/	/	100	/	90	720	175	0.75	0.75					
KATO 5.7 / 4.7 / 3.7 AL U																														
XS	380	435	570	100	69	74	47	1090	582	398	680	ZS44/ZS44	135/100	BSA68	31.6	/	/	/	100	/	60	720	170	/	0.75					
S	420	435	585	110	69	74	47	1100	592	411	695	ZS44/ZS44	135/100	BSA68	31.6	/	/	/	100	/	75	720	170	/	0.75					
M	460	435	600	120	69	74	47	1120	600	423	727	ZS44/ZS44	135/100	BSA68	31.6	/	/	/	100	/	75	720	170	0.75	0.75					
L	500	435	617	130	69	74	47	1140	610	440	756	ZS44/ZS44	135/100	BSA68	31.6	/	/	/	100	/	90	720	170	0.75	0.75					
KATO 4.9 / 3.9 AL U																														
S	420	445	585	110	70	73	66	1095	627	395	695	ZS44/ZS44	135/100	BSA68	31.6	/	/	/	100	/	75	720	170	/	0.75					
M	460	445	600	120	70	73	66	1110	637	405	725	ZS44/ZS44	135/100	BSA68	31.6	/	/	/	100	/	75	720	170	0.75	0.75					
L	500	445	610	130	70	73	66	1125	645	412	760	ZS44/ZS44	135/100	BSA68	31.6	/	/	/	100	/	90	720	170	0.75	0.75					
XL	540	445	620	140	70	73	66	1135	655	420	790	ZS44/ZS44	135/100	BSA68	31.6	/	/	/	100	/	90	720	170	0.75	0.75					
KATO 2.7 AL U																														
XXS	320	435	550	100	69	74	47	1070	582	384	645	ZS44/ZS44	135/100	BSA68	31.6	/	/	/	100	/	60	720	175	/	0.75					
XS	380	435	570	100	69	74	47	1090	582	398	680	ZS44/ZS44	135/100	BSA68	31.6	/	/	/	100	/	60	720	175	/	0.75					
S	420	435	585	110	69	74	47	1100	592	411	695	ZS44/ZS44	135/100	BSA68	31.6	/	/	/	100	/	75	720	175	/	0.75					
M	460	435	600	120	69	74	47	1120	600	423	727	ZS44/ZS44	135/100	BSA68	31.6	/	/	/	100	/	75	720	175	0.75	0.75					
L	500	435	617	130	69	74	47	1140	610	440	756	ZS44/ZS44	135/100	BSA68	31.6	/	/	/	100	/	90	720	175	0.75	0.75					
KATO 1.6 AL U																														
XXS	340	425	560	115	71	73.5	35	1040	575	390	610	ZS44/ZS44	135/100	BSA68	31.6	/	/	/	100	/	60	720	175	/	0.75					
XS	380	425	570	125	71	73.5	35	1050	585	395	650	ZS44/ZS44	135/100	BSA68	31.6	/	/	/	100	/	60	720	175	/	0.75					
S	420	425	580	135	71	73.5	35	1060	595	405	685	ZS44/ZS44	135/100	BSA68	31.6	/	/	/	100	/	75	720	175	/	0.75					
M	460	425	595	135	71	73.5	35	1070	595	415	700	ZS44/ZS44	135/100	BSA68	31.6	/	/	/	100	/	75	720	175	0.75	0.75					
L	500	425	603	135	71	73.5	35	1080	613	415	755	ZS44/ZS44	135/100	BSA68	31.6	/	/	/	100	/	90	720	175	0.75	0.75					



SHINY // night black / night black / neon red

29 AL **KATO** 9.9



MODEL HIGHLIGHTS

- ▶ Perfect mountain bike for touring
- ▶ 2x11 Shimano XT components
- ▶ Rock Shox suspension fork with remote

MODELL HIGHLIGHTS

- ▶ Idealer Tourer
- ▶ 2x11 Shimano XT Komponenten
- ▶ Rock Shox Federgabel mit Remote

KATO AL	Shimano XT FD-M8025	Continental X-King PureGrip 29x2.2 // Continental X-King PureGrip 29x2.2	Selle Italia X-Base
Rock Shox 30 Silver Poploc 100 mm	Shimano XT SL-M8000	Rodi Blackrock 622x21 mm 32H // Rodi Blackrock 622x21 mm 32H	16012
GHOST MTB Dia. 31.8 mm	Shimano XT FC-M8000 Hollowtech II 36-26	Shimano Deore HB-M6000 QR	BSA 68 mm
GHOST Low Rizer MTB 720 mm Rise 10 mm Dia. 31.8 mm	Shimano SLX CS-M7000 11-42	Shimano Deore FH-M6000 QR	E21954
Shimano XT RD-M8000 Shadow Plus 11-S	Shimano XT BR-M8000 2/2 Piston 180/160 mm Disc	GHOST Light DC 1 31.6 mm	S-M-L-XL

SIZE	ARTICLENUMBER	NOTES
SIZE S	18KA5037	
SIZE M	18KA5038	
SIZE L	18KA5039	
SIZE XL	18KA5040	



MODEL HIGHLIGHTS

- ▶ Shimano SLX/XT components
- ▶ Rock Shox suspension fork with remote
- ▶ Quality brand Selle Italia saddle

MODELL HIGHLIGHTS

- ▶ Shimano SLX/ XT Komponenten
- ▶ Rock Shox Federgabel mit Remote
- ▶ Selle Italia Markensattel

KATO AL	Shimano SLX FD-M7025	Continental X-King PureGrip 29x2.2 // Continental X-King PureGrip 29x2.2	Selle Italia X-Base
Rock Shox 30 Silver Poploc 100 mm	Shimano SLX SL-M7000	Rodi Blackrock 622x21 mm 32H // Rodi Blackrock 622x21 mm 32H	16358
GHOST MTB Dia. 31.8 mm	Shimano SLX FC-M7000 Hollowtech II 34-24	Shimano HB-RM35 QR	BSA 68 mm
GHOST Low Rizer MTB 720 mm Rise 10 mm Dia. 31.8 mm	Shimano SLX CS-M7000 11-42	Shimano FH-RM35 QR	EZ1954
Shimano XT RD-M8000 Shadow Plus 11-S	Shimano BR-M315 2/2 Piston 180/160 mm Disc	GHOST Light DC 1 31.6 mm	S-M-L-XL

SIZE	ARTICLENUMBER	NOTES
SIZE S	18KA5013	
SIZE M	18KA5014	
SIZE L	18KA5015	
SIZE XL	18KA5016	



SHINY // microchip gray / neon yellow

29 AL **KATO** 7.9



MODEL HIGHLIGHTS

- ▶ Shimano SLX/XT components
- ▶ Rock Shox suspension fork with remote
- ▶ Quality brand Selle Italia saddle

MODELL HIGHLIGHTS

- ▶ Shimano SLX/ XT Komponenten
- ▶ Rock Shox Federgabel mit Remote
- ▶ Selle Italia Markensattel

KATO AL	Shimano SLX FD-M7025	Continental X-King PureGrip 29x2.2 // Continental X-King PureGrip 29x2.2	Selle Italia X-Base
Rock Shox 30 Silver Poploc 100 mm	Shimano SLX SL-M7000	Rudi Blackrock 622x21 mm 32H // Rudi Blackrock 622x21 mm 32H	14358
GHOST MTB Dia. 31.8 mm	Shimano SLX FC-M7000 Hollowtech II 34-24	Shimano HB-RM35 QR	BSA 68 mm
GHOST Low Rizer MTB 720 mm Rise 10 mm Dia. 31.8 mm	Shimano SLX CS-M7000 11-42	Shimano FH-RM35 QR	EZ1954
Shimano XT RD-M8000 Shadow Plus 11-S	Shimano BR-M315 2/2 Piston 180/160 mm Disc	GHOST Light DC 1 31.6 mm	S-M-L-XL

SIZE	ARTICLENUMBER	NOTES
SIZE S	18KA5019	
SIZE M	18KA5020	
SIZE L	18KA5021	
SIZE XL	18KA5022	



MODEL HIGHLIGHTS

- ▶ Shimano SLX/XT components
- ▶ Rock Shox suspension fork with remote
- ▶ Quality brand Selle Italia saddle

MODELL HIGHLIGHTS

- ▶ Shimano SLX/ XT Komponenten
- ▶ Rock Shox Federgabel mit Remote
- ▶ Selle Italia Markensattel

KATO AL	Shimano SLX FD-M7025	Continental X-King PureGrip 27.5x2.2 // Continental X-King PureGrip 27.5x2.2	Selle Italia X-Base
Rock Shox 30 Silver Poploc 100 mm	Shimano SLX SL-M7000	Rodi Blackrock 584x21 mm 32H // Rodi Blackrock 584x21 mm 32H	16358
GHOSH MTB Dia. 31.8 mm	Shimano SLX FC-M7000 Hollowtech II 34-24	Shimano HB-RM35 QR	BSA 68 mm
GHOSH Low Rizer MTB 720 mm Rise 10 mm Dia. 31.8 mm	Shimano SLX CS-M7000 11-42	Shimano FH-RM35 QR	E21954
Shimano XT RD-M8000 Shadow Plus 11-S	Shimano BR-M315 2/2 Piston 180/160 mm Disc	GHOSH Light DC 1.31.6 mm	S-M-L

SIZE	ARTICLENUMBER	NOTES
SIZE S	18KA3014	
SIZE M	18KA3015	
SIZE L	18KA3016	



SHINY // microchip gray / neon yellow

27.5 AL **KATO 7.7**



MODEL HIGHLIGHTS

- ▶ Shimano SLX/XT components
- ▶ Rock Shox suspension fork with remote
- ▶ Quality brand Selle Italia saddle

MODELL HIGHLIGHTS

- ▶ Shimano SLX/ XT Komponenten
- ▶ Rock Shox Federgabel mit Remote
- ▶ Selle Italia Markensattel

KATO AL	Shimano SLX FD-M7025	Continental X-King PureGrip 27.5x2.2 // Continental X-King PureGrip 27.5x2.2	Selle Italia X-Base
Rock Shox 30 Silver Poploc 100 mm	Shimano SLX SL-M7000	Rudi Blackrock 584x21 mm 32H // Rudi Blackrock 584x21 mm 32H	14358
GHOST MTB Dia. 31.8 mm	Shimano SLX FC-M7000 Hollowtech II 34-24	Shimano HB-RM35 QR	BSA 68 mm
GHOST Low Rizer MTB 720 mm Rise 10 mm Dia. 31.8 mm	Shimano SLX CS-M7000 11-42	Shimano FH-RM35 QR	E21954
Shimano XT RD-M8000 Shadow Plus 11-S	Shimano BR-M315 2/2 Piston 180/160 mm Disc	GHOST Light DC 1 31.6 mm	S-M-L

SIZE	ARTICLENUMBER	NOTES
SIZE S	18KA3020	
SIZE M	18KA3021	
SIZE L	18KA3022	



MODEL HIGHLIGHTS

- ▶ Lightweight Shimano Deore HT2 crankset
- ▶ 3x10 Deore drivetrain with Shadow Plus
- ▶ Lightweight Suntour EPIXON air suspension fork

MODELL HIGHLIGHTS

- ▶ Leichte Shimano Deore HT2 Kurbel
- ▶ 3x10 Deore Schaltung mit Shadow Plus
- ▶ Leichte Suntour EPIXON Luftgabel

KATO AL	Shimano Deore FD-M6000 Side Swing	Continental X-King PureGrip 29x2.2 // Continental X-King PureGrip 29x2.2	Selle Italia X-Base
SR Suntour EPIXON RLR 100 mm	Shimano Deore SL-M6000	Rodi Excalibur XC 622x19 mm 32H // Rodi Excalibur XC 622x19 mm 32H	16358
GHOST MTB Dia. 31.8 mm	Shimano Deore FC-M6000 Hollowtech II 40-30-22	Shimano HB-RM35 QR	BSA 68 mm
GHOST Low Rizer MTB 720 mm Rise 10 mm Dia. 31.8 mm	Shimano CS-HG50-10 11-36	Shimano FH-RM35 QR	EZ1954
Shimano Deore RD-M6000 Shadow Plus 10-S	Shimano BR-M315 2/2 Piston 160 mm Disc	GHOST Light DC 1 31.6 mm	S-M-L-XL

SIZE	ARTICLENUMBER	NOTES
SIZE S	18KA5001	
SIZE M	18KA5002	
SIZE L	18KA5003	
SIZE XL	18KA5004	



SHINY // night black / titanium gray / neon red

29 AL **KATO** 6.9



MODEL HIGHLIGHTS

- ▶ Lightweight Shimano Deore HT2 crankset
- ▶ 3x10 Deore drivetrain with Shadow Plus
- ▶ Lightweight Suntour EPIXON air suspension fork

MODELL HIGHLIGHTS

- ▶ Leichte Shimano Deore HT2 Kurbel
- ▶ 3x10 Deore Schaltung mit Shadow Plus
- ▶ Leichte Suntour EPIXON Luftgabel

KATO AL	Shimano Deore FD-M6000 Side Swing	Continental X-King PureGrip 29x2.2 // Continental X-King PureGrip 29x2.2	Selle Italia X-Base
SR Suntour EPIXON RLR 100 mm	Shimano Deore SL-M6000	Rodi Excalibur XC 622x19 mm 32H // Rodi Excalibur XC 622x19 mm 32H	14358
GHOST MTB Dia. 31.8 mm	Shimano Deore FC-M6000 Hollowtech II 40-30-22	Shimano HB-RM35 QR	BSA 68 mm
GHOST Low Rizer MTB 720 mm Rise 10 mm Dia. 31.8 mm	Shimano CS-HG50-10 11-36	Shimano FH-RM35 QR	EZ1954
Shimano Deore RD-M6000 Shadow Plus 10-S	Shimano BR-M315 2/2 Piston 160 mm Disc	GHOST Light DC 1 31.6 mm	S-M-L-XL

SIZE	ARTICLENUMBER	NOTES
SIZE S	18KA5007	
SIZE M	18KA5008	
SIZE L	18KA5009	
SIZE XL	18KA5010	



MODEL HIGHLIGHTS

- ▶ Lightweight Shimano Deore HT2 crankset
- ▶ 3x10 Deore drivetrain with Shadow Plus
- ▶ Lightweight Suntour EPIXON air suspension fork

MODELL HIGHLIGHTS

- ▶ Leichte Shimano Deore HT2 Kurbel
- ▶ 3x10 Deore Schaltung mit Shadow Plus
- ▶ Leichte Suntour EPIXON Luftgabel

KATO AL	Shimano Deore FD-M6000 Side Swing	Continental X-King PureGrip 27.5x2.2 // Continental X-King PureGrip 27.5x2.2	Selle Italia X-Base
SR Suntour EPIXON RLR 100 mm	Shimano Deore SL-M6000	Rodi Excalibur XC 584x19 mm 32H // Rodi Excalibur XC 584x19 mm 32H	16358
GHOST MTB Dia. 31.8 mm	Shimano Deore FC-M6000 Hollowtech II 40-30-22	Shimano HB-RM35 QR	BSA 68 mm
GHOST Low Rizer MTB 720 mm Rise 10 mm Dia. 31.8 mm	Shimano CS-HG50-10 11-36	Shimano FH-RM35 QR	EZ1954
Shimano Deore RD-M6000 Shadow Plus 10-S	Shimano BR-M315 2/2 Piston 160 mm Disc	GHOST Light DC 1 31.6 mm	S-M-L

SIZE	ARTICLENUMBER	NOTES
SIZE S	18KA3002	
SIZE M	18KA3003	
SIZE L	18KA3004	



SHINY // night black / titanium gray / neon red

27.5 AL **KATO** 6.7



MODEL HIGHLIGHTS

- ▶ Lightweight Shimano Deore HT2 crankset
- ▶ 3x10 Deore drivetrain with Shadow Plus
- ▶ Lightweight Suntour EPIXON air suspension fork

MODELL HIGHLIGHTS

- ▶ Leichte Shimano Deore HT2 Kurbel
- ▶ 3x10 Deore Schaltung mit Shadow Plus
- ▶ Leichte Suntour EPIXON Luftgabel

KATO AL	Shimano Deore FD-M6000 Side Swing	Continental X-King PureGrip 27.5x2.2 // Continental X-King PureGrip 27.5x2.2	Selle Italia X-Base
SR Suntour EPIXON RLR 100 mm	Shimano Deore SL-M6000	Rodi Excalibur XC 584x19 mm 32H // Rodi Excalibur XC 584x19 mm 32H	14358
GHOST MTB Dia. 31.8 mm	Shimano Deore FC-M6000 Hollowtech II 40-30-22	Shimano HB-RM35 OR	BSA 68 mm
GHOST Low Rizer MTB 720 mm Rise 10 mm Dia. 31.8 mm	Shimano CS-HG50-10 11-36	Shimano FH-RM35 OR	EZ1954
Shimano Deore RD-M6000 Shadow Plus 10-S	Shimano BR-M315 2/2 Piston 160 mm Disc	GHOST Light DC 1 31.6 mm	S-M-L

SIZE	ARTICLENUMBER	NOTES
SIZE S	18KA3008	
SIZE M	18KA3009	
SIZE L	18KA3010	



MODEL HIGHLIGHTS

- ▶ Great price / performance ratio
- ▶ Rock Shox suspension fork
- ▶ Shimano XT rear derailleur

MODELL HIGHLIGHTS

- ▶ Tolles Preis-/ Leistungs-Verhältnis
- ▶ Rock Shox Federgabel
- ▶ Shimano XT Schaltwerk

KATO AL	Shimano Acera FD-M3000	Continental X-King PureGrip 29x2.2 // Continental X-King PureGrip 29x2.2	Selle Italia X-Base
Rock Shox 30 Silver Poploc 100 mm	Shimano Alivio SL-M4000	Rodi Excalibur XC 622x19 mm 32H // Rodi Excalibur XC 622x19 mm 32H	14106
GHOST MTB Dia. 31.8 mm	Shimano FC-M4000 40-30-22	Shimano HB-RM35 QR	BSA 68 mm
GHOST Low Rizer MTB 720 mm Rise 10 mm Dia. 31.8 mm	Shimano CS-HG-200-9 11-34	Shimano FH-RM35 QR	EZ1954
Shimano XT RD-M772 9-S	Shimano BR-M315 2/2 Piston 160 mm Disc	GHOST Light DC 1 31.6 mm	S-M-L-XL

SIZE	ARTICLENUMBER	NOTES
SIZE S	18KA4037	
SIZE M	18KA4038	
SIZE L	18KA4039	
SIZE XL	18KA4040	



SHINY // night black / night black / electric blue

29 AL **KATO** 5.9



MODEL HIGHLIGHTS

- ▶ Great price / performance ratio
- ▶ Rock Shox suspension fork
- ▶ Shimano XT rear derailleurs

MODELL HIGHLIGHTS

- ▶ Tolles Preis-/ Leistungs-Verhältnis
- ▶ Rock Shox Federgabel
- ▶ Shimano XT Schaltwerk

KATO AL	Shimano Acera FD-M3000	Continental X-King PureGrip 29x2.2 // Continental X-King PureGrip 29x2.2	Selle Italia X-Base
Rock Shox 30 Silver Poploc 100 mm	Shimano Alivio SL-M4000	Rodi Excalibur XC 622x19 mm 32H // Rodi Excalibur XC 622x19 mm 32H	14106
GHOST MTB Dia. 31.8 mm	Shimano FC-M4000 40-30-22	Shimano HB-RM35 QR	BSA 68 mm
GHOST Low Rizer MTB 720 mm Rise 10 mm Dia. 31.8 mm	Shimano CS-HG-200-9 11-34	Shimano FH-RM35 QR	EZ1954
Shimano XT RD-M772 9-S	Shimano BR-M315 2/2 Piston 160 mm Disc	GHOST Light DC 1 31.6 mm	S-M-L-XL

SIZE	ARTICLENUMBER	NOTES
SIZE S	18KA0043	
SIZE M	18KA0044	
SIZE L	18KA0045	
SIZE XL	18KA0046	



MODEL HIGHLIGHTS

- ▶ Great price / performance ratio
- ▶ Rock Shox suspension fork
- ▶ Shimano XT rear derailleur

MODELL HIGHLIGHTS

- ▶ Tolles Preis-/ Leistungs-Verhältnis
- ▶ Rock Shox Federgabel
- ▶ Shimano XT Schaltwerk

KATO AL	Shimano Acera FD-M3000	Continental X-King PureGrip 27.5x2.2 // Continental X-King PureGrip 27.5x2.2	Selle Italia X-Base
Rock Shox 30 Silver Poploc 100 mm	Shimano Alivio SL-M4000	Rodi Excalibur XC 584x19 mm 32H // Rodi Excalibur XC 584x19 mm 32H	14106
GHOST MTB Dia. 31.8 mm	Shimano FC-M4000 40-30-22	Shimano HB-RM35 QR	BSA 68 mm
GHOST Low Rizer MTB 720 mm Rise 10 mm Dia. 31.8 mm	Shimano CS-HG-200-9 11-34	Shimano FH-RM35 QR	EZ1954
Shimano XT RD-M772 9-S	Shimano BR-M315 2/2 Piston 160 mm Disc	GHOST Light DC 1 31.6 mm	S-M-L

SIZE	ARTICLENUMBER	NOTES
SIZE S	18KA2039	
SIZE M	18KA2040	
SIZE L	18KA2041	



SHINY // night black / night black / electric blue

27.5 AL **KATO** 5.7



MODEL HIGHLIGHTS

- ▶ Great price / performance ratio
- ▶ Rock Shox suspension fork
- ▶ Shimano XT rear derailleur

MODELL HIGHLIGHTS

- ▶ Tolles Preis-/ Leistungs-Verhältnis
- ▶ Rock Shox Federgabel
- ▶ Shimano XT Schaltwerk

KATO AL	Shimano Acera FD-M3000	Continental X-King PureGrip 27.5x2.2 // Continental X-King PureGrip 27.5x2.2	Selle Italia X-Base
Rock Shox 30 Silver Poploc 100 mm	Shimano Alivio SL-M4000	Rodi Excalibur XC 584x19 mm 32H // Rodi Excalibur XC 584x19 mm 32H	14106
GHOST MTB Dia. 31.8 mm	Shimano FC-M4000 40-30-22	Shimano HB-RM35 QR	BSA 68 mm
GHOST Low Rizer MTB 720 mm Rise 10 mm Dia. 31.8 mm	Shimano CS-HG-200-9 11-34	Shimano FH-RM35 QR	EZ1954
Shimano XT RD-M772 9-S	Shimano BR-M315 2/2 Piston 160 mm Disc	GHOST Light DC 1 31.6 mm	S-M-L

SIZE	ARTICLENUMBER	NOTES
SIZE S	18KA2044	
SIZE M	18KA2045	
SIZE L	18KA2046	



MODEL HIGHLIGHTS

- ▶ Quality brand Selle Italia saddle
- ▶ Equipped with Continental quality tires
- ▶ Shimano Deore rear derailleur

MODELL HIGHLIGHTS

- ▶ Selle Italia Markensattel
- ▶ Continental Markenbereifung
- ▶ Shimano Deore Schaltwerk

KATO AL	Shimano Altus FD-M370	Continental X-King PureGrip 29x2.2 // Continental X-King PureGrip 29x2.2	Selle Italia X-Base
SR Suntour XCM RL 100 mm	Shimano Altus SL-M2000	Rodi Excalibur XC 622x19 mm 32H // Rodi Excalibur XC 622x19 mm 32H	14106
GHOST MTB Dia. 31.8 mm	Shimano FC-M371 44-32-22	Shimano HB-RM35 QR	BSA 68 mm
GHOST Low Rizer MTB 720 mm Rise 10 mm Dia. 31.8 mm	Shimano CS-HG-200-9 11-34	Shimano FH-RM35 QR	EZ1954
Shimano Deore RD-M592 9-S	Shimano BR-M315 2/2 Piston 160 mm Disc	GHOST Light DC 1 31.6 mm	S-M-L-XL

SIZE	ARTICLENUMBER	NOTES
SIZE S	18KA4025	
SIZE M	18KA4026	
SIZE L	18KA4027	
SIZE XL	18KA4028	



SHINY // night black / night black / neon green

29 AL **KATO** 4.9



MODEL HIGHLIGHTS

- ▶ Quality brand Selle Italia saddle
- ▶ Equipped with Continental quality tires
- ▶ Shimano Deore rear derailleur

MODELL HIGHLIGHTS

- ▶ Selle Italia Markensattel
- ▶ Continental Markenbereifung
- ▶ Shimano Deore Schaltwerk

KATO AL	Shimano Altus FD-M370	Continental X-King PureGrip 29x2.2 // Continental X-King PureGrip 29x2.2	Selle Italia X-Base
SR Suntour XCM RL 100 mm	Shimano Altus SL-M2000	Rodi Excalibur XC 622x19 mm 32H // Rodi Excalibur XC 622x19 mm 32H	14106
GHOST MTB Dia. 31.8 mm	Shimano FC-M371 44-32-22	Shimano HB-RM35 QR	BSA 68 mm
GHOST Low Rizer MTB 720 mm Rise 10 mm Dia. 31.8 mm	Shimano CS-HG-200-9 11-34	Shimano FH-RM35 QR	EZ1954
Shimano Deore RD-M592 9-S	Shimano BR-M315 2/2 Piston 160 mm Disc	GHOST Light DC 1 31.6 mm	S-M-L-XL

SIZE	ARTICLENUMBER	NOTES
SIZE S	18KA4031	
SIZE M	18KA4032	
SIZE L	18KA4033	
SIZE XL	18KA4034	



MODEL HIGHLIGHTS

- ▶ Quality brand Selle Italia saddle
- ▶ Equipped with Continental quality tires
- ▶ Shimano Deore rear derailleur

MODELL HIGHLIGHTS

- ▶ Selle Italia Markensattel
- ▶ Continental Markenbereifung
- ▶ Shimano Deore Schaltwerk

KATO AL	Shimano Altus FD-M370	Continental X-King PureGrip 27.5x2.2 // Continental X-King PureGrip 27.5x2.2	Selle Italia X-Base
SR Suntour XCM RL 100 mm	Shimano Altus SL-M2000	Rodi Excalibur XC 584x19 mm 32H // Rodi Excalibur XC 584x19 mm 32H	14106
GHOST MTB Dia. 31.8 mm	Shimano FC-M371 44-32-22	Shimano HB-RM35 QR	BSA 68 mm
GHOST Low Rizer MTB 720 mm Rise 10 mm Dia. 31.8 mm	Shimano CS-HG-200-9 11-34	Shimano FH-RM35 QR	EZ1954
Shimano Deore RD-M592 9-S	Shimano BR-M315 2/2 Piston 160 mm Disc	GHOST Light DC 1 31.6 mm	XS-S-M-L

SIZE	ARTICLENUMBER	NOTES
SIZE XS	18KA2027	
SIZE S	18KA2028	
SIZE M	18KA2029	
SIZE L	18KA2030	



SHINY // night black / night black / neon green

27.5 AL **KATO** 4.7



MODEL HIGHLIGHTS

- ▶ Quality brand Selle Italia saddle
- ▶ Equipped with Continental quality tires
- ▶ Shimano Deore rear derailleur

MODELL HIGHLIGHTS

- ▶ Selle Italia Markensattel
- ▶ Continental Markenbereifung
- ▶ Shimano Deore Schaltwerk

KATO AL	Shimano Altus FD-M370	Continental X-King PureGrip 27.5x2.2 // Continental X-King PureGrip 27.5x2.2	Selle Italia X-Base
SR Suntour XCM RL 100 mm	Shimano Altus SL-M2000	Rodi Excalibur XC 584x19 mm 32H // Rodi Excalibur XC 584x19 mm 32H	14106
GHOST MTB Dia. 31.8 mm	Shimano FC-M371 44-32-22	Shimano HB-RM35 QR	BSA 68 mm
GHOST Low Rizer MTB 720 mm Rise 10 mm Dia. 31.8 mm	Shimano CS-HG-200-9 11-34	Shimano FH-RM35 QR	EZ1954
Shimano Deore RD-M592 9-S	Shimano BR-M315 2/2 Piston 160 mm Disc	GHOST Light DC 1 31.6 mm	XS-S-M-L

SIZE	ARTICLENUMBER	NOTES
SIZE XS	18KA2033	
SIZE S	18KA2034	
SIZE M	18KA2035	
SIZE L	18KA2036	



MODEL HIGHLIGHTS

- ▶ Shimano Acera 3x8 drivetrain
- ▶ Hydraulic Shimano disc brakes
- ▶ Quality brand Selle Italia saddle

MODELL HIGHLIGHTS

- ▶ Shimano Acera 3x8-Antrieb
- ▶ Hydraulische Shimano Scheibenbremsen
- ▶ Selle Italia Markensattel

KATO AL	Shimano Tourney FD-TY700-TS6	Michelin Country Race R 29x2.10 // Michelin Country Race R 29x2.10	Selle Italia X-Base
RST Blaze RL 100 mm	Shimano SL-M310	Rodi Excalibur XC 622x19 mm 32H // Rodi Excalibur XC 622x19 mm 32H	14106
GHOST MTB Dia. 31.8 mm	Shimano FC-TY501 42-34-24	Shimano HB-RM35 QR	BSA 68 mm
GHOST Low Rizer MTB 720 mm Rise 10 mm Dia. 31.8 mm	Shimano CS-HG-200-8 12-32	Shimano FH-RM35 QR	EZ1954
Shimano Acera RD-M360 8-S	Shimano BR-M315 2/2 Piston 160 mm Disc	GHOST Light DC 1 31.6 mm	S-M-L-XL

SIZE	ARTICLENUMBER	NOTES
SIZE S	18KA4013	
SIZE M	18KA4014	
SIZE L	18KA4015	
SIZE XL	18KA4016	



SHINY // night black / night black / neon yellow

29 AL **KATO** 3.9



MODEL HIGHLIGHTS

- ▶ Shimano Acera 3x8 drivetrain
- ▶ Hydraulic Shimano disc brakes
- ▶ Quality brand Selle Italia saddle

MODELL HIGHLIGHTS

- ▶ Shimano Acera 3x8-Antrieb
- ▶ Hydraulische Shimano Scheibenbremsen
- ▶ Selle Italia Markensattel

KATO AL	Shimano Tourney FD-TY700-TS6	Michelin Country Race R 29x2.10 // Michelin Country Race R 29x2.10	Selle Italia X-Base
RST Blaze RL 100 mm	Shimano SL-M310	Rodi Excalibur XC 622x19 mm 32H // Rodi Excalibur XC 622x19 mm 32H	14106
GHOST MTB Dia. 31.8 mm	Shimano FC-TY501 42-34-24	Shimano HB-RM35 QR	BSA 68 mm
GHOST Low Rizer MTB 720 mm Rise 10 mm Dia. 31.8 mm	Shimano CS-HG-200-8 12-32	Shimano FH-RM35 QR	EZ1954
Shimano Acera RD-M360 8-S	Shimano BR-M315 2/2 Piston 160 mm Disc	GHOST Light DC 1 31.6 mm	S-M-L-XL

SIZE	ARTICLENUMBER	NOTES
SIZE S	18KA4019	
SIZE M	18KA4020	
SIZE L	18KA4021	
SIZE XL	18KA4022	



MODEL HIGHLIGHTS

- ▶ Shimano Acera 3x8 drivetrain
- ▶ Hydraulic Shimano disc brakes
- ▶ Quality brand Selle Italia saddle

MODELL HIGHLIGHTS

- ▶ Shimano Acera 3x8-Antrieb
- ▶ Hydraulische Shimano Scheibenbremsen
- ▶ Selle Italia Markensattel

KATO AL	Shimano Tourney FD-TY700-TS6	Michelin Country Race R 27.5x2.10 // Michelin Country Race R 27.5x2.10	Selle Italia X-Base
RST Blaze RL 100 mm	Shimano SL-M310	Rodi Excalibur XC 584x19 mm 32H // Rodi Excalibur XC 584x19 mm 32H	14106
GHOST MTB Dia. 31.8 mm	Shimano FC-TY501 42-34-24	Shimano HB-RM35 QR	BSA 68 mm
GHOST Low Rizer MTB 720 mm Rise 10 mm Dia. 31.8 mm	Shimano CS-HG-200-8 12-32	Shimano FH-RM35 QR	EZ1954
Shimano Acera RD-M360 8-S	Shimano BR-M315 2/2 Piston 160 mm Disc	GHOST Light DC 1 31.6 mm	XS-S-M-L

SIZE	ARTICLENUMBER	NOTES
SIZE XS	18KA2015	
SIZE S	18KA2016	
SIZE M	18KA2017	
SIZE L	18KA2018	



SHINY // night black / night black / neon yellow

27.5 AL **KATO** 3.7



MODEL HIGHLIGHTS

- ▶ Shimano Acera 3x8 drivetrain
- ▶ Hydraulic Shimano disc brakes
- ▶ Quality brand Selle Italia saddle

MODELL HIGHLIGHTS

- ▶ Shimano Acera 3x8-Antrieb
- ▶ Hydraulische Shimano Scheibenbremsen
- ▶ Selle Italia Markensattel

KATO AL	Shimano Tourney FD-TY700-TS6	Michelin Country Race R 27.5x2.10 // Michelin Country Race R 27.5x2.10	Selle Italia X-Base
RST Blaze RL 100 mm	Shimano SL-M310	Rodi Excalibur XC 584x19 mm 32H // Rodi Excalibur XC 584x19 mm 32H	14106
GHOST MTB Dia. 31.8 mm	Shimano FC-TY501 42-34-24	Shimano HB-RM35 QR	BSA 68 mm
GHOST Low Rizer MTB 720 mm Rise 10 mm Dia. 31.8 mm	Shimano CS-HG-200-8 12-32	Shimano FH-RM35 QR	EZ1954
Shimano Acera RD-M360 8-S	Shimano BR-M315 2/2 Piston 160 mm Disc	GHOST Light DC 1 31.6 mm	XS-S-M-L

SIZE	ARTICLENUMBER	NOTES
SIZE XS	18KA2021	
SIZE S	18KA2022	
SIZE M	18KA2023	
SIZE L	18KA2024	



MODEL HIGHLIGHTS

- ▶ Shimano Acera 3x8 drivetrain
- ▶ Hydraulic disc brakes
- ▶ Quality brand Selle Italia saddle

MODELL HIGHLIGHTS

- ▶ Shimano Acera 3x8-Antrieb
- ▶ Hydraulische Scheibenbremsen
- ▶ Selle Italia Markensattel

KATO AL	Shimano Tourney FD-TY700-TS6	Michelin Country Race R 29x2.10 // Michelin Country Race R 29x2.10	Selle Italia X-Base
RST Blaze MLO 100 mm	Shimano SL-M310	Rodi Excalibur XC 622x19 mm 32H // Rodi Excalibur XC 622x19 mm 32H	14106
GHOST MTB Dia. 31.8 mm	Shimano FC-TY301 42-34-24	Formula DC 20 OR	BSA 68 mm
GHOST Low Rizer MTB 720 mm Rise 10 mm Dia. 31.8 mm	Shimano CS-HG-200-8 12-32	Formula DC 22 OR	EZ1954
Shimano Acera RD-M360 8-S	Tektro HD-M285 2/2 Piston 160 mm Disc	GHOST Light DC 1 31.6 mm	S-M-L-XL

SIZE	ARTICLENUMBER	NOTES
SIZE S	18KA4001	
SIZE M	18KA4002	
SIZE L	18KA4003	
SIZE XL	18KA4004	



SHINY // night black / night black / neon red

29 AL **KATO** 2.9



MODEL HIGHLIGHTS

- ▶ Shimano Acera 3x8 drivetrain
- ▶ Hydraulic disc brakes
- ▶ Quality brand Selle Italia saddle

MODELL HIGHLIGHTS

- ▶ Shimano Acera 3x8-Antrieb
- ▶ Hydraulische Scheibenbremsen
- ▶ Selle Italia Markensattel

KATO AL	Shimano Tourney FD-TY700-TS6	Michelin Country Race R 29x2.10 // Michelin Country Race R 29x2.10	Selle Italia X-Base
RST Blaze MLO 100 mm	Shimano SL-M310	Rodi Excalibur XC 622x19 mm 32H // Rodi Excalibur XC 622x19 mm 32H	14106
GHOST MTB Dia. 31.8 mm	Shimano FC-TY301 42-34-24	Formula DC 20 QR	BSA 68 mm
GHOST Low Rizer MTB 720 mm Rise 10 mm Dia. 31.8 mm	Shimano CS-HG-200-8 12-32	Formula DC 22 QR	EZ1954
Shimano Acera RD-M360 8-S	Tektro HD-M285 2/2 Piston 160 mm Disc	GHOST Light DC 1 31.6 mm	S-M-L-XL

SIZE	ARTICLENUMBER	NOTES
SIZE S	18KA4007	
SIZE M	18KA4008	
SIZE L	18KA4009	
SIZE XL	18KA4010	



MODEL HIGHLIGHTS

- ▶ Shimano Acera 3x8 drivetrain
- ▶ Hydraulic disc brakes
- ▶ Quality brand Selle Italia saddle

MODELL HIGHLIGHTS

- ▶ Shimano Acera 3x8-Antrieb
- ▶ Hydraulische Scheibenbremsen
- ▶ Selle Italia Markensattel

KATO AL	Shimano Tourney FD-TY700-TS6	Michelin Country Race R 27.5x2.10 // Michelin Country Race R 27.5x2.10	Selle Italia X-Base
RST Blaze MLO 100 mm	Shimano SL-M310	Rodi Excalibur XC 584x19 mm 32H // Rodi Excalibur XC 584x19 mm 32H	1.4106
GHOST MTB Dia. 31.8 mm	Shimano FC-TY301 42-34-24	Formula DC 20 OR	BSA 68 mm
GHOST Low Rizer MTB 720 mm Rise 10 mm Dia. 31.8 mm	Shimano CS-HG-200-8 12-32	Formula DC 22 OR	EZ1954
Shimano Acera RD-M360 8-S	Tektro HD-M285 2/2 Piston 160 mm Disc	GHOST Light DC 1.31.6 mm	XXS-XS-S-M-L

SIZE	ARTICLENUMBER	NOTES
SIZE XXS	18KA2001	
SIZE XS	18KA2002	
SIZE S	18KA2003	
SIZE M	18KA2004	
SIZE L	18KA2005	



SHINY // night black / night black / neon red

27.5 AL **KATO** 2.7



MODEL HIGHLIGHTS

- ▶ Shimano Acera 3x8 drivetrain
- ▶ Hydraulic disc brakes
- ▶ Quality brand Selle Italia saddle

MODELL HIGHLIGHTS

- ▶ Shimano Acera 3x8-Antrieb
- ▶ Hydraulische Scheibenbremsen
- ▶ Selle Italia Markensattel

KATO AL	Shimano Tourney FD-TY700-TS6	Michelin Country Race R 27.5x2.10 // Michelin Country Race R 27.5x2.10	Selle Italia X-Base
RST Blaze MLO 100 mm	Shimano SL-M310	Rodi Excalibur XC 584x19 mm 32H // Rodi Excalibur XC 584x19 mm 32H	14106
GHOST MTB Dia. 31.8 mm	Shimano FC-TY301 42-34-24	Formula DC 20 QR	BSA 68 mm
GHOST Low Rizer MTB 720 mm Rise 10 mm Dia. 31.8 mm	Shimano CS-HG-200-8 12-32	Formula DC 22 QR	EZ1954
Shimano Acera RD-M360 8-S	Tektro HD-M285 2/2 Piston 160 mm Disc	GHOST Light DC 1 31.6 mm	XXS-XS-S-M-L

SIZE	ARTICLENUMBER	NOTES
SIZE XXS	18KA2008	
SIZE XS	18KA2009	
SIZE S	18KA2010	
SIZE M	18KA2011	
SIZE L	18KA2012	



MODEL HIGHLIGHTS

- ▶ For students and youngsters
- ▶ With disc brakes and suspension fork

MODELL HIGHLIGHTS

- ▶ Für Schüler und Jugendliche
- ▶ Mit Scheibenbremsen und Federgabel

KATO AL	Shimano Tourney FD-TY700-TS6	Michelin Country Race R 26x2.10 // Michelin Country Race R 26x2.10	Selle Italia X-Base
RST GILAT 100 mm	Shimano Tourney ST-TX800	Alex TD 26 559x20 mm 32H // Alex TD 26 559x20 mm 32H	14106
GHOST MTB Dia. 31.8 mm	Shimano FC-TY301 42-34-24	Shimano HB-TX505 OR	BSA 68 mm
GHOST Low Rizer MTB 700 mm Rise 10 mm Dia. 31.8 mm	Shimano CS-HG-200-8 12-32	Shimano FH-RM33 OR	EZ2036
Shimano Tourney TX RD-TX800 8-S	Shimano mech. Disc BR-M375 2/2 Piston 160 mm Disc	GHOST Light DC 1 31.6 mm	XXS-XS-S-M-L

SIZE	ARTICLENUMBER	NOTES
SIZE XXS	18KA1001	
SIZE XS	18KA1002	
SIZE S	18KA1003	
SIZE M	18KA1004	
SIZE L	18KA1005	



SHINY // night black / night black / vibrant blue

26 AL **KATO** 1.6



MODEL HIGHLIGHTS

- ▶ For students and youngsters
- ▶ With disc brakes and suspension fork

MODELL HIGHLIGHTS

- ▶ Für Schüler und Jugendliche
- ▶ Mit Scheibenbremsen und Federgabel

KATO AL	Shimano Tourney FD-TY700-TS6	Michelin Country Race R 26x2.10 // Michelin Country Race R 26x2.10	Selle Italia X-Base
RST GILA T 100 mm	Shimano Tourney ST-TX800	Alex TD 26 559x20 mm 32H // Alex TD 26 559x20 mm 32H	14106
GHOST MTB Dia. 31.8 mm	Shimano FC-TY301 42-34-24	Shimano HB-TX505 OR	BSA 68 mm
GHOST Low Rizer MTB 700 mm Rise 10 mm Dia. 31.8 mm	Shimano CS-HG-200-8 12-32	Shimano FH-RM33 OR	EZ2036
Shimano Tourney TX RD-TX800 8-S	Shimano mech. Disc BR-M375 2/2 Piston 160 mm Disc	GHOST Light DC 1 31.6 mm	XXS-XS-S-M-L

SIZE	ARTICLENUMBER	NOTES
SIZE XXS	18KA1008	
SIZE XS	18KA1009	
SIZE S	18KA1010	
SIZE M	18KA1011	
SIZE L	18KA1012	



// ALLROUND / TOUR

FEATURES



CHARACTERISTICS

- ▶ The LANAo FS geometry offers playful handling
- ▶ The plush AMR four-bar-linkage chassis guarantees the successful split between efficiency and gulping suspension performance
- ▶ Tour-specific equipment options guarantee comfort even on long tours
- ▶ Women specific components guarantee ergonomically correct contact with the bike

CHARAKTERISTIK

- ▶ Die LANAo FS-Geometrie bietet ein spielerisches Handling
- ▶ Dem satten AMR-Viergelenkfahrwerk gelingt der Spagat zwischen Effizienz und Schluckfreudigkeit
- ▶ Tourenspezifische Ausstattungsvarianten bieten auch auf langen Touren viel Komfort
- ▶ Frauen-spezifische Anbauteile ergeben ergonomisch korrekte Kontaktpunkte zum Bike

TARGET GROUP

- ▶ Female bikers looking for a fun allround bike with great handling

ZIELGRUPPE

- ▶ Frauen, die ein wendiges Allroundbike für viel Spaß suchen, sind hier richtig



LANAO FS

// GEOMETRY AND DATA CHARTS / GEOMETRIE UND TECHNISCHE DATEN

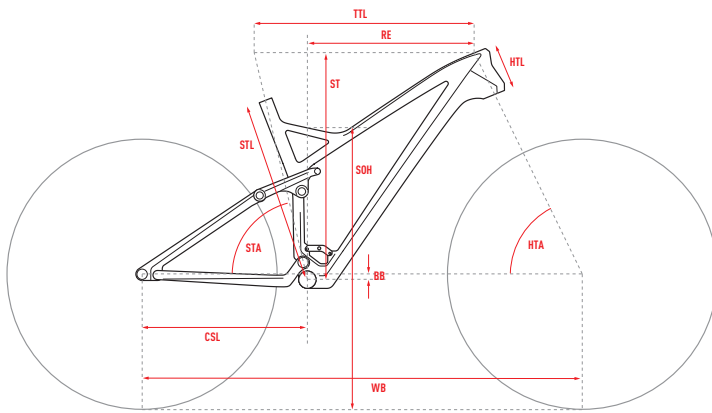

ALL DIMENSIONS IN MM (EXCEPT HTA AND STA IN °)

ALLE MASSE IN MM (AUSNAHME HTA UND STA IN °)

- STL** SEAT TUBE LENGTH
SITZROHRLÄNGE
- CSL** CHAINSTAY LENGTH
KETTENSTREBENLÄNGE
- TTL** TOP TUBE LENGTH
OBERROHRLÄNGE
- HTL** HEADTUBE LENGTH
STEUERROHRLÄNGE
- HTA** HEADTUBE ANGLE
STEUERROHRWINKEL
- STA** SEATTUBE ANGLE
SITZROHRWINKEL
- BB** BB DROP
TRETLAGERABSSENKUNG
- WB** WHEELBASE
RADSTAND
- ST** STACK
STACK
- RE** REACH
REACH
- SOH** STANDOVER HEIGHT
ÜBERSTANDSHÖHE
- SD** HEAD SET DIAMETER (UPPER / LOWER)
STEUERSATZDURCHMESSER (OBEN / UNTEN)
- AS** AXLE STANDARD (REAR / FRONT)
ACHSENSTANDARD (HINTEN / VORNE)
- BS** BOTTOM BRACKET STANDARD
TRETLAGERSTANDARD
- SD** SEAT POST DIAMETER
SITTELSTÜTZENDURCHMESSER
- SH** SHOCK HARDWARE (Ø 8MM)
DÄMPFERBUCHSENMASSE (Ø 8MM)
- SL** SHOCK LENGTH
DÄMPFEREINBAULÄNGE
- ST** SHOCK TRAVEL
DÄMPFERHUB
- FF** FRONT FORK TRAVEL
FEDERWEG VORNE
- FR** REAR WHEEL TRAVEL
FEDERWEG HINTEN
- MS** MIN SADDLE HEIGHT
MIN SITTELHÖHE
- MS** MAX SADDLE HEIGHT
MAX SITTELHÖHE
- MI** MIN INSEAM
MIN SCHRITTLÄNGE
- MI** MAX INSEAM
MAX SCHRITTLÄNGE
- SL** STEM LENGTH
VORBAULÄNGE
- HL** HANDLEBAR WIDTH
LENKERBREITE
- CL** CRANK LENGTH
KURBELLENGE
- SM** SEATTUBE BOTTLE MOUNT
FLASCHE SITTELROHR
- DM** DOWNTUBE BOTTLE MOUNT
FLASCHE UNTERROHR

STL CSL TTL HTL HTA STA BB WB ST RE SOH

LANAO FS 5.7 / 3.7 / 2.7 AL W

	STL	CSL	TTL	HTL	HTA	STA	BB	WB	ST	RE	SOH																
XS	380	430	530	110	69	75	14	1062	586	371	695	ZS44/ZS56	135/100	BSA68	31.6	30/22,2	200	51	130	130	60	760	175	/	/		
S	420	430	560	110	69	75	14	1092	586	401	709	ZS44/ZS56	135/100	BSA68	31.6	30/22,2	200	51	130	130	60	760	175	/	/		
M	460	430	590	120	69	75	14	1123	596	428	740	ZS44/ZS56	135/100	BSA68	31.6	30/22,2	200	51	130	130	60	760	175	/	0.5		
L	500	430	619	130	69	75	14	1158	605	455	752	ZS44/ZS56	135/100	BSA68	31.6	30/22,2	200	51	130	130	75	760	175	/	0.75		



NEON FLAT // neon pink / night black

27.5 AL **LANAO FS 5.7**



MODEL HIGHLIGHTS

- ▶ High-end FOX suspension with lockout
- ▶ Shimano XT components
- ▶ Quality brand Selle Italia saddle

MODELL HIGHLIGHTS

- ▶ High-End FOX Fahrwerk mit Lockout
- ▶ Shimano XT Ausstattung
- ▶ Selle Italia Markensattel

LANA FS AL	Shimano XT FD-M8020 Side Swing	Rodi Blackrock 584x21 mm 32H // Rodi Blackrock 584x21 mm 32H	BSA 68 mm
Fox 32 Float Performance 130 mm	Shimano XT SL-M8000	Shimano Deore HB-M6010 15x100 mm	E21954
Fox Float DPS Performance Air 130 mm	Shimano XT FC-M8000 Hollowtech II 36-26	Shimano Deore FH-M6000 DR	XS-S-M-L
GHOST MTB Dia. 31.8 mm	Shimano SLX CS-M7000 11-42	GHOST Light DC 1 31.6 mm	
GHOST Low Rizer MTB 760 mm Rise 15 mm Dia. 31.8 mm	Shimano XT BR-M8000 2/2 Piston 180 mm Disc	Velo VL-4212	
Shimano XT RD-M8000 Shadow Plus 11-S	Continental X-King PureGrip 27.5x2.2 // Continental X-King PureGrip 27.5x2.2	16012	

SIZE	ARTICLENUMBER	NOTES
SIZE XS	18LA6043	
SIZE S	18LA6044	
SIZE M	18LA6045	
SIZE L	18LA6046	



MODEL HIGHLIGHTS

- ▶ High-end FOX suspension with lockout
- ▶ Shimano XT components
- ▶ Quality brand Selle Italia saddle

MODELL HIGHLIGHTS

- ▶ High-End FOX Fahrwerk mit Lockout
- ▶ Shimano XT Ausstattung
- ▶ Selle Italia Markensattel

LANA0 FS AL	Shimano XT FD-M8020 Side Swing	Rodi Blackrock 584x21 mm 32H // Rodi Blackrock 584x21 mm 32H	BSA 68 mm
Fox 32 Float Performance 130 mm	Shimano XT SL-M8000	Shimano Deore HB-M6010 15x100 mm	EZ1954
Fox Float DPS Performance Air 130 mm	Shimano XT FC-M8000 Hollowtech II 36-26	Shimano Deore FH-M6000 QR	XS-S-M-L
GHOST MTB Dia. 31.8 mm	Shimano SLX CS-M7000 11-42	GHOST Light DC 1 31.6 mm	
GHOST Low Rizer MTB 760 mm Rise 15 mm Dia. 31.8 mm	Shimano XT BR-M8000 2/2 Piston 180 mm Disc	Velo VL-4212	
Shimano XT RD-M8000 Shadow Plus 11-S	Continental X-King PureGrip 27.5x2.2 // Continental X-King PureGrip 27.5x2.2	16012	

SIZE	ARTICLENUMBER	NOTES
SIZE XS	18LA6037	
SIZE S	18LA6038	
SIZE M	18LA6039	
SIZE L	18LA6040	



MODEL HIGHLIGHTS

- ▶ AMR-Series technology
- ▶ Shimano SLX/XT components
- ▶ Reliable and lightweight Suntour AION fork with 34 mm stanchions

MODELL HIGHLIGHTS

- ▶ Technologie der AMR-Serie
- ▶ Shimano SLX/ XT Komponenten
- ▶ Zuverlässige und leichte Suntour AION Federgabel mit 34 mm Standrohren

LANA FS AL	Shimano SLX FD-M7020 Side Swing	Rodri Excalibur XC 584x19 mm 32H // Rodri Excalibur XC 584x19 mm 32H	BSA 68 mm
SR Suntour AION LO-R 130 mm	Shimano SLX SL-M7000	Shimano Deore HB-M6010 15x100 mm	E21954
XFusion O2 Pro RL Air 130 mm	Shimano FC-MT600 36-26	Shimano Deore FH-M6000 DR	XS-S-M-L
GHOST MTB Dia. 31.8 mm	Shimano SLX CS-M7000 11-42	GHOST Light DC 1 31.6 mm	
GHOST Low Rizer MTB 760 mm Rise 15 mm Dia. 31.8 mm	Shimano 506 Disc 2/2 Piston 180 mm Disc	Velo VL-4212	
Shimano XT RD-M8000 Shadow Plus 11-S	Continental X-King PureGrip 27.5x2.2 // Continental X-King PureGrip 27.5x2.2	16012	

SIZE	ARTICLENUMBER	NOTES
SIZE XS	18LA6019	
SIZE S	18LA6020	
SIZE M	18LA6021	
SIZE L	18LA6022	



MODEL HIGHLIGHTS

- ▶ New Shimano Deore M6000 2x10 groupset
- ▶ Lockout suspension by XFusion and RST
- ▶ Quality brand Selle Italia saddle

MODELL HIGHLIGHTS

- ▶ Neue Shimano Deore M6000 2x10-Gruppe
- ▶ Blockierbares Fahrwerk von XFusion und RST
- ▶ Selle Italia Markensattel

LANA FS AL	Shimano Deore FD-M6020 Side Swing	Rodi Excalibur XC 584x19 mm 32H // Rodi Excalibur XC 584x19 mm 32H	BSA 68 mm
RST Aerial TnL Air LO 130 mm	Shimano Deore SL-M6000	Formula DC 20 QR	Ez1954
XFusion 02 Pro RL Air 130 mm	Shimano Deore FC-M6000 Hollowtech II 34-24	Formula DC 22 QR	XS-S-M-L
GHOST MTB Dia. 31.8 mm	Shimano CS-HG500-10 11-42	GHOST Light DC 1 31.6 mm	
GHOST Low Rizer MTB 760 mm Rise 15 mm Dia. 31.8 mm	Tektro HD-M285 2/2 Piston 180 mm Disc	Velo VL-4212	
Shimano Deore RD-M6000 Shadow Plus 10-S	Continental X-King PureGrip 27.5x2.2 // Continental X-King PureGrip 27.5x2.2	16012	

SIZE	ARTICLENUMBER	NOTES
SIZE XS	18LA6007	
SIZE S	18LA6008	
SIZE M	18LA6009	
SIZE L	18LA6010	



+ ERGONOMICALLY CORRECT COMPONENTS SELECTED SPECIFICALLY FOR WOMEN // SPEZIELL AUF DIE ERGONOMIE DER FRAU ABGESTIMMTE ANBAUTEILE

+ MANY EXCITING COLOR OPTIONS // VIELE SPANNENDE FARBOPTIONEN

+ READY FOR DROPPER SEATPOSTS // VARIOSTÜTZEN MÖGLICH

+ 29", 27.5" AND 26" MODELS // 29"-, 27.5"- UND 26"-MODELLE

+ BALANCED GEOMETRY // AUSBALANCIERTE GEOMETRIE

// ALLROUND / TOUR

FEATURES



CHARACTERISTICS

- ▶ The proven geometry guarantees optimum riding characteristics in any situation
- ▶ Attractive designs make for a timeless bike holding its value
- ▶ Women specific components guarantee ergonomically correct contact with the bike
- ▶ The compact cockpit offers a pleasantly upright seating position

CHARAKTERISTIK

- ▶ Die bewährte Geometrie bietet beste Fahreigenschaften in jeder Situation
- ▶ Gefällige Designs ergeben ein zeitlos-wertstabiles Bike
- ▶ Frauen-spezifische Anbauteile ergeben ergonomisch korrekte Kontaktpunkte zum Bike
- ▶ Das kompakte Cockpit bietet eine angenehm aufrechte Sitzposition

TARGET GROUP

- ▶ For all bikers, who are looking for a high quality entry into MTB riding

ZIELGRUPPE

- ▶ Für alle Bikerinnen, die einen hochwertigen Einstieg in den MTB-Sport suchen





// GEOMETRY AND DATA CHARTS / GEOMETRIE UND TECHNISCHE DATEN

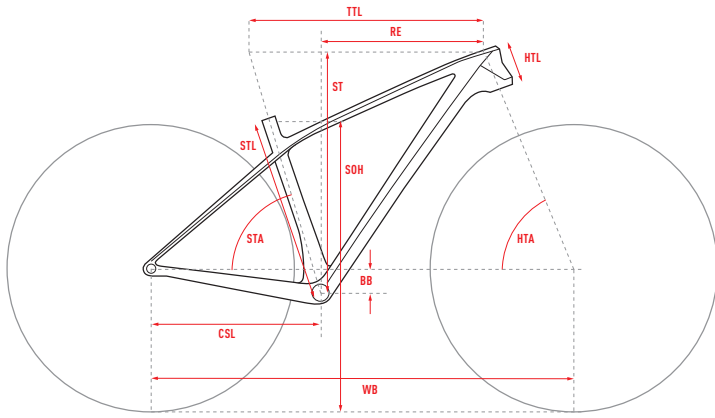

ALL DIMENSIONS IN MM (EXCEPT HTA AND STA IN °)

ALLE MASSE IN MM (AUSNAHME HTA UND STA IN °)

- STL** SEAT TUBE LENGTH
SITZROHRLÄNGE
- CSL** CHAINSTAY LENGTH
KETTENSTREBENLÄNGE
- TTL** TOP TUBE LENGTH
OBERROHRLÄNGE
- HTL** HEADTUBE LENGTH
STEUERROHRLÄNGE
- HTA** HEADTUBE ANGLE
STEUERROHRWINKEL
- STA** SEATTUBE ANGLE
SITZROHRWINKEL
- BB** BB DROP
TRETLAGERABSENKUNG
- WB** WHEELBASE
RADSTAND
- ST** STACK
STACK
- RE** REACH
REACH
- SOH** STANDOVER HEIGHT
ÜBERSTANDSHÖHE
- Head Set Diameter (Upper / Lower)**
STEUERSATZDURCHMESSER (OBEN / UNTEN)
- Axle Standard (Rear / Front)**
ACHSENSTANDARD (HINTEN / VORNE)
- Bottom Bracket Standard**
TRETLAGERSTANDARD
- Seat Post Diameter**
SITZELSTÜTZENDURCHMESSER
- Shock Hardware (Ø 8mm)**
DÄMPFERBUCHSENMASSE (Ø 8MM)
- Shock Length**
DÄMPFEREINBAULÄNGE
- Shock Travel**
DÄMPFERHUB
- Front Fork Travel**
FEDERWEG VORNE
- Rear Wheel Travel**
FEDERWEG HINTEN
- Min Saddle Height**
MIN SÄTTELHÖHE
- Max Saddle Height**
MAX SÄTTELHÖHE
- Min Inseam**
MIN SCHRITTLÄNGE
- Max Inseam**
MAX SCHRITTLÄNGE
- Stem Length**
VORBAULÄNGE
- Handlebar Width**
LENKERBREITE
- Crank Length**
KURBELLENGE
- Seattube Bottle Mount**
FLASCHE SATTELROHR
- Downtube Bottle Mount**
FLASCHE UNTERROHR

	STL	CSL	TTL	HTL	HTA	STA	BB	WB	ST	RE	SOH	Head Set Diameter (Upper / Lower)	Axle Standard (Rear / Front)	Bottom Bracket Standard	Seat Post Diameter	Shock Hardware (Ø 8mm)	Shock Length	Shock Travel	Front Fork Travel	Rear Wheel Travel	Min Saddle Height	Max Saddle Height	Min Inseam	Max Inseam	Stem Length	Handlebar Width	Crank Length	Seattube Bottle Mount	Downtube Bottle Mount		
LANAO 7.9 / 5.9 / 2.9 AL W																															
S	400	455	586	110	69.5	73	65	1114	623	395	678	ZS44/ZS44	135/100	BSA68	31.6	/	/	/	100	/	75	720	175	/	0.75						
M	440	455	601	110	69.5	73	65	1129	623	410	690	ZS44/ZS44	135/100	BSA68	31.6	/	/	/	100	/	75	720	175	/	0.75						
L	480	455	618	120	69.5	73	65	1146	633	425	704	ZS44/ZS44	135/100	BSA68	31.6	/	/	/	100	/	90	720	175	0.75	0.75						
LANAO 7.7 / 5.7 / 4.7 / 3.7 AL W																															
XS	360	435	564	110	69	73	40	1075	585	385	648	ZS44/ZS44	135/100	BSA68	31.6	/	/	/	100	/	60	720	170	/	0.75						
S	400	435	582	120	69	73	40	1094	585	400	678	ZS44/ZS44	135/100	BSA68	31.6	/	/	/	100	/	75	720	170	/	0.75						
M	440	435	599	120	69	73	40	1112	604	415	714	ZS44/ZS44	135/100	BSA68	31.6	/	/	/	100	/	75	720	170	/	0.75						
LANAO 4.9 / 3.9 AL W																															
S	400	455	586	110	69.5	73	65	1114	623	395	678	ZS44/ZS44	135/100	BSA68	31.6	/	/	/	100	/	75	720	170	/	0.75						
M	440	455	601	110	69.5	73	65	1129	623	410	690	ZS44/ZS44	135/100	BSA68	31.6	/	/	/	100	/	75	720	170	/	0.75						
L	480	455	618	120	69.5	73	65	1146	633	425	704	ZS44/ZS44	135/100	BSA68	31.6	/	/	/	100	/	90	720	170	0.75	0.75						
LANAO 2.7 AL W																															
XXS	320	435	541	90	69	73	40	1052	575	365	623	ZS44/ZS44	135/100	BSA68	31.6	/	/	/	100	/	60	720	175	/	0.75						
XS	360	435	564	100	69	73	40	1075	585	385	648	ZS44/ZS44	135/100	BSA68	31.6	/	/	/	100	/	60	720	175	/	0.75						
S	400	435	582	110	69	73	40	1094	585	400	678	ZS44/ZS44	135/100	BSA68	31.6	/	/	/	100	/	75	720	175	/	0.75						
M	440	435	599	120	69	73	40	1112	604	415	714	ZS44/ZS44	135/100	BSA68	31.6	/	/	/	100	/	75	720	175	/	0.75						
LANAO 1.6 AL W																															
XXS	340	425	550	115	71	73.5	35	1030	575	377	615	ZS44/ZS44	135/100	BSA68	31.6	/	/	/	100	/	60	700	175	/	0.5						
XS	380	425	560	125	71	73.5	35	1040	585	385	645	ZS44/ZS44	135/100	BSA68	31.6	/	/	/	100	/	60	700	175	/	0.75						
S	420	425	570	135	71	73.5	35	1050	595	390	660	ZS44/ZS44	135/100	BSA68	31.6	/	/	/	100	/	75	700	175	/	0.75						
M	460	425	588	135	71	73	35	1065	594	407	685	ZS44/ZS44	135/100	BSA68	31.6	/	/	/	100	/	75	700	175	0.5	0.75						
L	500	425	598	145	71	73	35	1075	604	415	717	ZS44/ZS44	135/100	BSA68	31.6	/	/	/	100	/	90	700	175	0.5	0.75						



SHINY // night black / night black / neon red

29 AL **LANAO 7.9**



MODEL HIGHLIGHTS

- ▶ Shimano SLX/XT components
- ▶ Rock Shox suspension fork with remote
- ▶ Female anatomy specific women's saddle

MODELL HIGHLIGHTS

- ▶ Shimano SLX/XT Komponenten
- ▶ Rock Shox Federgabel mit Remote
- ▶ Anatomisch angepasster Damensattel

LANA0 AL	Shimano SLX FD-M7025	Continental X-King PureGrip 29x2.2 // Continental X-King PureGrip 29x2.2	Velo VL-4212
Rock Shox 30 Silver Poploc 100 mm	Shimano SLX SL-M7000	Rudi Blackrock 622x21 mm 32H // Rudi Blackrock 622x21 mm 32H	14358
GHOST MTB Dia. 31.8 mm	Shimano SLX FC-M7000 Hollowtech II 34-24	Shimano HB-RM35 QR	BSA 68 mm
GHOST Low Rizer 720 mm Rise 10 mm Dia. 31.8 mm	Shimano SLX CS-M7000 11-42	Shimano FH-RM35 QR	EZ1954
Shimano XT RD-M7000 Shadow Plus 11-S	Shimano BR-M315 2/2 Piston 180/160 mm Disc	GHOST Light DC 1 31.6 mm	S-M-L

SIZE	ARTICLENUMBER	NOTES
SIZE S	18LA5001	
SIZE M	18LA5002	
SIZE L	18LA5003	



MODEL HIGHLIGHTS

- ▶ Shimano SLX/XT components
- ▶ Rock Shox suspension fork with remote
- ▶ Female anatomy specific women's saddle

MODELL HIGHLIGHTS

- ▶ Shimano SLX/ XT Komponenten
- ▶ Rock Shox Federgabel mit Remote
- ▶ Anatomisch angepasster Damensattel

LANA0 AL	Shimano SLX FD-M7025	Continental X-King PureGrip 27.5x2.2 // Continental X-King PureGrip 27.5x2.2	Velo VL-4212
Rock Shox 30 Silver Poploc 100 mm	Shimano SLX SL-M7000	Rodi Blackrock 584x21 mm 32H // Rodi Blackrock 584x21 mm 32H	16358
GHOST MT8 Dia. 31.8 mm	Shimano SLX FC-M7000 Hollowtech II 34-24	Shimano HB-RM35 QR	BSA 68 mm
GHOST Low Rizer 720 mm Rise 10 mm Dia. 31.8 mm	Shimano SLX CS-M7000 11-42	Shimano FH-RM35 QR	E21954
Shimano XT RD-M7000 Shadow Plus 11-S	Shimano BR-M315 2/2 Piston 180/160 mm Disc	GHOST Light DC 1 31.6 mm	XS-S-M

SIZE	ARTICLENUMBER	NOTES
SIZE XS	18LA3001	
SIZE S	18LA3002	
SIZE M	18LA3003	



NEON FLAT // neon pink / night black

♀ AL **LANAO** 5.9



MODEL HIGHLIGHTS

- ▶ Great price / performance ratio
- ▶ Rock Shox suspension fork with remote
- ▶ Shimano XT rear derailleur

MODELL HIGHLIGHTS

- ▶ Tolles Preis-/ Leistungs-Verhältnis
- ▶ Rock Shox Federgabel
- ▶ Shimano XT Schaltwerk

LANA0 AL	Shimano Acera FD-M3000	Continental X-King PureGrip 29x2.2 // Continental X-King PureGrip 29x2.2	Velo VL-4212
Rock Shox 30 Silver Poploc 100 mm	Shimano Alivio SL-M4000	Rodi Excalibur XC 622x19 mm 32H // Rodi Excalibur XC 622x19 mm 32H	14106
GHOST MTB Dia. 31.8 mm	Shimano FC-M4000 40-30-22	Shimano HB-RM35 QR	BSA 68 mm
GHOST Low Rizer 720 mm Rise 10 mm Dia. 31.8 mm	Shimano CS-HG-200-9 11-34	Shimano FH-RM35 QR	EZ1954
Shimano XT RD-M772 9-S	Shimano BR-M315 2/2 Piston 160 mm Disc	GHOST Light DC 1 31.6 mm	S-M-L

SIZE	ARTICLENUMBER	NOTES
SIZE S	18LA4031	
SIZE M	18LA4032	
SIZE L	18LA4033	



MODEL HIGHLIGHTS

- ▶ Great price / performance ratio
- ▶ Rock Shox suspension fork with remote
- ▶ Shimano XT rear derailleur

MODELL HIGHLIGHTS

- ▶ Tolles Preis-/ Leistungs-Verhältnis
- ▶ Rock Shox Federgabel
- ▶ Shimano XT Schaltwerk

LANA0 AL	Shimano Acera FD-M3000	Continental X-King PureGrip 29x2.2 // Continental X-King PureGrip 29x2.2	Velo VL-4212
Rock Shox 30 Silver Poploc 100 mm	Shimano Alivio SL-M4000	Rodi Excalibur XC 622x19 mm 32H // Rodi Excalibur XC 622x19 mm 32H	14106
GHOST MTB Dia. 31.8 mm	Shimano FC-M4000 40-30-22	Shimano HB-RM35 QR	BSA 68 mm
GHOST Low Rizer 720 mm Rise 10 mm Dia. 31.8 mm	Shimano CS-HG-200-9 11-34	Shimano FH-RM35 QR	EZ1954
Shimano XT RD-M772 9-S	Shimano BR-M315 2/2 Piston 160 mm Disc	GHOST Light DC 1 31.6 mm	S-M-L

SIZE	ARTICLENUMBER	NOTES
SIZE S	18LA4036	
SIZE M	18LA4037	
SIZE L	18LA4038	



NEON FLAT // neon pink / night black



LANAO 5.7



MODEL HIGHLIGHTS

- ▶ Great price / performance ratio
- ▶ Rock Shox suspension fork
- ▶ Shimano XT rear derailleur

MODELL HIGHLIGHTS

- ▶ Tolles Preis-/ Leistungs-Verhältnis
- ▶ Rock Shox Federgabel
- ▶ Shimano XT Schaltwerk

LANA0 AL	Shimano Acera FD-M3000	Continental X-King PureGrip 27.5x2.2 // Continental X-King PureGrip 27.5x2.2	Velo VL-4212
Rock Shox 30 Silver Poploc 100 mm	Shimano Alivio SL-M4000	Rodi Excalibur XC 584x19 mm 32H // Rodi Excalibur XC 584x19 mm 32H	14106
GHOST MTB Dia. 31.8 mm	Shimano FC-M4000 40-30-22	Shimano HB-RM35 DR	BSA 68 mm
GHOST Low Rizer 720 mm Rise 10 mm Dia. 31.8 mm	Shimano CS-HG-200-9 11-34	Shimano FH-RM35 DR	EZ1954
Shimano XT RD-M772 9-S	Shimano BR-M315 2/2 Piston 160 mm Disc	GHOST Light DC 1 31.6 mm	XS-S-M

SIZE	ARTICLENUMBER	NOTES
SIZE XS	18LA2033	
SIZE S	18LA2034	
SIZE M	18LA2035	



MODEL HIGHLIGHTS

- ▶ Great price / performance ratio
- ▶ Rock Shox suspension fork
- ▶ Shimano XT rear derailleur

MODELL HIGHLIGHTS

- ▶ Tolles Preis-/ Leistungs-Verhältnis
- ▶ Rock Shox Federgabel
- ▶ Shimano XT Schaltwerk

LANA0 AL	Shimano Acera FD-M3000	Continental X-King PureGrip 27.5x2.2 // Continental X-King PureGrip 27.5x2.2	Velo VL-4212
Rock Shox 30 Silver Poploc 100 mm	Shimano Alivio SL-M4000	Rodi Excalibur XC 584x19 mm 32H // Rodi Excalibur XC 584x19 mm 32H	14106
GHOST MTB Dia. 31.8 mm	Shimano FC-M4000 40-30-22	Shimano HB-RM35 QR	BSA 68 mm
GHOST Low Rizer 720 mm Rise 10 mm Dia. 31.8 mm	Shimano CS-HG-200-9 11-34	Shimano FH-RM35 QR	EZ1954
Shimano XT RD-M772 9-S	Shimano BR-M315 2/2 Piston 160 mm Disc	GHOST Light DC 1 31.6 mm	XS-S-M

SIZE	ARTICLENUMBER	NOTES
SIZE XS	18LA2038	
SIZE S	18LA2039	
SIZE M	18LA2040	



FLAT // star white / iridium silver / neon pink

♀ AL **LANAO** 4.9



MODEL HIGHLIGHTS

- ▶ Female anatomy specific women's saddle
- ▶ Equipped with Continental quality tires
- ▶ Shimano Deore rear derailleur

MODELL HIGHLIGHTS

- ▶ Anatomisch angepasster Damensattel
- ▶ Continental Markenbereifung
- ▶ Shimano Deore Schaltwerk

LANA AL	Shimano Altus FD-M370	Continental X-King PureGrip 29x2.2 // Continental X-King PureGrip 29x2.2	Velo VL-4212
SR Suntour XCM RL 100 mm	Shimano Altus SL-M2000	Rodi Excalibur XC 622x19 mm 32H // Rodi Excalibur XC 622x19 mm 32H	14106
GHOST MTB Dia. 31.8 mm	Shimano FC-M371 44-32-22	Shimano HB-RM35 DR	BSA 68 mm
GHOST Low Rizer 720 mm Rise 10 mm Dia. 31.8 mm	Shimano CS-HG-200-9 11-34	Shimano FH-RM35 DR	EZ1954
Shimano Deore RD-M592 9-S	Shimano BR-M315 2/2 Piston 160 mm Disc	GHOST Light DC 1 31.6 mm	S-M-L

SIZE	ARTICLENUMBER	NOTES
SIZE S	18LA4021	
SIZE M	18LA4022	
SIZE L	18LA4023	



MODEL HIGHLIGHTS

- ▶ Female anatomy specific women's saddle
- ▶ Equipped with Continental quality tires
- ▶ Shimano Deore rear derailleur

MODELL HIGHLIGHTS

- ▶ Anatomisch angepasster Damensattel
- ▶ Continental Markenbereifung
- ▶ Shimano Deore Schaltwerk

LANA0 AL	Shimano Altus FD-M370	Continental X-King PureGrip 29x2.2 // Continental X-King PureGrip 29x2.2	Velo VL-4212
SR Suntour XCM RL 100 mm	Shimano Altus SL-M2000	Rodi Excalibur XC 622x19 mm 32H // Rodi Excalibur XC 622x19 mm 32H	14106
GHOST MTB Dia. 31.8 mm	Shimano FC-M371 44-32-22	Shimano HB-RM35 QR	BSA 68 mm
GHOST Low Rizer 720 mm Rise 10 mm Dia. 31.8 mm	Shimano CS-HG-200-9 11-34	Shimano FH-RM35 QR	EZ1954
Shimano Deore RD-M592 9-S	Shimano BR-M315 2/2 Piston 160 mm Disc	GHOST Light DC 1 31.6 mm	S-M-L

SIZE	ARTICLENUMBER	NOTES
SIZE S	18LA4026	
SIZE M	18LA4027	
SIZE L	18LA4028	



FLAT // star white / iridium silver / neon pink

♀ AL **LANAO** 4.7



MODEL HIGHLIGHTS

- ▶ Female anatomy specific women's saddle
- ▶ Equipped with Continental quality tires
- ▶ Shimano Deore rear derailleur

MODELL HIGHLIGHTS

- ▶ Anatomisch angepasster Damensattel
- ▶ Continental Markenbereifung
- ▶ Shimano Deore Schaltwerk

LANA AL	Shimano Altus FD-M370	Continental X-King PureGrip 27.5x2.2 // Continental X-King PureGrip 27.5x2.2	Velo VL-4212
SR Suntour XCM RL 100 mm	Shimano Altus SL-M2000	Rodi Excalibur XC 584x19 mm 32H // Rodi Excalibur XC 584x19 mm 32H	14106
GHOST MTB Dia. 31.8 mm	Shimano FC-M371 44-32-22	Shimano HB-RM35 DR	BSA 68 mm
GHOST Low Rizer 720 mm Rise 10 mm Dia. 31.8 mm	Shimano CS-HG-200-9 11-34	Shimano FH-RM35 DR	EZ1954
Shimano Deore RD-M592 9-S	Shimano BR-M315 2/2 Piston 160 mm Disc	GHOST Light DC 1 31.6 mm	XS-S-M

SIZE	ARTICLENUMBER	NOTES
SIZE XS	18LA2023	
SIZE S	18LA2024	
SIZE M	18LA2025	



MODEL HIGHLIGHTS

- ▶ Female anatomy specific women's saddle
- ▶ Equipped with Continental quality tires
- ▶ Shimano Deore rear derailleur

MODELL HIGHLIGHTS

- ▶ Anatomisch angepasster Damensattel
- ▶ Continental Markenbereifung
- ▶ Shimano Deore Schaltwerk

LANA0 AL	Shimano Altus FD-M370	Continental X-King PureGrip 27.5x2.2 // Continental X-King PureGrip 27.5x2.2	Velo VL-4212
SR Suntour XCM RL 100 mm	Shimano Altus SL-M2000	Rodi Excalibur XC 584x19 mm 32H // Rodi Excalibur XC 584x19 mm 32H	14106
GHOST MTB Dia. 31.8 mm	Shimano FC-M371 44-32-22	Shimano HB-RM35 QR	BSA 68 mm
GHOST Low Rizer 720 mm Rise 10 mm Dia. 31.8 mm	Shimano CS-HG-200-9 11-34	Shimano FH-RM35 QR	E21954
Shimano Deore RD-M592 9-S	Shimano BR-M315 2/2 Piston 160 mm Disc	GHOST Light DC 1 31.6 mm	XS-S-M

SIZE	ARTICLENUMBER	NOTES
SIZE XS	18LA2028	
SIZE S	18LA2029	
SIZE M	18LA2030	



MODEL HIGHLIGHTS

- ▶ Shimano Acera 3x8 drivetrain
- ▶ Hydraulic Shimano disc brakes
- ▶ Female anatomy specific women's saddle

MODELL HIGHLIGHTS

- ▶ Shimano Acera 3x8-Antrieb
- ▶ Hydraulische Shimano Scheibenbremsen
- ▶ Anatomisch angepasster Damensattel

LANA0 AL	Shimano Tourney FD-TY700-TS6	Michelin Country Race R 29x2.10 // Michelin Country Race R 29x2.10	Velo VL-4212
RST Blaze RL 100 mm	Shimano SL-M310	Rodi Excalibur XC 622x19 mm 32H // Rodi Excalibur XC 622x19 mm 32H	14106
GHOST MTB Dia. 31.8 mm	Shimano FC-TY501 42-34-24	Shimano HB-RM35 QR	BSA 68 mm
GHOST Low Rizer 720 mm Rise 10 mm Dia. 31.8 mm	Shimano CS-HG-200-8 12-32	Shimano FH-RM35 QR	EZ1954
Shimano Acera RD-M360 8-S	Shimano BR-M315 2/2 Piston 160 mm Disc	GHOST Light DC 1 31.6 mm	S-M-L

SIZE	ARTICLENUMBER	NOTES
SIZE S	18LA4011	
SIZE M	18LA4012	
SIZE L	18LA4013	























MODEL HIGHLIGHTS

- ▶ Shimano Acera 3x8 drivetrain
- ▶ Hydraulic Shimano disc brakes
- ▶ Female anatomy specific women's saddle

MODELL HIGHLIGHTS

- ▶ Shimano Acera 3x8-Antrieb
- ▶ Hydraulische Shimano Scheibenbremsen
- ▶ Anatomisch angepasster Damensattel

 LANA0 AL	 Shimano Tourney FD-TY700-TS6	 Michelin Country Race R 29x2.10 // Michelin Country Race R 29x2.10	 Velo VL-4212
 RST Blaze RL 100 mm	 Shimano SL-M310	 Rodi Excalibur XC 622x19 mm 32H // Rodi Excalibur XC 622x19 mm 32H	 14106
 GHOST MTB Dia. 31.8 mm	 Shimano FC-TY501 42-34-24	 Shimano HB-RM35 QR	 BSA 68 mm
 GHOST Low Rizer 720 mm Rise 10 mm Dia. 31.8 mm	 Shimano CS-HG-200-8 12-32	 Shimano FH-RM35 QR	 EZ1954
 Shimano Acera RD-M360 8-S	 Shimano BR-M315 2/2 Piston 160 mm Disc	 GHOST Light DC 1 31.6 mm	 S-M-L

SIZE	ARTICLENUMBER	NOTES
SIZE S	18LA4016	
SIZE M	18LA4017	
SIZE L	18LA4018	



MODEL HIGHLIGHTS

- ▶ Shimano Acera 3x8 drivetrain
- ▶ Hydraulic Shimano disc brakes
- ▶ Female anatomy specific women's saddle

MODELL HIGHLIGHTS

- ▶ Shimano Acera 3x8-Antrieb
- ▶ Hydraulische Shimano Scheibenbremsen
- ▶ Anatomisch angepasster Damensattel

LANA0 AL	Shimano Tourney FD-TY700-TS6	Michelin Country Race R 27.5x2.10 // Michelin Country Race R 27.5x2.10	Velo VL-4212
RST Blaze RL 100 mm	Shimano SL-M310	Rodi Excalibur XC 584x19 mm 32H // Rodi Excalibur XC 584x19 mm 32H	14106
GHOST MTB Dia. 31.8 mm	Shimano FC-TY501 42-34-24	Shimano HB-RM35 QR	BSA 68 mm
GHOST Low Rizer 720 mm Rise 10 mm Dia. 31.8 mm	Shimano CS-HG-200-8 12-32	Shimano FH-RM35 QR	EZ1954
Shimano Acera RD-M360 8-S	Shimano BR-M315 2/2 Piston 160 mm Disc	GHOST Light DC 1 31.6 mm	XS-S-M

SIZE	ARTICLENUMBER	NOTES
SIZE XS	18LA2013	
SIZE S	18LA2014	
SIZE M	18LA2015	























MODEL HIGHLIGHTS

- ▶ Shimano Acera 3x8 drivetrain
- ▶ Hydraulic Shimano disc brakes
- ▶ Female anatomy specific women's saddle

MODELL HIGHLIGHTS

- ▶ Shimano Acera 3x8-Antrieb
- ▶ Hydraulische Shimano Scheibenbremsen
- ▶ Anatomisch angepasster Damensattel

 LANA0 AL	 Shimano Tourney FD-TY700-TS6	 Michelin Country Race R 27.5x2.10 // Michelin Country Race R 27.5x2.10	 Velo VL-4212
 RST Blaze RL 100 mm	 Shimano SL-M310	 Rodi Excalibur XC 584x19 mm 32H // Rodi Excalibur XC 584x19 mm 32H	 14106
 GHOST MTB Dia. 31.8 mm	 Shimano FC-TY501 42-34-24	 Shimano HB-RM35 QR	 BSA 68 mm
 GHOST Low Rizer 720 mm Rise 10 mm Dia. 31.8 mm	 Shimano CS-HG-200-8 12-32	 Shimano FH-RM35 QR	 EZ1954
 Shimano Acera RD-M360 8-S	 Shimano BR-M315 2/2 Piston 160 mm Disc	 GHOST Light DC 1 31.6 mm	 XS-S-M

SIZE	ARTICLENUMBER	NOTES
SIZE XS	18LA2018	
SIZE S	18LA2019	
SIZE M	18LA2020	



FLAT // star white / electric blue / neon orange

♀ AL **LANAO** 2.9



MODEL HIGHLIGHTS

- ▶ Shimano Acera 3x8 drivetrain
- ▶ Hydraulic Shimano disc brakes
- ▶ Female anatomy specific women's saddle

MODELL HIGHLIGHTS

- ▶ Shimano Acera 3x8-Antrieb
- ▶ Hydraulische Shimano Scheibenbremsen
- ▶ Anatomisch angepasster Damensattel

LANA0 AL	Shimano Tourney FD-TY700-TS6	Michelin Country Race R 29x2.10 // Michelin Country Race R 29x2.10	Velo VL-4212
RST Blaze MLO 100 mm	Shimano SL-M310	Rodi Excalibur XC 622x19 mm 32H // Rodi Excalibur XC 622x19 mm 32H	14106
GHOST MTB Dia. 31.8 mm	Shimano FC-TY301 42-34-24	Formula DC 20 QR	BSA 68 mm
GHOST Low Rizer 720 mm Rise 10 mm Dia. 31.8 mm	Shimano CS-HG-200-8 12-32	Formula DC 22 QR	EZ1954
Shimano Acera RD-M360 8-S	Tektro HD-M285 2/2 Piston 160 mm Disc	GHOST Light DC 1 31.6 mm	S-M-L

SIZE	ARTICLENUMBER	NOTES
SIZE S	18LA4001	
SIZE M	18LA4002	
SIZE L	18LA4003	



MODEL HIGHLIGHTS

- ▶ Shimano Acera 3x8 drivetrain
- ▶ Hydraulic Shimano disc brakes
- ▶ Female anatomy specific women's saddle

MODELL HIGHLIGHTS

- ▶ Shimano Acera 3x8-Antrieb
- ▶ Hydraulische Shimano Scheibenbremsen
- ▶ Anatomisch angepasster Damensattel

LANA0 AL	Shimano Tourney FD-TY700-TS6	Michelin Country Race R 29x2.10 // Michelin Country Race R 29x2.10	Velo VL-4212
RST Blaze MLO 100 mm	Shimano SL-M310	Rodi Excalibur XC 622x19 mm 32H // Rodi Excalibur XC 622x19 mm 32H	14106
GHOST MTB Dia. 31.8 mm	Shimano FC-TY301 42-34-24	Formula DC 20 OR	BSA 68 mm
GHOST Low Rizer 720 mm Rise 10 mm Dia. 31.8 mm	Shimano CS-HG-200-8 12-32	Formula DC 22 OR	EZ1954
Shimano Acera RD-M360 8-S	Tektro HD-M285 2/2 Piston 160 mm Disc	GHOST Light DC 1 31.6 mm	S-M-L

SIZE	ARTICLENUMBER	NOTES
SIZE S	18LA4006	
SIZE M	18LA4007	
SIZE L	18LA4008	



FLAT // star white / electric blue / neon orange

♀ AL **LANAO 2.7**



MODEL HIGHLIGHTS

- ▶ Shimano Acera 3x8 drivetrain
- ▶ Hydraulic Shimano disc brakes
- ▶ Female anatomy specific women's saddle

MODELL HIGHLIGHTS

- ▶ Shimano Acera 3x8-Antrieb
- ▶ Hydraulische Shimano Scheibenbremsen
- ▶ Anatomisch angepasster Damensattel

LANA AL	Shimano Tourney FD-TY700-TS6	Michelin Country Race R 27.5x2.10 // Michelin Country Race R 27.5x2.10	Velo VL-4212
RST Blaze MLO 100 mm	Shimano SL-M310	Rodi Excalibur XC 584x19 mm 32H // Rodi Excalibur XC 584x19 mm 32H	14106
GHOST MTB Dia. 31.8 mm	Shimano FC-TY301 42-34-24	Formula DC 20 QR	BSA 68 mm
GHOST Low Rizer 720 mm Rise 10 mm Dia. 31.8 mm	Shimano CS-HG-200-8 12-32	Formula DC 22 QR	EZ1954
Shimano Acera RD-M360 8-S	Tektro HD-M285 2/2 Piston 160 mm Disc	GHOST Light DC 1 31.6 mm	XXS-XS-S-M

SIZE	ARTICLENUMBER	NOTES
SIZE XXS	18LA2001	
SIZE XS	18LA2002	
SIZE S	18LA2003	
SIZE M	18LA2004	



MODEL HIGHLIGHTS

- ▶ Shimano Acera 3x8 drivetrain
- ▶ Hydraulic Shimano disc brakes
- ▶ Female anatomy specific women's saddle

MODELL HIGHLIGHTS

- ▶ Shimano Acera 3x8-Antrieb
- ▶ Hydraulische Shimano Scheibenbremsen
- ▶ Anatomisch angepasster Damensattel

LANA0 AL	Shimano Tourney FD-TY700-TS6	Michelin Country Race R 27.5x2.10 // Michelin Country Race R 27.5x2.10	Velo VL-4212
RST Blaze MLO 100 mm	Shimano SL-M310	Rodi Excalibur XC 584x19 mm 32H // Rodi Excalibur XC 584x19 mm 32H	14106
GHOST MTB Dia. 31.8 mm	Shimano FC-TY301 42-34-24	Formula DC 20 OR	BSA 68 mm
GHOST Low Rizer 720 mm Rise 10 mm Dia. 31.8 mm	Shimano CS-HG-200-8 12-32	Formula DC 22 OR	EZ1954
Shimano Acera RD-M360 8-S	Tektro HD-M285 2/2 Piston 160 mm Disc	GHOST Light DC 1 31.6 mm	XXS-XS-S-M

SIZE	ARTICLENUMBER	NOTES
SIZE XXS	18LA2007	
SIZE XS	18LA2008	
SIZE S	18LA2009	
SIZE M	18LA2010	



MODEL HIGHLIGHTS

- ▶ For girls and teenagers
- ▶ Suspension fork and disc brakes

MODELL HIGHLIGHTS

- ▶ Für Schülerinnen und Jugendliche
- ▶ Federgabel und Scheibenbremsen

LANA AL	Shimano Tourney FD-TY700-TS6	Michelin Country Race R 26x2.10 // Michelin Country Race R 26x2.10	Velo VL-4212
RST GILA T 100 mm	Shimano Tourney ST-TX800	Alex TD 26 559x20 mm 32H // Alex TD 26 559x20 mm 32H	14106
GHOST MTB Dia. 31.8 mm	Shimano FC-TY301 42-34-24	Shimano HB-TX505 OR	BSA 68 mm
GHOST Low Rizer MTB 700 mm Rise 10 mm Dia. 31.8 mm	Shimano CS-HG-200-8 12-32	Shimano FH-RM33 OR	EZ2036
Shimano Tourney TX RD-TX800 8-S	Shimano mech. Disc BR-M375 2/2 Piston 160 mm Disc	GHOST Light DC 1 31.6 mm	XXS-XS-S-M-L

SIZE	ARTICLENUMBER	NOTES
SIZE XXS	18LA1001	
SIZE XS	18LA1002	
SIZE S	18LA1003	
SIZE M	18LA1004	
SIZE L	18LA1005	



MODEL HIGHLIGHTS

- ▶ For girls and teenagers
- ▶ Suspension fork and disc brakes

MODELL HIGHLIGHTS

- ▶ Für Schülerinnen und Jugendliche
- ▶ Federgabel und Scheibenbremsen

LANA0 AL	Shimano Tourney FD-TY700-TS6	Michelin Country Race R 26x2.10 // Michelin Country Race R 26x2.10	Velo VL-4212
RST GILAT 100 mm	Shimano Tourney ST-TX800	Alex TD 26 559x20 mm 32H // Alex TD 26 559x20 mm 32H	14106
GHOST MTB Dia. 31.8 mm	Shimano FC-TY301 42-34-24	Shimano HB-TX505 QR	BSA 68 mm
GHOST Low Rizer MTB 700 mm Rise 10 mm Dia. 31.8 mm	Shimano CS-HG-200-8 12-32	Shimano FH-RM33 QR	EZ2036
Shimano Tourney TX RD-TX800 8-S	Shimano mech. Disc BR-M375 2/2 Piston 160 mm Disc	GHOST Light DC 1 31.6 mm	XXS-XS-S-M-L

SIZE	ARTICLENUMBER	NOTES
SIZE XXS	18LA1008	
SIZE XS	18LA1009	
SIZE S	18LA1010	
SIZE M	18LA1011	
SIZE L	18LA1012	

NIVOLET X



// ROAD / ADVENTURE

FEATURES



CHARACTERISTICS

- ▶ Lightweight carbon frame with comfortable long-distance geometry
- ▶ Clean internal cable routing in frame and fork
- ▶ Added stiffness thanks to through axles
- ▶ Superior braking performance thanks to hydraulic disc brakes

CHARAKTERISTIK

- ▶ Leichter Carbonrahmen mit angenehmer Langstreckengeometrie
- ▶ Sauber innenverlegte Leitungen in Rahmen und Gabel
- ▶ Erhöhte Steifigkeit dank Steckachsen
- ▶ Übertroffene Bremsleistung dank hydraulischer Disc Brakes

TARGET GROUP

- ▶ Ideal long-distance cruiser for riders focusing on comfort and safety

ZIELGRUPPE

- ▶ Idealer Langstreckentourer für komfort- und sicherheitsorientierte Fahrer



NIVOLET X

// GEOMETRY AND DATA CHARTS / GEOMETRIE UND TECHNISCHE DATEN

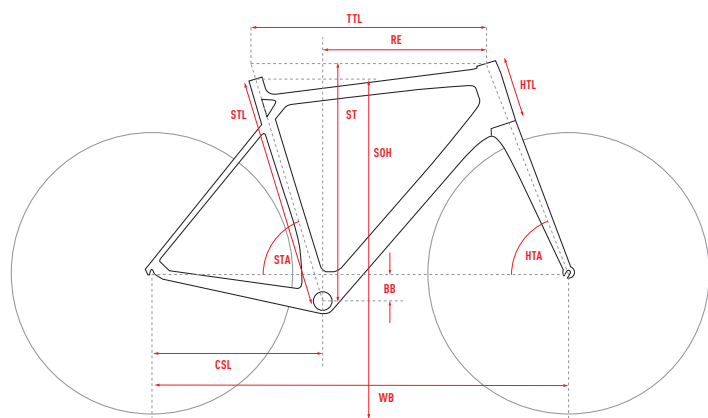

ALL DIMENSIONS IN MM (EXCEPT HTA AND STA IN °)

ALLE MASSE IN MM (AUSNAHME HTA UND STA IN °)

- STL** SEAT TUBE LENGTH
SITZROHRLÄNGE
- CSL** CHAINSTAY LENGTH
KETTENSTREBENLÄNGE
- TTL** TOP TUBE LENGTH
OBERROHRLÄNGE
- HTL** HEADTUBE LENGTH
STEUERROHRLÄNGE
- HTA** HEADTUBE ANGLE
STEUERROHRWINKEL
- STA** SEATTUBE ANGLE
SITZROHRWINKEL
- BB** BB DROP
TRETLAGERABSSENKUNG
- WB** WHEELBASE
RADSTAND
- ST** STACK
STACK
- RE** REACH
REACH
- SOH** STANDOVER HEIGHT
ÜBERSTANDSHÖHE
- HEAD SET DIAMETER (UPPER / LOWER)**
STEUERSATZDURCHMESSER (OBEN / UNTEN)
- AXLE STANDARD (REAR / FRONT)**
ACHSENSTANDARD (HINTEN / VORNE)
- BOTTOM BRACKET STANDARD**
TRETLAGERSTANDARD
- SEAT POST DIAMETER**
SITZSTÜTZENDURCHMESSER
- SHOCK HARDWARE (Ø 8MM)**
DÄMPFERBUCHSENMASSE (Ø 8MM)
- SHOCK LENGTH**
DÄMPFEREINBAULÄNGE
- SHOCK TRAVEL**
DÄMPFERHUB
- FRONT FORK TRAVEL**
FEDERWEG VORNE
- REAR WHEEL TRAVEL**
FEDERWEG HINTEN
- MIN SADDLE HEIGHT**
MIN SÄTTELHÖHE
- MAX SADDLE HEIGHT**
MAX SÄTTELHÖHE
- MIN INSEAM**
MIN SCHRITTLÄNGE
- MAX INSEAM**
MAX SCHRITTLÄNGE
- STEM LENGTH**
VORBAULÄNGE
- HANDLEBAR WIDTH**
LENKERBREITE
- CRANK LENGTH**
KURBELLÄNGE
- SEAT TUBE BOTTLE MOUNT**
FLASCHE SÄTTELROHR
- DOWN TUBE BOTTLE MOUNT**
FLASCHE UNTERROHR

STL CSL TTL HTL HTA STA BB WB ST RE SOH ST DT

NIVOLET X9.8 LC U

	XS	S	M	L	XL
STL	480	510	540	560	580
CSL	404	404	404	404	404
TTL	518	530	546	559	575
HTL	110	130	150	166	185
HTA	70.5	71.8	73	73.5	73.5
STA	73.5	73.5	73	73	72.5
BB	68	68	68	68	68
WB	973	975	974	983	993
ST	506	530	552	570	588
RE	367	373	377	385	390
SOH	726	739	776	795	807
	IS42/IS47	IS42/IS47	IS42/IS47	IS42/IS47	IS42/IS47
	142/100	142/100	142/100	142/100	142/100
	Pressfit86,5	Pressfit86,5	Pressfit86,5	Pressfit86,5	Pressfit86,5
	27.2	27.2	27.2	27.2	27.2
	/	/	/	/	/
	/	/	/	/	/
	/	/	/	/	/
	/	/	/	/	/
	/	/	/	/	/
	80	90	100	110	120
	380	400	400	420	440
	170	170	172.5	172.5	175
	0.75	0.75	0.75	0.75	0.75

NIVOLET X7.8 / 5.8 / 3.8 LC U

	XS	S	M	L	XL
STL	480	510	540	560	580
CSL	404	404	404	404	404
TTL	518	530	546	559	575
HTL	110	130	150	166	185
HTA	70.5	71.8	73	73.5	73.5
STA	73.5	73.5	73	73	72.5
BB	68	68	68	68	68
WB	973	975	974	983	993
ST	506	530	552	570	588
RE	367	373	377	385	390
SOH	726	739	776	795	807
	IS42/IS47	IS42/IS47	IS42/IS47	IS42/IS47	IS42/IS47
	142/100	142/100	142/100	142/100	142/100
	Pressfit86,5	Pressfit86,5	Pressfit86,5	Pressfit86,5	Pressfit86,5
	27.2	27.2	27.2	27.2	27.2
	/	/	/	/	/
	/	/	/	/	/
	/	/	/	/	/
	/	/	/	/	/
	/	/	/	/	/
	75	90	90	100	110
	400	400	420	420	440
	170	170	172.5	172.5	175
	0.75	0.75	0.75	0.75	0.75



MODEL HIGHLIGHTS

- ▶ Shimano Dura-Ace 2x11 drivetrain
- ▶ High quality Mavic Ksyrium Pro wheelset
- ▶ Inner brake cable routing

MODELL HIGHLIGHTS

- ▶ Shimano Dura-Ace 2x11-Antrieb
- ▶ Hochwertiger Mavic Ksyrium Pro Laufradsatz
- ▶ Innenverlegte Bremsleitungen

NIVOLET LC	Shimano Ultegra FD-6800	Mavic Ykson Pro SSC Grip Link 25-622 // Mavic Ykson Pro SSC Power Link 25-622	PressFit 86,5mm
GHOST LC Rigid	Shimano Dura Ace ST-R9120	Mavic Ksyrium Pro Carb SL Disc 25 mm // Mavic Ksyrium Pro Carb SL Disc 25 mm	FRH60023
FSA ST-OS 99 Dia. 31.8 mm	Shimano Dura Ace FC-R9100 Hollowtech II 52-36	FSA K Force 27.2 mm	XS-S-M-L-XL
FSA K Force Ergo Dia. 31.8 mm	Shimano Ultegra CS-R6800 11-28	Selle Italia X1	
Shimano Dura Ace RD-9000 11-S	Shimano Dura Ace BR-R9170 2/2 Piston Flat Mount 160 / 140 mm Disc	14433	

SIZE	ARTICLENUMBER	NOTES
SIZE XS	18N13022	
SIZE S	18N13023	
SIZE M	18N13024	
SIZE L	18N13025	
SIZE XL	18N13026	



MODEL HIGHLIGHTS

- ▶ Continental GP 4000 S II award winning tires
- ▶ Lightweight and reliable Syntace components
- ▶ Shimano Ultegra 2x11 drivetrain

MODELL HIGHLIGHTS

- ▶ Continental GP 4000 S II Testsieger Bereifung
- ▶ Leichte und haltbare Syntace Anbauteile
- ▶ Shimano Ultegra 2x11-Antrieb

NIVOLET LC	Shimano Ultegra FD-R8000	Continental Grand Prix 4000 S II Black Chili 25-622 // Continental Grand Prix 4000 S II Black Chili 25-622	PressFit 86,5mm
GHOST LC Rigid	Shimano Ultegra ST-R8020	Fulcrum Racing 400 DB Wheelset // Fulcrum Racing 400 DB Wheelset	FRHG0023
Syntace Force 109 Dia. 31.8 mm	Shimano Ultegra FC-R8000 Hollowtech II 52-36	Syntace P6 27.2 mm	XS-S-M-L-XL
Syntace Racelite CDR Dia. 31.8 mm	Shimano Ultegra CS-R8000 11-28	Selle Italia X1	
Shimano Ultegra RD-R8000 Shadow Design 11-S	Shimano Ultegra BR-8070 2/2 Piston Flat Mount 160 / 140 mm Disc	14433	

SIZE	ARTICLENUMBER	NOTES
SIZE XS	18NI3015	
SIZE S	18NI3016	
SIZE M	18NI3017	
SIZE L	18NI3018	
SIZE XL	18NI3019	



SHINY // titanium gray / urban gray / neon red

28 LC **NIVOLET X** 5.8



MODEL HIGHLIGHTS

- ▶ Shimano 105 groupset
- ▶ Lightweight and ergonomically GND51 components
- ▶ Fulcrum wheelset system

MODELL HIGHLIGHTS

- ▶ Shimano 105 Gruppe
- ▶ Leichte und ergonomische GND51-Anbauteile
- ▶ Fulcrum Systemlaufradsatz

NIVOLET LC	Shimano 105 FD-5800	Continental Ultra Sport II SL PureGrip 25-622 // Continental Ultra Sport II SL PureGrip 25-622	PressFit 86,5mm
GHOST LC Rigid	Shimano ST-R505	Fulcrum Racing 700 DB Wheelset // Fulcrum Racing 700 DB Wheelset	FRH60023
Ground Fiftyone Dia. 31.8 mm	Shimano 105 FC-5800 Hollowtech II 50-34	Ground Fiftyone 27.2 mm	XS-S-M-L-XL
Ground Fiftyone Race WB 420 mm Dia. 31.8 mm	Shimano 105 CS-5800 11-28	Selle Italia X1	
Shimano 105 RD-5800 11-S	Shimano BR-RS505 2/2 Piston Flat Mount 160 / 140 mm Disc	14433	

SIZE	ARTICLENUMBER	NOTES
SIZE XS	18N13008	
SIZE S	18N13009	
SIZE M	18N13010	
SIZE L	18N13011	
SIZE XL	18N13012	



MODEL HIGHLIGHTS

- ▶ High quality frame at an affordable price point
- ▶ All the benefits of pricier models
- ▶ Shimano Tiagra groupset

MODELL HIGHLIGHTS

- ▶ Hochwertiger Rahmen zum Einstiegspreis
- ▶ Alle Vorteile der teureren Modelle
- ▶ Shimano Tiagra Gruppe

NIVOLET LC	Shimano Tiagra FD-4700	Continental Ultra Sport II SL PureGrip 25-622 // Continental Ultra Sport II SL PureGrip 25-622	Selle Italia X-Base
GHOST LC Rigid	Shimano ST-RS405	Rodi Stradalle Disc 622x17mm 32H // Rodi Stradalle Disc 622x17mm 32H	14433
Ground Fiftyone Dia. 31.8 mm	Shimano Tiagra FC-4700 50-34	Formula CL-712 12 x 100 mm	PressFit 86.5mm
Ground Fiftyone Race WB 420 mm Dia. 31.8 mm	Shimano CS-HG500 11-32	Formula RXC-124S 12x142 mm	FRHG0023
Shimano Tiagra RD-4700 10-S	Shimano BR-RS405 2/2 Piston Flat Mount 160 / 140 mm Disc	Ground Fiftyone 27.2 mm	XS-S-M-L-XL

SIZE	ARTICLENUMBER	NOTES
SIZE XS	18NI3001	
SIZE S	18NI3002	
SIZE M	18NI3003	
SIZE L	18NI3004	
SIZE XL	18NI3005	



// ROAD / RACE

FEATURES



CHARACTERISTICS

- ▶ Fast, but comfortable geometry
- ▶ Aluminum, LC carbon and UC carbon versions
- ▶ Complete groupset models
- ▶ Great price / performance ratio

CHARAKTERISTIK

- ▶ Schnelle, aber gleichzeitig komfortable Geometrie
- ▶ Aluminium, LC-Carbon und UC-Carbon-Versionen
- ▶ Lauter gruppenreine Modelle
- ▶ Tolles Preis-/ Leistungs-Verhältnis

TARGET GROUP

- ▶ For riders who prefer a fast, but not an extreme seating position and geometry

ZIELGRUPPE

- ▶ Für Fahrer, die eine schnelle, aber nicht extreme Position und Geometrie bevorzugen



NIVOLET

// GEOMETRY AND DATA CHARTS / GEOMETRIE UND TECHNISCHE DATEN

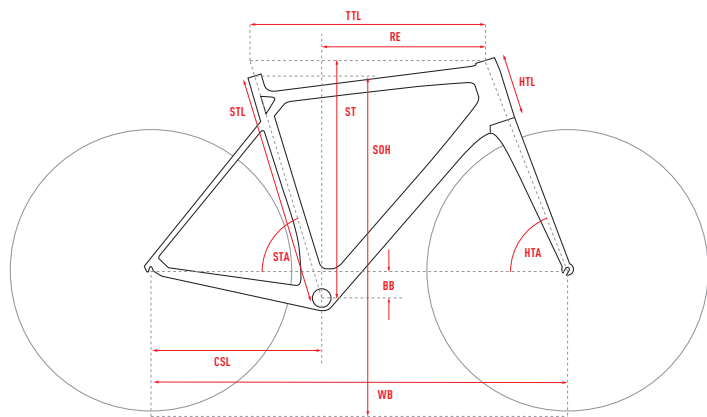

ALL DIMENSIONS IN MM (EXCEPT HTA AND STA IN °)

ALLE MASSE IN MM (AUSNAHME HTA UND STA IN °)

- STL** SEAT TUBE LENGTH
SITZROHRLÄNGE
- CSL** CHAINSTAY LENGTH
KETTENSTREBELÄNGE
- TTL** TOP TUBE LENGTH
OBERROHRLÄNGE
- HTL** HEADTUBE LENGTH
STEUERROHRLÄNGE
- HTA** HEADTUBE ANGLE
STEUERROHRWINKEL
- STA** SEATTUBE ANGLE
SITZROHRWINKEL
- BB** BB DROP
TRETLAGERABSENKUNG
- WB** WHEELBASE
RADSTAND
- ST** STACK
STACK
- RE** REACH
REACH
- SOH** STANDOVER HEIGHT
ÜBERSTANDSHÖHE
- HEAD SET DIAMETER (UPPER / LOWER)
STEUERSATZDURCHMESSER (OBEN / UNTEN)
- AXLE STANDARD (REAR / FRONT)
ACHSENSTANDARD (HINTEN / VORNE)
- BOTTOM BRACKET STANDARD
TRETLAGERSTANDARD
- SEAT POST DIAMETER
SITZSTÜTZENDURCHMESSER
- SHOCK HARDWARE (Ø 8MM)
DÄMPFERBUCHSENMASSE (Ø 8MM)
- SHOCK LENGTH
DÄMPFEREINBAULÄNGE
- SHOCK TRAVEL
DÄMPFERHUB
- FRONT FORK TRAVEL
FEDERWEG VORNE
- REAR WHEEL TRAVEL
FEDERWEG HINTEN
- MIN SADDLE HEIGHT
MIN SÄTTELHÖHE
- MAX SADDLE HEIGHT
MAX SÄTTELHÖHE
- MIN INSEAM
MIN SCHRITTLÄNGE
- MAX INSEAM
MAX SCHRITTLÄNGE
- STEM LENGTH
VORBAULÄNGE
- HANDLEBAR WIDTH
LENKERBREITE
- CRANK LENGTH
KURBELLENGE
- SEAT TUBE BOTTLE MOUNT
FLASCHE SÄTTELROHR
- DOWNTUBE BOTTLE MOUNT
FLASCHE UNTERROHR

STL CSL TTL HTL HTA STA BB WB ST RE SOH

NIVOLET 7.8 UC U

	STL	CSL	TTL	HTL	HTA	STA	BB	WB	ST	RE	SOH																			
XXS	450	399	510	105	70	74	68	968	500	366	685	IS42/IS47	130/100	Pressfit86,5	27.2	/	/	/	/	/	80	380	170	0.75	0.75					
XS	480	399	518	110	70.5	73.5	68	968	505	367	710	IS42/IS47	130/100	Pressfit86,5	27.2	/	/	/	/	/	80	380	170	0.75	0.75					
S	510	399	530	130	71.8	73.5	68	970	530	373	722	IS42/IS47	130/100	Pressfit86,5	27.2	/	/	/	/	/	90	400	170	0.75	0.75					
M	540	399	546	150	73	73	68	970	552	377	760	IS42/IS47	130/100	Pressfit86,5	27.2	/	/	/	/	/	100	400	172.5	0.75	0.75					
L	560	399	559	165	73.5	73	68	978	570	385	783	IS42/IS47	130/100	Pressfit86,5	27.2	/	/	/	/	/	110	420	175	0.75	0.75					
XL	580	399	575	185	73.5	72.5	68	988	588	390	790	IS42/IS47	130/100	Pressfit86,5	27.2	/	/	/	/	/	120	440	175	0.75	0.75					
XXL	610	399	590	210	73.5	72.5	68	1002	612	397	820	IS42/IS47	130/100	Pressfit86,5	27.2	/	/	/	/	/	120	440	175	0.75	0.75					

NIVOLET 8.8 / 6.8 / 4.8 LC U

	STL	CSL	TTL	HTL	HTA	STA	BB	WB	ST	RE	SOH																			
XXS	450	399	510	105	70	74	68	968	500	366	685	IS42/IS47	130/100	Pressfit86,5	27.2	/	/	/	/	/	75	400	170	0.75	0.75					
XS	480	399	518	110	70.5	73.5	68	968	505	367	710	IS42/IS47	130/100	Pressfit86,5	27.2	/	/	/	/	/	75	400	170	0.75	0.75					
S	510	399	530	130	71.8	73.5	68	970	530	373	722	IS42/IS47	130/100	Pressfit86,5	27.2	/	/	/	/	/	90	400	170	0.75	0.75					
M	540	399	546	150	73	73	68	970	552	377	760	IS42/IS47	130/100	Pressfit86,5	27.2	/	/	/	/	/	90	420	172.5	0.75	0.75					
L	560	399	559	165	73.5	73	68	978	570	385	783	IS42/IS47	130/100	Pressfit86,5	27.2	/	/	/	/	/	100	420	172.5	0.75	0.75					
XL	580	399	575	185	73.5	72.5	68	988	588	390	790	IS42/IS47	130/100	Pressfit86,5	27.2	/	/	/	/	/	110	440	175	0.75	0.75					
XXL	610	399	590	210	73.5	72.5	68	1002	612	397	820	IS42/IS47	130/100	Pressfit86,5	27.2	/	/	/	/	/	110	440	175	0.75	0.75					

NIVOLET 2.8 AL U

	STL	CSL	TTL	HTL	HTA	STA	BB	WB	ST	RE	SOH																			
XS	460	406	518	120	71.5	74.5	67	977	514	376	695	IS42/IS47	130/100	BSA 68	27.2	/	/	/	/	/	75	400	170	0.5	0.75					
S	490	406	530	140	72	74	67	981	535	377	720	IS42/IS47	130/100	BSA 68	27.2	/	/	/	/	/	90	400	170	0.5	0.75					
M	520	406	546	160	72.5	73	67	982	556	376	745	IS42/IS47	130/100	BSA 68	27.2	/	/	/	/	/	90	420	172.5	0.75	0.75					
L	550	406	565	180	73	72.5	67	991	577	384	775	IS42/IS47	130/100	BSA 68	27.2	/	/	/	/	/	100	420	172.5	0.75	0.75					
XL	580	406	585	200	73	72	67	1005	596	392	800	IS42/IS47	130/100	BSA 68	27.2	/	/	/	/	/	110	440	175	0.75	0.75					



FLAT // titanium gray / silver gray / night black

28 UC **NIVOLET** 7.8



MODEL HIGHLIGHTS

- ▶ Ultralight SRAM Force carbon 2x11-groupset
- ▶ Mavic Ksyrium Elite wheelset
- ▶ Ultralight frame

MODELL HIGHLIGHTS

- ▶ Ultraleichte SRAM Force Carbon 2x11-Gruppe
- ▶ Mavic Ksyrium Elite Laufradsatz
- ▶ Ultraleichter Rahmen

NIVOLET UC	SRAM Force	Mavic Ykson Pro Grip Link 25-622 // Mavic Ykson Pro Power Link 25-622	PressFit 86,5 mm
GHOST LC Rigid	SRAM Force	Mavic Ksyrium Elite 17 mm Wheelset // Mavic Ksyrium Elite 17 mm Wheelset	E21059
FSA ST-OS 99 Dia. 31.8 mm	SRAM Force 50-34	FSA K Force 27.2 mm	XXS-XS-S-M-L-XL-XXL
FSA K Force Ergo Dia. 31.8 mm	SRAM PG 1170 11-28	Selle Italia SL	
SRAM Force 11-S	SRAM Force	14433	

SIZE	ARTICLENUMBER	NOTES
SIZE XXS	18N12001	
SIZE XS	18N12002	
SIZE S	18N12003	
SIZE M	18N12004	
SIZE L	18N12005	
SIZE XL	18N12006	
SIZE XXL	18N12007	



MODEL HIGHLIGHTS

- ▶ Shimano Ultegra Di2-groupset
- ▶ Lightweight and ergonomical GND51 components
- ▶ Fulcrum wheelset system

MODELL HIGHLIGHTS

- ▶ Shimano Ultegra Di2-Gruppe
- ▶ Leichte und ergonomische GND51-Anbauteile
- ▶ Fulcrum Systemlaufradsatz

NIVOLET LC	Shimano Ultegra Di2 FD-R8050	Continental Grand Prix 4000 S II Black Chili 25-622 // Continental Grand Prix 4000 S II Black Chili 25-622	PressFit 86,5 mm
GHOST LC Rigid	Shimano Ultegra Di2 ST-R8050	Fulcrum Racing 5 LG 23 mm Wheelset // Fulcrum Racing 5 LG 23 mm Wheelset	EZ1859
Ground Fiftyone Dia. 31.8 mm	Shimano Ultegra FC-R8000 Hollowtech II 52-36	Ground Fiftyone 27.2 mm	XXS-XS-S-M-L-XL-XXL
Ground Fiftyone Race WB 420 mm Dia. 31.8 mm	Shimano Ultegra CS-R8000 11-28	Selle Italia SL	
Shimano Ultegra Di2 RD-R8050 Shadow Design 11-S	Shimano Ultegra BR-R8000	14433	

SIZE	ARTICLENUMBER	NOTES
SIZE XXS	18N11019	
SIZE XS	18N11020	
SIZE S	18N11021	
SIZE M	18N11022	
SIZE L	18N11023	
SIZE XL	18N11024	
SIZE XXL	18N11025	



SHINY // titanium gray / urban gray / neon orange

28 LC **NIVOLET** 6.8



MODEL HIGHLIGHTS

- ▶ "Rennrad" magazine recommendation award for 2017
- ▶ Continental GP 4000 S II award winning tires
- ▶ Very versatile geometry

MODELL HIGHLIGHTS

- ▶ 2017 der „Rennrad“-Magazin-Kauf Tipp
- ▶ Continental GP 4000 S II Testsieger Bereifung
- ▶ Sehr angenehme Geometrie

NIVOLET LC	Shimano Ultegra FD-R8000	Continental Grand Prix 4000 S II Black Chili 25-622 // Continental Grand Prix 4000 S II Black Chili 25-622	PressFit 86,5 mm
GHOST LC Rigid	Shimano Ultegra ST-R8000	Fulcrum Racing 5 LG 23 mm Wheelset // Fulcrum Racing 5 LG 23 mm Wheelset	E21059
Ground Fiftyone Dia. 31.8 mm	Shimano Ultegra FC-R8000 Hollowtech II 52-36	Ground Fiftyone 27.2 mm	XXS-XS-S-M-L-XL-XXL
Ground Fiftyone Race WB 420 mm Dia. 31.8 mm	Shimano Ultegra CS-R8000 11-28	Selle Italia SL	
Shimano Ultegra RD-R8000 Shadow Design 11-S	Shimano Ultegra BR-R8000	14433	

SIZE	ARTICLENUMBER	NOTES
SIZE XXS	18N11010	
SIZE XS	18N11011	
SIZE S	18N11012	
SIZE M	18N11013	
SIZE L	18N11014	
SIZE XL	18N11015	
SIZE XXL	18N11016	



MODEL HIGHLIGHTS

- ▶ Entry into the carbon frame roadbike level
- ▶ Shimano 105-groupset
- ▶ Lightweight and ergonomical GND51 components

MODELL HIGHLIGHTS

- ▶ Einstieg in die Carbon-Rennradwelt
- ▶ Shimano 105-Gruppe
- ▶ Leichte und ergonomische GND51-Anbauteile

NIVOLET LC	Shimano 105 FD-5800	Continental Ultra Sport II SL 25-622 // Continental Ultra Sport II SL 25-622	PressFit 86,5 mm
GHOST LC Rigid	Shimano 105 ST-5800	Fulcrum Racing 7 LG 23 mm Wheelset // Fulcrum Racing 7 LG 23 mm Wheelset	EZ1859
Ground Fiftyone Dia. 31.8 mm	Shimano 105 FC-5800 Hollowtech II 50-34	Ground Fiftyone 27.2 mm	XXS-XS-S-M-L-XL-XXL
Ground Fiftyone Race WB 420 mm Dia. 31.8 mm	Shimano 105 CS-5800 11-28	Selle Italia SL	
Shimano 105 RD-5800 11-S	Shimano 105 BR-5800	14433	

SIZE	ARTICLENUMBER	NOTES
SIZE XXS	18N11001	
SIZE XS	18N11002	
SIZE S	18N11003	
SIZE M	18N11004	
SIZE L	18N11005	
SIZE XL	18N11006	
SIZE XXL	18N11007	



SHINY // night black / titanium gray

28 AL **NIVOLET** 2.8



MODEL HIGHLIGHTS

- ▶ Light aluminum frame with comfortable race geometry
- ▶ Comfortable and light carbon fork
- ▶ Lightweight and ergonomical GND51 components

MODELL HIGHLIGHTS

- ▶ Leichter Aluminiumrahmen mit komfortabler Race-Geometrie
- ▶ Komfortable und leichte Carbongabel
- ▶ Leichte und ergonomische GND51-Anbauteile

NIVOLET AL	Shimano Tiagra FD-4700	Schwalbe Lugano Silica 25-622 // Schwalbe Lugano Silica 25-622	BSA 68 mm
GHOST LC Rigid	Shimano Tiagra ST-4700/4703	FSA Vision Team 25 mm Clincher Wheelset // FSA Vision Team 25 mm Clincher Wheelset	E21050
Ground Fiftyone Dia. 31.8 mm	Shimano Tiagra FC-4700 50-34	Ground Fiftyone 27.2 mm	XS-S-M-L-XL
Ground Fiftyone Race WB 420 mm Dia. 31.8 mm	Shimano CS-HG500 11-28	Selle Italia X-Base	
Shimano Tiagra RD-4700 10-S	Shimano Tiagra BR-4700	14433	

SIZE	ARTICLENUMBER	NOTES
SIZE XS	18N14001	
SIZE S	18N14002	
SIZE M	18N14003	
SIZE L	18N14004	
SIZE XL	18N14005	

SQUARE^{URBAN X}



// URBAN / COMMUTE

FEATURES



CHARACTERISTICS

- ▶ Equipped with lights, dynamo hub and fenders
- ▶ All bicycles with high-quality Gates belt drive
- ▶ 11-speed Alfine hubs for great bandwidth

CHARAKTERISTIK

- ▶ Ausgestattet mit Licht, Nabendynamo und Schutzblechen
- ▶ Alle Räder mit hochwertigen Gates-Riemenantrieb
- ▶ 11-Gang Alfine-Naben für große Bandbreite

TARGET GROUP

- ▶ Perfect for commuters: with lights, fenders and belt drive

ZIELGRUPPE

- ▶ Perfekt für Pendler: mit Licht, Schutzblechen und Riemenantrieb



SQUARE^{URBAN X}

// GEOMETRY AND DATA CHARTS / GEOMETRIE UND TECHNISCHE DATEN

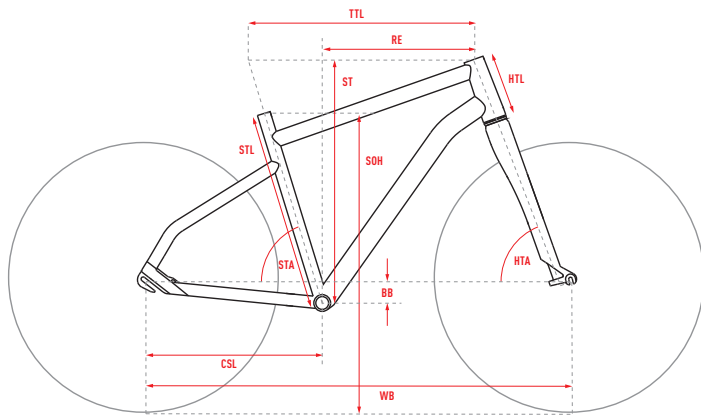

ALL DIMENSIONS IN MM (EXCEPT HTA AND STA IN °)

ALLE MASSE IN MM (AUSNAHME HTA UND STA IN °)

- STL** SEAT TUBE LENGTH
SITZROHRLÄNGE
- CSL** CHAINSTAY LENGTH
KETTENSTREBENLÄNGE
- TTL** TOP TUBE LENGTH
OBERROHRLÄNGE
- HTL** HEADTUBE LENGTH
STEUERROHRLÄNGE
- HTA** HEADTUBE ANGLE
STEUERROHRWINKEL
- STA** SEATTUBE ANGLE
SITZROHRWINKEL
- BB** BB DROP
TRETLAGERABSSENKUNG
- WB** WHEELBASE
RADSTAND
- ST** STACK
STACK
- RE** REACH
REACH
- SOH** STANDOVER HEIGHT
ÜBERSTANDSHÖHE
- HEAD SET DIAMETER (UPPER / LOWER)**
STEUERSATZDURCHMESSER (OBEN / UNTEN)
- AXLE STANDARD (REAR / FRONT)**
ACHSENSTANDARD (HINTEN / VORNE)
- BOTTOM BRACKET STANDARD**
TRETLAGERSTANDARD
- SEAT POST DIAMETER**
SITZSTÜTZENDURCHMESSER
- SHOCK HARDWARE (Ø 8MM)**
DÄMPFERBUCHSENMASSE (Ø 8MM)
- SHOCK LENGTH**
DÄMPFEREINBAULÄNGE
- SHOCK TRAVEL**
DÄMPFERHUB
- FRONT FORK TRAVEL**
FEDERWEG VORNE
- REAR WHEEL TRAVEL**
FEDERWEG HINTEN
- MIN SADDLE HEIGHT**
MIN SITZELHÖHE
- MAX SADDLE HEIGHT**
MAX SITZELHÖHE
- MIN INSEAM**
MIN SCHRITTLÄNGE
- MAX INSEAM**
MAX SCHRITTLÄNGE
- STEM LENGTH**
VORBAULÄNGE
- HANDLEBAR WIDTH**
LENKERBREITE
- CRANK LENGTH**
KURBELLÄNGE
- SEATTUBE BOTTLE MOUNT**
FLASCHE SATTELROHR
- DOWNTUBE BOTTLE MOUNT**
FLASCHE UNTERROHR

STL CSL TTL HTL HTA STA BB WB ST RE SOH ST DT

SQUARE URBAN X7.8 AL U

	STL	CSL	TTL	HTL	HTA	STA	BB	WB	ST	RE	SOH																		
S	470	455	580	160	70	73.5	60	1105	636	391	735	ZS44/ZS56	135/100	BSA 68	31.6	/	/	/	/	/	/	/	80	700	175	0.75	0.75		
M	520	455	595	165	70	72.5	60	1108	641	393	770	ZS44/ZS56	135/100	BSA 68	31.6	/	/	/	/	/	/	/	80	700	175	0.75	0.75		
L	570	455	610	185	71	72.5	60	1112	664	400	815	ZS44/ZS56	135/100	BSA 68	31.6	/	/	/	/	/	/	/	80	700	175	0.75	0.75		
XL	620	455	625	205	71	72	60	1121	683	403	855	ZS44/ZS56	135/100	BSA 68	31.6	/	/	/	/	/	/	/	80	700	175	0.75	0.75		

SQUARE URBAN X7.8 AL W

	STL	CSL	TTL	HTL	HTA	STA	BB	WB	ST	RE	SOH																		
XS	420	455	560	150	70.5	73	60	1073	629	368	630	ZS44/ZS56	135/100	BSA 68	31.6	/	/	/	/	/	/	/	80	700	170	/	0.75		
S	470	455	575	155	70.5	72	60	1076	634	369	625	ZS44/ZS56	135/100	BSA 68	31.6	/	/	/	/	/	/	/	80	700	170	/	0.75		
M	520	455	590	170	70.5	72	60	1091	648	379	625	ZS44/ZS56	135/100	BSA 68	31.6	/	/	/	/	/	/	/	80	700	170	/	0.75		
L	560	455	610	185	70.5	72	60	1112	662	395	625	ZS44/ZS56	135/100	BSA 68	31.6	/	/	/	/	/	/	/	80	700	170	/	0.75		



MODEL HIGHLIGHTS

- ▶ Shimano Alfine 11-speed hub drive
- ▶ Integrated fenders and lighting system
- ▶ High quality and reliability thanks to Gates Carbon drive belt

MODELL HIGHLIGHTS

- ▶ Shimano Alfine-11-Gang Nabe
- ▶ Integrierte Schutzbleche mit Beleuchtung
- ▶ Zuverlässig und hochwertig: Gates Carbon Drive Riemen

SQUARE Urban AL	Shimano Alfine SL	KT Dynamo Hub JH-KC6F QR	Supernova E3 Pure3
GHOST AL Rigid	Gates Carbon Drive S150 46T	Shimano Alfine SG-S7001-11 11-Speed	Supernova Tail Light
Satori HL STEALTH 6 Dia. 31.8 mm	Gates Carbon Drive Polymer Ceramic 24	Satori HL Comet 31.6 mm	16358
Satori Deviant Bow 700 mm Rise 12 mm Dia. 31.8 mm	Shimano BR-M315 2/2 Piston 160 mm Disc	Justek 2059 HRN	BSA 68 mm
-	Continental Sport Contact II SL 37-622 // Continental Sport Contact II SL 37-622	GHOST SQUARE Urban Carrier	-
-	Rodi Excalibur XC 622x19 mm 32H // Rodi Excalibur XC 622x19 mm 32H	GHOST RG40	S-M-L-XL

SIZE	ARTICLENUMBER	NOTES
SIZE S	18SU2013	
SIZE M	18SU2014	
SIZE L	18SU2015	
SIZE XL	18SU2016	



MODEL HIGHLIGHTS

- ▶ Shimano Alfine 11-speed hub drive
- ▶ High quality and reliability thanks to Gates Carbon drive belt
- ▶ Integrated fenders and lighting system

MODELL HIGHLIGHTS

- ▶ Shimano Alfine 11-Gang Nabe
- ▶ Zuverlässig und hochwertig: Gates Carbon Drive Riemen
- ▶ Integrierte Schutzbleche mit Beleuchtung

SQUARE Urban AL	Shimano Alfine SL	KT Dynamo Hub JH-KC6F DR	Supernova E3 Pure3
GHOST AL Rigid	Gates Carbon Drive S150 46T	Shimano Alfine SG-S7001-11 11-Speed	Supernova Tail Light
Satori HL STEALTH 6 Dia. 31.8 mm	Gates Carbon Drive Polymer Ceramic 24	Satori HL Comet 31.6 mm	16358
Satori Deviant Bow 700 mm Rise 12 mm Dia. 31.8 mm	Shimano BR-M315 2/2 Piston 160 mm Disc	Justek 2059 DRN	BSA 68 mm
-	Continental Sport Contact II SL 37-622 // Continental Sport Contact II SL 37-622	GHOST SQUARE Urban Carrier	-
-	Rodi Excalibur XC 622x19 mm 32H // Rodi Excalibur XC 622x19 mm 32H	GHOST RG40	XS-S-M-L

SIZE	ARTICLENUMBER	NOTES
SIZE XS	18SU4013	
SIZE S	18SU4014	
SIZE M	18SU4015	
SIZE L	18SU4016	

SQUARE^{URBAN}



+ GEAR HUB // NABENSCHALTUNG

+ CLEAN CABLE ROUTING WITH EASY ACCESS // SAUBERE ZUGVERLEGUNG MIT LEICHTEM ZUGANG

+ STYLISH GHOST RIGID FORK // STYLISCHE GHOST-STARRGABEL

+ RELIABLE GATES CARBON DRIVE BELT // ZUVERLÄSSIGER GATES CARBON DRIVE RIEMEN

// URBAN / STYLE

FEATURES



CHARACTERISTICS

- ▶ With integrated carrier and fenders
- ▶ Great equipment at an attractive pricepoint
- ▶ Automatix or 8-speed Nexus drive system

CHARAKTERISTIK

- ▶ Mit integriertem Gepäckträger und Schutzblechen
- ▶ Toll ausgestattet zum attraktiven Preis
- ▶ Automatix oder 8-Gang Nexus-Antrieb

TARGET GROUP

- ▶ For sportive, trendy commuters in metropolitan areas

ZIELGRUPPE

- ▶ Für sportliche, designorientierte Biker im Großstadtdschungel



SQUARE^{URBAN}

// GEOMETRY AND DATA CHARTS / GEOMETRIE UND TECHNISCHE DATEN

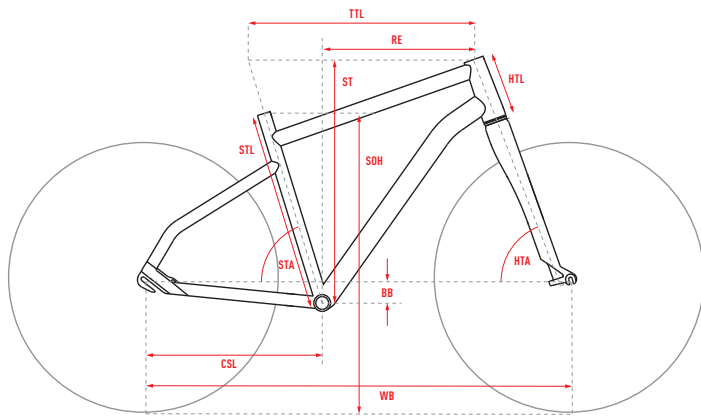

ALL DIMENSIONS IN MM (EXCEPT HTA AND STA IN °)

ALLE MASSE IN MM (AUSNAHME HTA UND STA IN °)

- STL** SEAT TUBE LENGTH
SITZROHRLÄNGE
- CSL** CHAINSTAY LENGTH
KETTENSTREBENLÄNGE
- TTL** TOP TUBE LENGTH
OBERROHRLÄNGE
- HTL** HEADTUBE LENGTH
STEUERROHRLÄNGE
- HTA** HEADTUBE ANGLE
STEUERROHRWINKEL
- STA** SEATTUBE ANGLE
SITZROHRWINKEL
- BB** BB DROP
TRETLAGERABSSENKUNG
- WB** WHEELBASE
RADSTAND
- ST** STACK
STACK
- RE** REACH
REACH
- SOH** STANDOVER HEIGHT
ÜBERSTANDSHÖHE
- HEAD SET DIAMETER (UPPER / LOWER)**
STEUERSATZDURCHMESSER (OBEN / UNTEN)
- AXLE STANDARD (REAR / FRONT)**
ACHSENSTANDARD (HINTEN / VORNE)
- BOTTOM BRACKET STANDARD**
TRETLAGERSTANDARD
- SEAT POST DIAMETER**
SITZSTÜTZENDURCHMESSER
- SHOCK HARDWARE (Ø 8MM)**
DÄMPFERBUCHSENMASSE (Ø 8MM)
- SHOCK LENGTH**
DÄMPFEREINBAULÄNGE
- SHOCK TRAVEL**
DÄMPFERHUB
- FRONT FORK TRAVEL**
FEDERWEG VORNE
- REAR WHEEL TRAVEL**
FEDERWEG HINTEN
- MIN SADDLE HEIGHT**
MIN SATTELHÖHE
- MAX SADDLE HEIGHT**
MAX SATTELHÖHE
- MIN INSEAM**
MIN SCHRITTLÄNGE
- MAX INSEAM**
MAX SCHRITTLÄNGE
- STEM LENGTH**
VORBAULÄNGE
- HANDLEBAR WIDTH**
LENKERBREITE
- CRANK LENGTH**
KURBELLÄNGE
- SEATTUBE BOTTLE MOUNT**
FLASCHE SATTELROHR
- DOWNTUBE BOTTLE MOUNT**
FLASCHE UNTERROHR

STL CSL TTL HTL HTA STA BB WB ST RE SOH ST DT

SQUARE URBAN 5.8 / 3.8 AL U

	S	M	L	XL
STL	470	455	580	160
CSL	470	455	595	165
TTL	70	70	71	72
HTL	73.5	72.5	72.5	71
HTA	60	60	60	60
STA	1105	1108	1112	1121
BB	636	641	664	683
WB	391	393	400	403
ST	735	770	815	855
RE	ZS44/ZS56	ZS44/ZS56	ZS44/ZS56	ZS44/ZS56
SOH	135/100	135/100	135/100	135/100
	BSA 68	BSA 68	BSA 68	BSA 68
	31.6	31.6	31.6	31.6
	/	/	/	/
	/	/	/	/
	/	/	/	/
	/	/	/	/
	80	700	175	0.75
	0.75	0.75	0.75	0.75
	0.75	0.75	0.75	0.75
	0.75	0.75	0.75	0.75
	0.75	0.75	0.75	0.75
	0.75	0.75	0.75	0.75
	0.75	0.75	0.75	0.75
	0.75	0.75	0.75	0.75
	0.75	0.75	0.75	0.75
	0.75	0.75	0.75	0.75
	0.75	0.75	0.75	0.75
	0.75	0.75	0.75	0.75

SQUARE URBAN 5.8 / 3.8 AL W

	XS	S	M	L
STL	420	455	560	150
CSL	420	455	575	155
TTL	70.5	70.5	70.5	72
HTL	73	72	72	72
HTA	60	60	60	60
STA	1073	1076	1091	1112
BB	629	634	648	662
WB	368	369	379	395
ST	630	625	625	625
RE	ZS44/ZS56	ZS44/ZS56	ZS44/ZS56	ZS44/ZS56
SOH	135/100	135/100	135/100	135/100
	BSA 68	BSA 68	BSA 68	BSA 68
	31.6	31.6	31.6	31.6
	/	/	/	/
	/	/	/	/
	/	/	/	/
	/	/	/	/
	80	700	170	/
	0.75	0.75	0.75	0.75
	0.75	0.75	0.75	0.75
	0.75	0.75	0.75	0.75
	0.75	0.75	0.75	0.75
	0.75	0.75	0.75	0.75
	0.75	0.75	0.75	0.75
	0.75	0.75	0.75	0.75
	0.75	0.75	0.75	0.75
	0.75	0.75	0.75	0.75
	0.75	0.75	0.75	0.75
	0.75	0.75	0.75	0.75



FLAT // urban gray / iridium silver / night black

28 AL **SQUARE** URBAN 5.8



MODEL HIGHLIGHTS

- ▶ Shimano Nexus 8-speed hub drive
- ▶ High quality and reliability thanks to Gates Carbon drive belt

MODELL HIGHLIGHTS

- ▶ Shimano Nexus 8-Gang Nabe
- ▶ Zuverlässig und hochwertig: Gates Carbon Drive Riemenantrieb

SQUARE Urban AL	Shimano Alfine SL	Shimano HB-RM35 QR	16358
GHOST AL Rigid	Gates Carbon Drive S150 46T	Shimano Nexus SG-C6000-8D 8-Speed	BSA 68 mm
Satori HL STEALTH 6 Dia. 31.8 mm	Gates Carbon Drive Polymer Ceramic 24	Satori HL Comet 31.6 mm	-
GHOST Low Rizer SQUARE 700 mm Rise 10 mm Dia. 31.8 mm	Shimano BR-M315 2/2 Piston 160 mm Disc	Justek 2059 HRN	S-M-L-XL
-	Continental Sport Contact II SL 37-622 // Continental Sport Contact II SL 37-622	GHOST SQUARE Urban Carrier	
-	Rodi Excalibur XC 622x19 mm 32H // Rodi Excalibur XC 622x19 mm 32H	GHOST RG40	

SIZE	ARTICLENUMBER	NOTES
SIZE S	18SU2007	
SIZE M	18SU2008	
SIZE L	18SU2009	
SIZE XL	18SU2010	



MODEL HIGHLIGHTS

- ▶ Shimano Nexus 8-speed hub drive
- ▶ High quality and reliability thanks to Gates Carbon drive belt

MODELL HIGHLIGHTS

- ▶ Shimano Nexus 8-Gang Nabe
- ▶ Zuverlässig und hochwertig: Gates Carbon Drive Riemenantrieb

SQUARE Urban AL	Shimano A1fine SL	Shimano HB-RM35 QR	16358
GHOST AL Rigid	Gates Carbon Drive S150 46T	Shimano Nexus SG-C6000-8D 8-Speed	BSA 68 mm
Satori HL STEALTH 6 Dia. 31.8 mm	Gates Carbon Drive Polymer Ceramic 24	Satori HL Comet 31.6 mm	-
GHOST Low Rizer SQUARE 700 mm Rise 10 mm Dia. 31.8 mm	Shimano BR-M315 2/2 Piston 160 mm Disc	Justek 2059 DRN	XS-S-M-L
-	Continental Sport Contact II SL 37-622 // Continental Sport Contact II SL 37-622	GHOST SQUARE Urban Carrier	
-	Rodi Excalibur XC 622x19 mm 32H // Rodi Excalibur XC 622x19 mm 32H	GHOST RG40	

SIZE	ARTICLENUMBER	NOTES
SIZE XS	18SU4007	
SIZE S	18SU4008	
SIZE M	18SU4009	
SIZE L	18SU4010	



FLAT // urban gray / tan / night black

28 AL **SQUARE** URBAN 3.8



MODEL HIGHLIGHTS

- ▶ High quality and reliability thanks to Gates Carbon drive belt
- ▶ SRAM Automatix 2-speed automatic gear hub
- ▶ Integrated rear carrier for pannier bags

MODELL HIGHLIGHTS

- ▶ Zuverlässig und hochwertig: Gates Carbon Drive Riemenantrieb
- ▶ Selbstschaltende SRAM Automatix 2-Gang Nabe
- ▶ Integrierter Seitentaschenträger

SQUARE Urban AL	-	Formula DC 20 QR	16358
GHOST AL Rigid	Gates Carbon Drive S150 46T	SRAM Automatix	BSA 68 mm
Satori HL STEALTH 6 Dia. 31.8 mm	Gates Carbon Drive Polymer Ceramic 24	Satori HL Comet 31.6 mm	-
GHOST Low Rizer SQUARE 700 mm Rise 10 mm Dia. 31.8 mm	Tektro HD-M285 2/2 Piston 160 mm Disc	Justek 2059 HRN	S-M-L-XL
-	Continental Sport Contact II SL 37-622 // Continental Sport Contact II SL 37-622	GHOST SQUARE Urban Carrier	
-	Rodi Excalibur XC 622x19 mm 32H // Rodi Excalibur XC 622x19 mm 32H	GHOST RG40	

SIZE	ARTICLENUMBER	NOTES
SIZE S	18SU2001	
SIZE M	18SU2002	
SIZE L	18SU2003	
SIZE XL	18SU2004	



MODEL HIGHLIGHTS

- ▶ High quality and reliability thanks to Gates Carbon drive belt
- ▶ SRAM Automatix 2-speed automatic gear hub
- ▶ Integrated rear carrier for pannier bags

MODELL HIGHLIGHTS

- ▶ Zuverlässig und hochwertig: Gates Carbon Drive Riemenantrieb
- ▶ Selbstschaltende SRAM Automatix 2-Gang Nabe
- ▶ Integrierter Seitentaschenträger

SQUARE Urban AL	-	Formula DC 20 QR	16358
GHOST AL Rigid	Gates Carbon Drive S150 46T	SRAM Automatix	BSA 68 mm
Satori HL STEALTH 6 Dia. 31.8 mm	Gates Carbon Drive Polymer Ceramic 24	Satori HL Comet 31.6 mm	-
GHOST Low Rizer SQUARE 700 mm Rise 10 mm Dia. 31.8 mm	Tektro HD-M285 2/2 Piston 160 mm Disc	Justek 2059 DRN	XS-S-M-L
-	Continental Sport Contact II SL 37-622 // Continental Sport Contact II SL 37-622	GHOST SQUARE Urban Carrier	
-	Rodi Excalibur XC 622x19 mm 32H // Rodi Excalibur XC 622x19 mm 32H	GHOST RG40	

SIZE	ARTICLENUMBER	NOTES
SIZE XS	18SU4001	
SIZE S	18SU4002	
SIZE M	18SU4003	
SIZE L	18SU4004	

SQUARE^{CROSS X}

ALL THE ADVANTAGES OF THE SQUARE PLATFORM // ALLE VORTEILE DER SQUARE-PLATTFORM 



 WITH LIGHTS AND FENDERS // MIT LICHT UND SCHUTZBLECHEN

// CROSS / LEISURE

FEATURES



CHARACTERISTICS

- ▶ Athletic look and drive: mountain bike origins
- ▶ Suspension forks for athletic operation also in easy terrain
- ▶ With quick-mount fenders

CHARAKTERISTIK

- ▶ Sportiver Look und Antrieb: Wurzeln beim Mountainbike
- ▶ Federgabeln für sportiven Einsatz auch in leichtem Gelände
- ▶ Mit Steckschutzblechen

TARGET GROUP

- ▶ For all riders looking to combine a suitable training tool with a great means of transport in all kinds of weather

ZIELGRUPPE

- ▶ Für alle, die Trainingsgerät und wettertaugliches Alltagsrad verbinden möchten



SQUARE^{CROSS X}

// GEOMETRY AND DATA CHARTS / GEOMETRIE UND TECHNISCHE DATEN

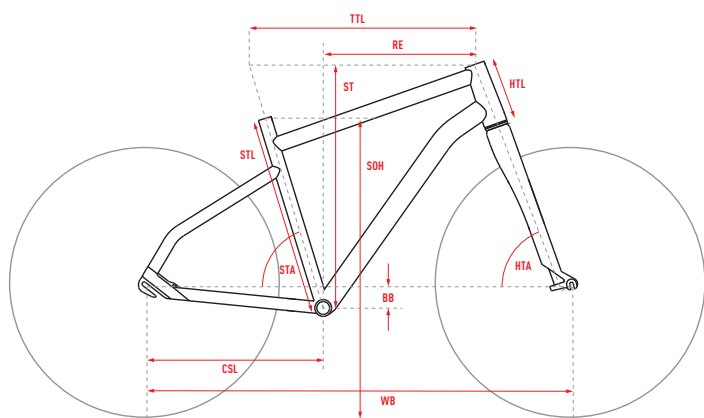

ALL DIMENSIONS IN MM (EXCEPT HTA AND STA IN °)

ALLE MASSE IN MM (AUSNAHME HTA UND STA IN °)

- STL** SEAT TUBE LENGTH
SITZROHRLÄNGE
- CSL** CHAINSTAY LENGTH
KETTENSTREBENLÄNGE
- TTL** TOP TUBE LENGTH
OBERROHRLÄNGE
- HTL** HEADTUBE LENGTH
STEUERROHRLÄNGE
- HTA** HEADTUBE ANGLE
STEUERROHRWINKEL
- STA** SEATTUBE ANGLE
SITZROHRWINKEL
- BB** BB DROP
TRETLAGERABSENKUNG
- WB** WHEELBASE
RADSTAND
- ST** STACK
STACK
- RE** REACH
REACH
- SOH** STANDOVER HEIGHT
ÜBERSTANDSHÖHE
- Head Set Diameter (Upper / Lower)**
STEUERSATZDURCHMESSER (OBEN / UNTEN)
- Axle Standard (Rear / Front)**
ACHSENSTANDARD (HINTEN / VORNE)
- Bottom Bracket Standard**
TRETLAGERSTANDARD
- Seat Post Diameter**
SITZELSTÜTZENDURCHMESSER
- Shock Hardware (Ø 8mm)**
DÄMPFERBUCHSENMASSE (Ø 8MM)
- Shock Length**
DÄMPFEREINBAULÄNGE
- Shock Travel**
DÄMPFERHUB
- Front Fork Travel**
FEDERWEG VORNE
- Rear Wheel Travel**
FEDERWEG HINTEN
- Min Saddle Height**
MIN SÄTTELHÖHE
- Max Saddle Height**
MAX SÄTTELHÖHE
- Min Inseam**
MIN SCHRITTLÄNGE
- Max Inseam**
MAX SCHRITTLÄNGE
- Stem Length**
VORBAULÄNGE
- Handlebar Width**
LENKERBREITE
- Crank Length**
KURBELLÄNGE
- Seat Tube Bottle Mount**
FLASCHE SÄTTELROHR
- Down Tube Bottle Mount**
FLASCHE UNTERROHR

STL CSL TTL HTL HTA STA BB WB ST RE SOH

SQUARE CROSS X5.8 AL U

	S	M	L	XL
STL	470	455	580	160
CSL	470	455	595	165
TTL	580	610	185	71
HTL	70	71	72	71
HTA	73.5	72.5	72.5	72
STA	73.5	72.5	72	72
BB	60	60	60	60
WB	1105	1112	1121	1121
ST	636	664	683	683
RE	391	400	403	403
SOH	735	815	855	855
Head Set Diameter (Upper / Lower)	ZS44/ZS56	ZS44/ZS56	ZS44/ZS56	ZS44/ZS56
Axle Standard (Rear / Front)	135/100	135/100	135/100	135/100
Bottom Bracket Standard	BSA 68	BSA 68	BSA 68	BSA 68
Seat Post Diameter	31.6	31.6	31.6	31.6
Shock Hardware (Ø 8mm)	/	/	/	/
Shock Length	/	/	/	/
Shock Travel	60	60	60	60
Front Fork Travel	/	/	/	/
Rear Wheel Travel	80	80	80	80
Min Saddle Height	170	170	170	170
Max Saddle Height	170	170	170	170
Min Inseam	0.75	0.75	0.75	0.75
Max Inseam	0.75	0.75	0.75	0.75
Stem Length	0.75	0.75	0.75	0.75
Handlebar Width	0.75	0.75	0.75	0.75
Crank Length	0.75	0.75	0.75	0.75
Seat Tube Bottle Mount	0.75	0.75	0.75	0.75
Down Tube Bottle Mount	0.75	0.75	0.75	0.75

SQUARE CROSS X5.8 AL W

	XS	S	M	L
STL	420	455	560	150
CSL	420	455	575	155
TTL	560	610	170	70.5
HTL	70.5	72	72	72
HTA	73	72	72	72
STA	73	72	72	72
BB	60	60	60	60
WB	1073	1091	1112	1112
ST	629	648	662	662
RE	368	379	395	395
SOH	630	625	625	625
Head Set Diameter (Upper / Lower)	ZS44/ZS56	ZS44/ZS56	ZS44/ZS56	ZS44/ZS56
Axle Standard (Rear / Front)	135/100	135/100	135/100	135/100
Bottom Bracket Standard	BSA 68	BSA 68	BSA 68	BSA 68
Seat Post Diameter	31.6	31.6	31.6	31.6
Shock Hardware (Ø 8mm)	/	/	/	/
Shock Length	/	/	/	/
Shock Travel	60	60	60	60
Front Fork Travel	/	/	/	/
Rear Wheel Travel	80	80	80	80
Min Saddle Height	170	170	170	170
Max Saddle Height	170	170	170	170
Min Inseam	0.75	0.75	0.75	0.75
Max Inseam	0.75	0.75	0.75	0.75
Stem Length	0.75	0.75	0.75	0.75
Handlebar Width	0.75	0.75	0.75	0.75
Crank Length	0.75	0.75	0.75	0.75
Seat Tube Bottle Mount	0.75	0.75	0.75	0.75
Down Tube Bottle Mount	0.75	0.75	0.75	0.75

SQUARE CROSS X3.8 AL U

	S	M	L	XL
STL	470	455	580	160
CSL	470	455	595	165
TTL	580	610	185	71
HTL	70	71	72	71
HTA	73.5	72.5	72.5	72
STA	73.5	72.5	72	72
BB	60	60	60	60
WB	1105	1112	1121	1121
ST	636	664	683	683
RE	391	400	403	403
SOH	735	815	855	855
Head Set Diameter (Upper / Lower)	ZS44/ZS56	ZS44/ZS56	ZS44/ZS56	ZS44/ZS56
Axle Standard (Rear / Front)	135/100	135/100	135/100	135/100
Bottom Bracket Standard	BSA 68	BSA 68	BSA 68	BSA 68
Seat Post Diameter	31.6	31.6	31.6	31.6
Shock Hardware (Ø 8mm)	/	/	/	/
Shock Length	/	/	/	/
Shock Travel	50	50	50	50
Front Fork Travel	/	/	/	/
Rear Wheel Travel	75	75	75	75
Min Saddle Height	170	170	170	170
Max Saddle Height	170	170	170	170
Min Inseam	0.75	0.75	0.75	0.75
Max Inseam	0.75	0.75	0.75	0.75
Stem Length	0.75	0.75	0.75	0.75
Handlebar Width	0.75	0.75	0.75	0.75
Crank Length	0.75	0.75	0.75	0.75
Seat Tube Bottle Mount	0.75	0.75	0.75	0.75
Down Tube Bottle Mount	0.75	0.75	0.75	0.75

SQUARE CROSS X3.8 AL W

	XS	S	M	L
STL	420	455	560	150
CSL	420	455	575	155
TTL	560	610	170	70.5
HTL	70.5	72	72	72
HTA	73	72	72	72
STA	73	72	72	72
BB	60	60	60	60
WB	1073	1091	1112	1112
ST	629	648	662	662
RE	368	379	395	395
SOH	630	625	625	625
Head Set Diameter (Upper / Lower)	ZS44/ZS56	ZS44/ZS56	ZS44/ZS56	ZS44/ZS56
Axle Standard (Rear / Front)	135/100	135/100	135/100	135/100
Bottom Bracket Standard	BSA 68	BSA 68	BSA 68	BSA 68
Seat Post Diameter	31.6	31.6	31.6	31.6
Shock Hardware (Ø 8mm)	/	/	/	/
Shock Length	/	/	/	/
Shock Travel	50	50	50	50
Front Fork Travel	/	/	/	/
Rear Wheel Travel	75	75	75	75
Min Saddle Height	170	170	170	170
Max Saddle Height	170	170	170	170
Min Inseam	0.75	0.75	0.75	0.75
Max Inseam	0.75	0.75	0.75	0.75
Stem Length	0.75	0.75	0.75	0.75
Handlebar Width	0.75	0.75	0.75	0.75
Crank Length	0.75	0.75	0.75	0.75
Seat Tube Bottle Mount	0.75	0.75	0.75	0.75
Down Tube Bottle Mount	0.75	0.75	0.75	0.75



FLAT // titanium gray / microchip gray / neon green

28 AL **SQUARE** CROSS X 5.8



MODEL HIGHLIGHTS

- ▶ Shimano hub dynamo
- ▶ Axa lighting system and SKS fenders
- ▶ Shimano Deore drivetrain

MODELL HIGHLIGHTS

- ▶ Shimano Nabendynamo
- ▶ Axa Beleuchtung und SKS Schutzbleche
- ▶ Shimano Deore Schaltgruppe

SQUARE Cross AL	Shimano Deore SL-M6000	Shimano Hub Dynamo DH-3032-QR	Axa Blueline 30
RST Nova MLO 60 mm	Shimano FC-T521 48-36-26	Formula DC 22 QR	Axa Blueline
Satori HL STEALTH 6 Dia. 31.8 mm	Shimano CS-HG500-10 11-34	Satori HL Comet 31.6 mm	14106
GHOST Low Rizer SQUARE 680 mm Rise 15 mm Dia. 31.8 mm	Tektro HD-M285 2/2 Piston 160 mm Disc	Justek 3050 HRN	BSA 68 mm
Shimano Deore RD-M6000 Shadow Plus 10-S	Schwalbe CX Comp SBC 40-622 // Schwalbe CX Comp SBC 40-622	SKS PETA 51.28"	EZ1954
Shimano Deore FD-T6000	Rodi Excalibur XC 622x19 mm 32H // Rodi Excalibur XC 622x19 mm 32H	Pletscher	S-M-L-XL

SIZE	ARTICLENUMBER	NOTES
SIZE S	18SC1043	
SIZE M	18SC1044	
SIZE L	18SC1045	
SIZE XL	18SC1046	



MODEL HIGHLIGHTS

- ▶ Shimano hub dynamo
- ▶ Axa lighting system and SKS fenders
- ▶ Shimano Deore drivetrain

MODELL HIGHLIGHTS

- ▶ Shimano Nabendynamo
- ▶ Axa Beleuchtung und SKS Schutzbleche
- ▶ Shimano Deore Schaltgruppe

SQUARE Cross AL	Shimano Deore SL-M6000	Shimano Hub Dynamo DH-3032-OR	Axa Blueline 30
RST Nova MLO 60 mm	Shimano FC-T521 48-36-26	Formula DC 22 QR	Axa Blueline
Satori HL STEALTH 6 Dia. 31.8 mm	Shimano CS-HG500-10 11-34	Satori HL Comet 31.6 mm	14106
GHOST Low Rizer SQUARE 680 mm Rise 15 mm Dia. 31.8 mm	Tektro HD-M285 2/2 Piston 160 mm Disc	Justek 3050 DRN	BSA 68 mm
Shimano Deore RD-M6000 Shadow Plus 10-S	Schwalbe CX Comp SBC 40-422 // Schwalbe CX Comp SBC 40-422	SKS PET A 51.28"	EZ1954
Shimano Deore FD-T6000	Rodi Excalibur XC 622x19 mm 32H // Rodi Excalibur XC 622x19 mm 32H	Pletscher	XS-S-M-L

SIZE	ARTICLENUMBER	NOTES
SIZE XS	18SC3043	
SIZE S	18SC3044	
SIZE M	18SC3045	
SIZE L	18SC3046	



FLAT // palladium silver / iridium silver / vibrant blue

28 AL **SQUARE** CROSS X 3.8



MODEL HIGHLIGHTS

- ▶ With quick mount fenders and lighting system
- ▶ New Shimano Altus 9-speed group
- ▶ Color option available

MODELL HIGHLIGHTS

- ▶ Mit Steckschutzblechen und Licht
- ▶ Neue Shimano Altus 9-Gang-Schaltgruppe
- ▶ Mit Farboption

SQUARE Cross AL	Shimano Altus SL-M2000	Shimano Hub Dynamo DH-3032-QR	Spanninga Brio XDO
SR Suntour SF16 NEX DS-700C 50 mm	Shimano FC-M371 48-36-26	Formula DC 22 QR	Spanninga Vivo XDS
GHOST SQUARE Dia. 31.8 mm	Shimano CS-HG-200-9 11-34	GHOST SP-DC1 31.6 mm	14106
GHOST Low Rizer SQUARE 680 mm Rise 15 mm Dia. 31.8 mm	Tektro HD-M285 2/2 Piston 160 mm Disc	Justek 3050 HRN	BSA 68 mm
Shimano Altus RD-M2000 9-S Shadow Design	Schwalbe CX Comp SBC 40-622 // Schwalbe CX Comp SBC 40-622	SKS PETA 51.28"	EZ1954
Shimano Altus FD-M370	Rodi Excalibur XC 622x19 mm 32H // Rodi Excalibur XC 622x19 mm 32H	Pletscher	S-M-L-XL

SIZE	ARTICLENUMBER	NOTES
SIZE S	18SC1031	
SIZE M	18SC1032	
SIZE L	18SC1033	
SIZE XL	18SC1034	



MODEL HIGHLIGHTS

- ▶ With quick mount fenders and lighting system
- ▶ New Shimano Altus 9-speed group
- ▶ Color option available

MODELL HIGHLIGHTS

- ▶ Mit Steckschutzblechen und Licht
- ▶ Neue Shimano Altus 9-Gang-Schaltgruppe
- ▶ Mit Farboption

SQUARE Cross AL	Shimano Altus SL-M2000	Shimano Hub Dynamo DH-3D32-OR	Spanninga Brio X00
SR Suntour SF16 NEX DS-700C 50 mm	Shimano FC-M371 48-36-26	Formula DC 22 QR	Spanninga Vivo XDS
GHOST SQUARE Dia. 31.8 mm	Shimano CS-HG-200-9 11-34	GHOST SP-DC1 31.6 mm	14106
GHOST Low Rizer Square 680 mm Rise 15 mm Dia. 31.8 mm	Tektro HD-M285 2/2 Piston 160 mm Disc	Justek 3050 DRN	BSA 68 mm
Shimano Altus RD-M2000 9-S Shadow Design	Schwalbe CX Comp SBC 40-622 // Schwalbe CX Comp SBC 40-622	SKS PET A 51.28"	EZ1954
Shimano Altus FD-M370	Rodi Excalibur XC 622x19 mm 32H // Rodi Excalibur XC 622x19 mm 32H	Pletscher	XS-S-M-L

SIZE	ARTICLENUMBER	NOTES
SIZE XS	18SC3031	
SIZE S	18SC3032	
SIZE M	18SC3033	
SIZE L	18SC3034	



FLAT // night black / titanium gray / neon yellow

28 AL **SQUARE** CROSS X 3.8



MODEL HIGHLIGHTS

- ▶ With quick mount fenders and lighting system
- ▶ New Shimano Altus 9-speed group
- ▶ Color option available

MODELL HIGHLIGHTS

- ▶ Mit Steckschutzblechen und Licht
- ▶ Neue Shimano Altus 9-Gang-Schaltgruppe
- ▶ Mit Farboption

SQUARE Cross AL	Shimano Altus SL-M2000	Shimano Hub Dynamo DH-3032-QR	Spanninga Brio XDO
SR Suntour SF16 NEX DS-700C 50 mm	Shimano FC-M371 48-36-26	Formula DC 22 QR	Spanninga Vivo XDS
GHOST SQUARE Dia. 31.8 mm	Shimano CS-HG-200-9 11-34	GHOST SP-DC1 31.6 mm	14106
GHOST Low Rizer SQUARE 680 mm Rise 15 mm Dia. 31.8 mm	Tektro HD-M285 2/2 Piston 160 mm Disc	Justek 3050 HRN	BSA 68 mm
Shimano Altus RD-M2000 9-S Shadow Design	Schwalbe CX Comp SBC 40-622 // Schwalbe CX Comp SBC 40-622	SKS PETA 51.28"	EZ1954
Shimano Altus FD-M370	Rodi Excalibur XC 622x19 mm 32H // Rodi Excalibur XC 622x19 mm 32H	Pletscher	S-M-L-XL

SIZE	ARTICLENUMBER	NOTES
SIZE S	18SC1037	
SIZE M	18SC1038	
SIZE L	18SC1039	
SIZE XL	18SC1040	



MODEL HIGHLIGHTS

- ▶ With quick mount fenders and lighting system
- ▶ New Shimano Altus 9-speed group
- ▶ Color option available

MODELL HIGHLIGHTS

- ▶ Mit Steckschutzblechen und Licht
- ▶ Neue Shimano Altus 9-Gang-Schaltgruppe
- ▶ Mit Farboption

SQUARE Cross AL	Shimano Altus SL-M2000	Shimano Hub Dynamo DH-3D32-QR	Spanninga Brio X00
SR Suntour SF16 NEX DS-700C 50 mm	Shimano FC-M371 48-36-26	Formula DC 22 QR	Spanninga Vivo XDS
GHOST SQUARE Dia. 31.8 mm	Shimano CS-HG-200-9 11-34	GHOST SP-DC1 31.6 mm	14106
GHOST Low Rizer SQUARE 680 mm Rise 15 mm Dia. 31.8 mm	Tektro HD-M285 2/2 Piston 160 mm Disc	Justek 3050 DRN	BSA 68 mm
Shimano Altus RD-M2000 9-S Shadow Design	Schwalbe CX Comp SBC 40-622 // Schwalbe CX Comp SBC 40-622	SKS PET A 51.28"	EZ1954
Shimano Altus FD-M370	Rodi Excalibur XC 622x19 mm 32H // Rodi Excalibur XC 622x19 mm 32H	Pletscher	XS-S-M-L

SIZE	ARTICLENUMBER	NOTES
SIZE XS	18SC3037	
SIZE S	18SC3038	
SIZE M	18SC3039	
SIZE L	18SC3040	

SQUARE^{CROSS}



+ FAST FITNESS BIKE FOR EASY OFF-ROAD TERRAIN //
SCHNELLES FITNESSBIKE FÜR LEICHTES OFFROAD-TERRAIN

+ ALL THE ADVANTAGES OF THE SQUARE PLATFORM //
ALLE VORTEILE DER SQUARE-PLATTFORM

+ CLEAN CABLE ROUTING WITH EASY ACCESS //
SAUBERE ZUGVERLEGUNG MIT LEICHTEM ZUGANG

// CROSS / FITNESS

FEATURES



CHARACTERISTICS

- ▶ Athletic look and drive: definite mountain bike roots
- ▶ Suspension forks for athletic operation also in easy terrain

CHARAKTERISTIK

- ▶ Sportiver Look und Antrieb: Wurzeln beim Mountainbike
- ▶ Federgabeln für sportiven Einsatz auch in leichtem Gelände

TARGET GROUP

- ▶ Versatile fitness bike for occasional riders and teenagers

ZIELGRUPPE

- ▶ Vielfältiges Fitnessrad für Gelegenheitsfahrer und Jugendliche



SQUARE^{CROSS}

// GEOMETRY AND DATA CHARTS / GEOMETRIE UND TECHNISCHE DATEN

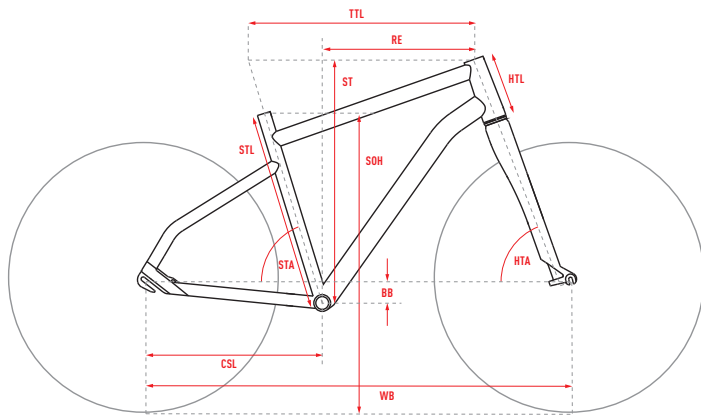

ALL DIMENSIONS IN MM (EXCEPT HTA AND STA IN °)

ALLE MASSE IN MM (AUSNAHME HTA UND STA IN °)

- STL** SEAT TUBE LENGTH
SITZROHRLÄNGE
- CSL** CHAINSTAY LENGTH
KETTENSTREBELÄNGE
- TTL** TOP TUBE LENGTH
OBERROHRLÄNGE
- HTL** HEADTUBE LENGTH
STEUERROHRLÄNGE
- HTA** HEADTUBE ANGLE
STEUERROHRWINKEL
- STA** SEATTUBE ANGLE
SITZROHRWINKEL
- BB** BB DROP
TRETLAGERABSENKUNG
- WB** WHEELBASE
RADSTAND
- ST** STACK
STACK
- RE** REACH
REACH
- SOH** STANDOVER HEIGHT
ÜBERSTANDSHÖHE
- HD** HEAD SET DIAMETER (UPPER / LOWER)
STEUERSATZDURCHMESSER (OBEN / UNTEN)
- AS** AXLE STANDARD (REAR / FRONT)
ACHSENSTANDARD (HINTEN / VORNE)
- BS** BOTTOM BRACKET STANDARD
TRETLAGERSTANDARD
- SD** SEAT POST DIAMETER
SITTELSTÜTZENDURCHMESSER
- SH** SHOCK HARDWARE (Ø 8MM)
DÄMPFERBUCHSENMASSE (Ø 8MM)
- SL** SHOCK LENGTH
DÄMPFEREINBAULÄNGE
- ST** SHOCK TRAVEL
DÄMPFERHUB
- FF** FRONT FORK TRAVEL
FEDERWEG VORNE
- FR** REAR WHEEL TRAVEL
FEDERWEG HINTEN
- MS** MIN SADDLE HEIGHT
MIN SÄTTELHÖHE
- MX** MAX SADDLE HEIGHT
MAX SÄTTELHÖHE
- MI** MIN INSEAM
MIN SCHRITTLÄNGE
- MX** MAX INSEAM
MAX SCHRITTLÄNGE
- SL** STEM LENGTH
VORBAULÄNGE
- HW** HANDLEBAR WIDTH
LENKERBREITE
- CL** CRANK LENGTH
KURBELLENGE
- SB** SEATTUBE BOTTLE MOUNT
FLASCHE SÄTTELROHR
- DU** DOWNTUBE BOTTLE MOUNT
FLASCHE UNTERROHR

STL CSL TTL HTL HTA STA BB WB ST RE SOH

SQUARE CROSS 7.8 AL U

	S	M	L	XL
STL	470	455	580	160
CSL	470	455	595	165
TTL	570	455	610	185
HTL	620	455	625	205
HTA	70	70	71	71
STA	73.5	72.5	72.5	72
BB	60	60	60	60
WB	1105	1108	1112	1121
ST	636	641	664	683
RE	391	393	400	403
SOH	735	770	815	855
HD	ZS44/ZS56	ZS44/ZS56	ZS44/ZS56	ZS44/ZS56
AS	135/100	135/100	135/100	135/100
BS	BSA 68	BSA 68	BSA 68	BSA 68
SD	31.6	31.6	31.6	31.6
SH	/	/	/	/
SL	/	/	/	/
ST	65	65	65	65
FF	/	/	/	/
FR	80	80	80	80
MS	170	170	170	170
MX	0.75	0.75	0.75	0.75
MI	0.75	0.75	0.75	0.75
MX	0.75	0.75	0.75	0.75
SL	0.75	0.75	0.75	0.75
HW	80	80	80	80
CL	170	170	170	170
SB	0.75	0.75	0.75	0.75
DU	0.75	0.75	0.75	0.75

SQUARE CROSS 7.8 AL W

	XS	S	M	L
STL	420	455	560	150
CSL	420	455	575	155
TTL	470	455	590	170
HTL	520	455	590	170
HTA	70.5	70.5	70.5	70.5
STA	73	72	72	72
BB	60	60	60	60
WB	1073	1076	1091	1112
ST	629	634	648	662
RE	368	369	379	395
SOH	630	625	625	625
HD	ZS44/ZS56	ZS44/ZS56	ZS44/ZS56	ZS44/ZS56
AS	135/100	135/100	135/100	135/100
BS	BSA 68	BSA 68	BSA 68	BSA 68
SD	31.6	31.6	31.6	31.6
SH	/	/	/	/
SL	/	/	/	/
ST	65	65	65	65
FF	/	/	/	/
FR	80	80	80	80
MS	170	170	170	170
MX	0.75	0.75	0.75	0.75
MI	0.75	0.75	0.75	0.75
MX	0.75	0.75	0.75	0.75
SL	0.75	0.75	0.75	0.75
HW	80	80	80	80
CL	170	170	170	170
SB	0.75	0.75	0.75	0.75
DU	0.75	0.75	0.75	0.75

SQUARE CROSS 6.8 AL U

	S	M	L	XL
STL	470	455	580	160
CSL	470	455	595	165
TTL	570	455	610	185
HTL	620	455	625	205
HTA	70	70	71	71
STA	73.5	72.5	72.5	72
BB	60	60	60	60
WB	1105	1108	1112	1121
ST	636	641	664	683
RE	391	393	400	403
SOH	735	770	815	855
HD	ZS44/ZS56	ZS44/ZS56	ZS44/ZS56	ZS44/ZS56
AS	135/100	135/100	135/100	135/100
BS	BSA 68	BSA 68	BSA 68	BSA 68
SD	31.6	31.6	31.6	31.6
SH	/	/	/	/
SL	/	/	/	/
ST	60	60	60	60
FF	/	/	/	/
FR	80	80	80	80
MS	170	170	170	170
MX	0.75	0.75	0.75	0.75
MI	0.75	0.75	0.75	0.75
MX	0.75	0.75	0.75	0.75
SL	0.75	0.75	0.75	0.75
HW	80	80	80	80
CL	170	170	170	170
SB	0.75	0.75	0.75	0.75
DU	0.75	0.75	0.75	0.75

SQUARE CROSS 6.8 AL W

	XS	S	M	L
STL	420	455	560	150
CSL	420	455	575	155
TTL	470	455	590	170
HTL	520	455	590	170
HTA	70.5	70.5	70.5	70.5
STA	73	72	72	72
BB	60	60	60	60
WB	1073	1076	1091	1112
ST	629	634	648	662
RE	368	369	379	395
SOH	630	625	625	625
HD	ZS44/ZS56	ZS44/ZS56	ZS44/ZS56	ZS44/ZS56
AS	135/100	135/100	135/100	135/100
BS	BSA 68	BSA 68	BSA 68	BSA 68
SD	31.6	31.6	31.6	31.6
SH	/	/	/	/
SL	/	/	/	/
ST	60	60	60	60
FF	/	/	/	/
FR	80	80	80	80
MS	170	170	170	170
MX	0.75	0.75	0.75	0.75
MI	0.75	0.75	0.75	0.75
MX	0.75	0.75	0.75	0.75
SL	0.75	0.75	0.75	0.75
HW	80	80	80	80
CL	170	170	170	170
SB	0.75	0.75	0.75	0.75
DU	0.75	0.75	0.75	0.75

SQUARE CROSS 4.8 / 2.8 / 1.8 AL U

	S	M	L	XL
STL	470	455	580	160
CSL	470	455	595	165
TTL	570	455	610	185
HTL	620	455	625	205
HTA	70	70	71	71
STA	73.5	72.5	72.5	72
BB	60	60	60	60
WB	1105	1108	1112	1121
ST	636	641	664	683
RE	391	393	400	403
SOH	735	770	815	855
HD	ZS44/ZS56	ZS44/ZS56	ZS44/ZS56	ZS44/ZS56
AS	135/100	135/100	135/100	135/100
BS	BSA 68	BSA 68	BSA 68	BSA 68
SD	31.6	31.6	31.6	31.6
SH	/	/	/	/
SL	/	/	/	/
ST	50	50	50	50
FF	/	/	/	/
FR	75	75	75	75
MS	170	170	170	170
MX	0.75	0.75	0.75	0.75
MI	0.75	0.75	0.75	0.75
MX	0.75	0.75	0.75	0.75
SL	0.75	0.75	0.75	0.75
HW	75	75	75	75
CL	170	170	170	170
SB	0.75	0.75	0.75	0.75
DU	0.75	0.75	0.75	0.75

SQUARE CROSS 4.8 / 2.8 / 1.8 AL W

	XS	S	M	L
STL	420	455	560	150
CSL	420	455	575	155
TTL	470	455	590	170
HTL	520	455	590	170
HTA	70.5	70.5	70.5	70.5
STA	73	72	72	72
BB	60	60	60	60
WB	1073	1076	1091	1112
ST	629	634	648	662
RE	368	369	379	395
SOH	630	625	625	625
HD	ZS44/ZS56	ZS44/ZS56	ZS44/ZS56	ZS44/ZS56
AS	135/100	135/100	135/100	135/100
BS	BSA 68	BSA 68	BSA 68	BSA 68
SD	31.6	31.6	31.6	31.6
SH	/	/	/	/
SL	/	/	/	/
ST	50	50	50	50
FF	/	/	/	/
FR	75	75	75	75
MS	170	170	170	170
MX	0.75	0.75	0.75	0.75
MI	0.75	0.75	0.75	0.75
MX	0.75	0.75	0.75	0.75
SL	0.75	0.75	0.75	0.75
HW	75	75	75	75
CL	170	170	170	170
SB	0.75	0.75	0.75	0.75
DU	0.75	0.75	0.75	0.75



FLAT // night black / titanium gray / neon red

28 AL **SQUARE** CROSS 7.8



MODEL HIGHLIGHTS

- ▶ High quality Rock Shox Paragon fork
- ▶ Shimano XT brakes
- ▶ Schwalbe Smart Sam Performance Addix tires

MODELL HIGHLIGHTS

- ▶ Hochwertige Rock Shox Paragon Federgabel
- ▶ Shimano XT Bremsen
- ▶ Schwalbe Smart Sam Performance Addix Bereifung

SQUARE Cross AL	Shimano Deore FD-T6000	Schwalbe Smart Sam Performance Addix 44-622 // Schwalbe Smart Sam Performance Addix 44-622	Justek 3050 HRN
Rock Shox Paragon Gold RL Solo Air 65 mm	Shimano XT SL-M780	Rodi Excalibur XC 622x19 mm 32H // Rodi Excalibur XC 622x19 mm 32H	14358
Satori HL STEALTH 6 Dia. 31.8 mm	Shimano XT FC-T781 48-36-26	Shimano XT HB-M8000 DR	BSA 68 mm
Satori Deviant Bow 680 mm Rise 12 mm Dia. 31.8 mm	Shimano CS-HG500-10 11-34	Shimano XT FH-M8000 DR	EZ1954
Shimano XT RD-M781 10-S Shadow Design	Shimano XT BR-M8000 2/2 Piston 180 mm Disc	Satori HL Comet 31.6 mm	S-M-L-XL

SIZE	ARTICLENUMBER	NOTES
SIZE S	18SC2007	
SIZE M	18SC2008	
SIZE L	18SC2009	
SIZE XL	18SC2010	



MODEL HIGHLIGHTS

- ▶ High quality Rock Shox Paragon fork
- ▶ Shimano XT brakes
- ▶ Schwalbe Smart Sam Performance Addix tires

MODELL HIGHLIGHTS

- ▶ Hochwertige Rock Shox Paragon Federgabel
- ▶ Komplette XT Ausstattung inklusive Bremsen
- ▶ Schwalbe Smart Sam Performance Addix Bereifung

SQUARE Cross AL	Shimano Deore FD-T6000	Schwalbe Smart Sam Performance Addix 44-622 // Schwalbe Smart Sam Performance Addix 44-622	Justek 3050 DRN
Rock Shox Paragon Gold RL Solo Air 65 mm	Shimano XT SL-M780	Rodi Excalibur XC 622x19 mm 32H // Rodi Excalibur XC 622x19 mm 32H	16358
Satori HL STEALTH 6 Dia. 31.8 mm	Shimano XT FC-1781 48-36-26	Shimano XT HB-M8000 QR	BSA 68 mm
Satori Deviant Bow 680 mm Rise 12 mm Dia. 31.8 mm	Shimano CS-HG500-10 11-34	Shimano XT FH-M8000 QR	EZ1954
Shimano XT RD-M781 10-S Shadow Design	Shimano XT BR-M8000 2/2 Piston 180 mm Disc	Satori HL Comet 31.6 mm	XS-S-M-L

SIZE	ARTICLENUMBER	NOTES
SIZE XS	18SC4007	
SIZE S	18SC4008	
SIZE M	18SC4009	
SIZE L	18SC4010	



FLAT // titanium gray / microchip gray / neon yellow

28 AL **SQUARE** CROSS 6.8



MODEL HIGHLIGHTS

- ▶ SRAM Level disc brakes
- ▶ SRAM NX 1x11-drivetrain
- ▶ Hassle free sports bike

MODELL HIGHLIGHTS

- ▶ SRAM Level Scheibenbremsen
- ▶ SRAM NX 1x11-Antrieb
- ▶ Sorgenfreies Sportbike

SQUARE Cross AL	-	Continental Speed RIDE 42-622 // Continental Speed RIDE 42-622	Justek 3050 HRN
RST ViV Air TNL 60 mm	SRAM NX	Rodi Excalibur XC 622x19 mm 32H // Rodi Excalibur XC 622x19 mm 32H	14358
Satori HL STEALTH 6 Dia. 31.8 mm	SRAM NX.X-Sync 38T	Formula DC 20 QR	BSA 68 mm
Satori Deviant Bow 680 mm Rise 12 mm Dia. 31.8 mm	SRAM PG-1130 11-42	Formula DC 22 QR	EZ1954
SRAM NX 11-S	SRAM Level 2/2 Piston 160 mm Disc	Satori HL Comet 31.6 mm	S-M-L-XL

SIZE	ARTICLENUMBER	NOTES
SIZE S	18SC5001	
SIZE M	18SC5002	
SIZE L	18SC5003	
SIZE XL	18SC5004	



MODEL HIGHLIGHTS

- ▶ SRAM Level disc brakes
- ▶ SRAM NX 1x11-drivetrain
- ▶ Hassle free sports bike

MODELL HIGHLIGHTS

- ▶ SRAM Level Scheibenbremsen
- ▶ SRAM NX 1x11-Antrieb
- ▶ Sorgenfreies Sportbike

SQUARE Cross AL	-	Continental Speed RIDE 42-622 // Continental Speed RIDE 42-622	Justek 3050 DRN
RST VIV Air TNL 60 mm	SRAM NX	Rodi Excalibur XC 622x19 mm 32H // Rodi Excalibur XC 622x19 mm 32H	16350
Satori HL STEALTH 6 Dia. 31.8 mm	SRAM NX X-Sync 38T	Formula DC 20 QR	BSA 68 mm
Satori Deviant Bow 680 mm Rise 12 mm Dia. 31.8 mm	SRAM PG-1130 11-42	Formula DC 22 QR	EZ1954
SRAM NX 11-S	SRAM Level 2/2 Piston 160 mm Disc	Satori HL Comet 31.6 mm	XS-S-M-L

SIZE	ARTICLENUMBER	NOTES
SIZE XS	18SC6001	
SIZE S	18SC6002	
SIZE M	18SC6003	
SIZE L	18SC6004	



FLAT // titanium gray / microchip gray / neon red

28 AL **SQUARE** CROSS 4.8



MODEL HIGHLIGHTS

- ▶ Suntour suspension fork
- ▶ Shimano Deore 10-speed drivetrain

MODELL HIGHLIGHTS

- ▶ Suntour Federgabel
- ▶ Shimano Deore 10-fach-Gruppe

SQUARE Cross AL	Shimano Deore FD-T6000	Continental Speed RIDE 42-622 // Continental Speed RIDE 42-622	Justek 3050 HRN
SR Suntour SF16 NEX HLO-DS 50 mm	Shimano Deore SL-M6000	Rodi Excalibur XC 622x19 mm 32H // Rodi Excalibur XC 622x19 mm 32H	14106
Satori HL STEALTH 6 Dia. 31.8 mm	Shimano FC-T521 48-36-26	Formula DC 20 QR	BSA 68 mm
Satori Deviant Bow 680 mm Rise 12 mm Dia. 31.8 mm	Shimano CS-HG500-10 11-34	Formula DC 22 QR	EZ1954
Shimano Deore RD-M6000 Shadow Plus 10-S	Tektro HD-M285 2/2 Piston 160 mm Disc	Satori HL Comet 31.6 mm	S-M-L-XL

SIZE	ARTICLENUMBER	NOTES
SIZE S	18SC1025	
SIZE M	18SC1026	
SIZE L	18SC1027	
SIZE XL	18SC1028	



MODEL HIGHLIGHTS

- ▶ Suntour suspension fork
- ▶ Shimano Deore 10-speed drivetrain

MODELL HIGHLIGHTS

- ▶ Suntour Federgabel
- ▶ Shimano Deore 10-fach-Gruppe

SQUARE Cross AL	Shimano Deore FD-T6000	Continental Speed RIDE 42-622 // Continental Speed RIDE 42-622	Justek 3050 DRN
SR Suntour SF16 NEX HLO-DS 50 mm	Shimano Deore SL-M6000	Rodi Excalibur XC 622x19 mm 32H // Rodi Excalibur XC 622x19 mm 32H	14106
Satori HL STEALTH 6 Dia. 31.8 mm	Shimano FC-T521 48-36-26	Formula DC 20 QR	BSA 68 mm
Satori Deviant Bow 680 mm Rise 12 mm Dia. 31.8 mm	Shimano CS-HG500-10 11-34	Formula DC 22 QR	EZ1954
Shimano Deore RD-M6000 Shadow Plus 10-S	Tektro HD-M285 2/2 Piston 160 mm Disc	Satori HL Comet 31.6 mm	XS-S-M-L

SIZE	ARTICLENUMBER	NOTES
SIZE XS	18SC3025	
SIZE S	18SC3026	
SIZE M	18SC3027	
SIZE L	18SC3028	



FLAT // urban gray / palladium silver / neon green

28 AL **SQUARE** CROSS 2.8



MODEL HIGHLIGHTS

- ▶ Shimano XT 9-speed rear derailleur
- ▶ Hydraulic disc brakes
- ▶ Color option available

MODELL HIGHLIGHTS

- ▶ Shimano XT 9-fach Schaltwerk
- ▶ Hydraulische Scheibenbremsen
- ▶ Mit Farboption

SQUARE Cross AL	Shimano Acera FD-M3000	Continental Speed RIDE 42-622 // Continental Speed RIDE 42-622	Justek 3050 HRN
SR Suntour SF16 NEX HLO-DS 50 mm	Shimano Altus SL-M2000	Rodi Excalibur XC 622x19 mm 32H // Rodi Excalibur XC 622x19 mm 32H	14106
GHOST SQUARE Dia. 31.8 mm	Shimano FC-T 4010 48-36-26	Formula DC 20 OR	BSA 68 mm
GHOST Low Rizer SQUARE 680 mm Rise 15 mm Dia. 31.8 mm	Shimano CS-HG-200-9 11-34	Formula DC 22 OR	EZ1954
Shimano XT RD-M772 9-S Shadow Profile	Tektro HD-M285 2/2 Piston 160 mm Disc	GHOST SP-DC1 31.6 mm	S-M-L-XL

SIZE	ARTICLENUMBER	NOTES
SIZE S	18SC1013	
SIZE M	18SC1014	
SIZE L	18SC1015	
SIZE XL	18SC1016	



MODEL HIGHLIGHTS

- ▶ Shimano XT 9-speed rear derailleur
- ▶ Hydraulic disc brakes
- ▶ Color option available

MODELL HIGHLIGHTS

- ▶ Shimano XT 9-fach Schaltwerk
- ▶ Hydraulische Scheibenbremsen
- ▶ Mit Farboption

SQUARE Cross AL	Shimano Acera FD-M3000	Continental Speed RIDE 42-622 // Continental Speed RIDE 42-622	Justek 3050 DRN
SR Suntour SF16 NEX HLO-DS 50 mm	Shimano Altus SL-M2000	Rodi Excalibur XC 622x19 mm 32H // Rodi Excalibur XC 622x19 mm 32H	14106
GHOST SQUARE Dia. 31.8 mm	Shimano FC-T 4010 48-36-26	Formula DC 20 OR	BSA 68 mm
GHOST Low Rizer SQUARE 680 mm Rise 15 mm Dia. 31.8 mm	Shimano CS-HG-200-9 11-34	Formula DC 22 OR	EZ1954
Shimano XT RD-M772 9-S Shadow Profile	Tektro HD-M285 2/2 Piston 160 mm Disc	GHOST SP-DC1 31.6 mm	XS-S-M-L

SIZE	ARTICLENUMBER	NOTES
SIZE XS	18SC3013	
SIZE S	18SC3014	
SIZE M	18SC3015	
SIZE L	18SC3016	



FLAT // night blue / navi blue / vibrant blue

28 AL **SQUARE** CROSS 2.8



MODEL HIGHLIGHTS

- ▶ Shimano XT 9-speed rear derailleur
- ▶ Hydraulic disc brakes
- ▶ Color option available

MODELL HIGHLIGHTS

- ▶ Shimano XT 9-fach Schaltwerk
- ▶ Hydraulische Scheibenbremsen
- ▶ Mit Farboption

SQUARE Cross AL	Shimano Acera FD-M3000	Continental Speed RIDE 42-622 // Continental Speed RIDE 42-622	Justek 3050 HRN
SR Suntour SF16 NEX HLO-DS 50 mm	Shimano Altus SL-M2000	Rodi Excalibur XC 622x19 mm 32H // Rodi Excalibur XC 622x19 mm 32H	14106
GHOST SQUARE Dia. 31.8 mm	Shimano FC-T 4010 48-36-26	Formula DC 20 OR	BSA 68 mm
GHOST Low Rizer SQUARE 680 mm Rise 15 mm Dia. 31.8 mm	Shimano CS-HG-200-9 11-34	Formula DC 22 OR	EZ1954
Shimano XT RD-M772 9-S Shadow Profile	Tektro HD-M285 2/2 Piston 160 mm Disc	GHOST SP-DC1 31.6 mm	S-M-L-XL

SIZE	ARTICLENUMBER	NOTES
SIZE S	18SC1019	
SIZE M	18SC1020	
SIZE L	18SC1021	
SIZE XL	18SC1022	



MODEL HIGHLIGHTS

- ▶ Shimano XT 9-speed rear derailleur
- ▶ Hydraulic disc brakes
- ▶ Color option available

MODELL HIGHLIGHTS

- ▶ Shimano XT 9-fach Schaltwerk
- ▶ Hydraulische Scheibenbremsen
- ▶ Mit Farboption

SQUARE Cross AL	Shimano Acera FD-M3000	Continental Speed RIDE 42-622 // Continental Speed RIDE 42-622	Justek 3050 DRN
SR Suntour SF16 NEX HLO-DS 50 mm	Shimano Altus SL-M2000	Rodi Excalibur XC 622x19 mm 32H // Rodi Excalibur XC 622x19 mm 32H	14106
GHOST SQUARE Dia. 31.8 mm	Shimano FC-T 4010 48-36-26	Formula DC 20 OR	BSA 68 mm
GHOST Low Rizer SQUARE 680 mm Rise 15 mm Dia. 31.8 mm	Shimano CS-HG-200-9 11-34	Formula DC 22 OR	EZ1954
Shimano XT RD-M772 9-S Shadow Profile	Tektro HD-M285 2/2 Piston 160 mm Disc	GHOST SP-DC1 31.6 mm	XS-S-M-L

SIZE	ARTICLENUMBER	NOTES
SIZE XS	18SC3019	
SIZE S	18SC3020	
SIZE M	18SC3021	
SIZE L	18SC3022	



FLAT // titanium gray / microchip gray / palladium silver

28 AL **SQUARE** CROSS 1.8



MODEL HIGHLIGHTS

- ▶ Continental Speed RIDE tires
- ▶ Hydraulic disc brakes
- ▶ Color option available

MODELL HIGHLIGHTS

- ▶ Continental Speed RIDE Bereifung
- ▶ Hydraulische Scheibenbremsen
- ▶ Mit Farboption

SQUARE Cross AL	Shimano Altus FD-M370	Continental Speed RIDE 42-622 // Continental Speed RIDE 42-622	Justek 3050 HRN
SR Suntour SF14 NEX DS-700C 50 mm	Shimano Altus SL-M2000	Rodi Excalibur XC 622x19 mm 32H // Rodi Excalibur XC 622x19 mm 32H	14106
GHOST SQUARE Dia. 31.8 mm	Shimano FC-M371 48-36-26	Formula DC 20 QR	BSA 68 mm
GHOST Low Rizer SQUARE 680 mm Rise 15 mm Dia. 31.8 mm	Shimano CS-HG-200-9 11-34	Formula DC 22 QR	EZ1954
Shimano Altus RD-M2000 9-S Shadow Design	Tektro HD-M285 2/2 Piston 160 mm Disc	GHOST SP-DC1 31.6 mm	S-M-L-XL

SIZE	ARTICLENUMBER	NOTES
SIZE S	18SC1007	
SIZE M	18SC1008	
SIZE L	18SC1009	
SIZE XL	18SC1010	



MODEL HIGHLIGHTS

- ▶ Continental Speed RIDE tires
- ▶ Hydraulic disc brakes
- ▶ Color option available

MODELL HIGHLIGHTS

- ▶ Continental Speed RIDE Bereifung
- ▶ Hydraulische Scheibenbremsen
- ▶ Mit Farboption

SQUARE Cross AL	Shimano Altus FD-M370	Continental Speed RIDE 42-622 // Continental Speed RIDE 42-622	Justek 3050 DRN
SR Suntour SF14 NEX DS-700C 50 mm	Shimano Altus SL-M2000	Rodi Excalibur XC 622x19 mm 32H // Rodi Excalibur XC 622x19 mm 32H	14106
GHOST SQUARE Dia. 31.8 mm	Shimano FC-M371 48-36-26	Formula DC 20 OR	BSA 68 mm
GHOST Low Rizer SQUARE 680 mm Rise 15 mm Dia. 31.8 mm	Shimano CS-HG-200-9 11-34	Formula DC 22 OR	EZ1954
Shimano Altus RD-M2000 9-S Shadow Design	Tektro HD-M285 2/2 Piston 160 mm Disc	GHOST SP-DC1 31.6 mm	XS-S-M-L

SIZE	ARTICLENUMBER	NOTES
SIZE XS	18SC3007	
SIZE S	18SC3008	
SIZE M	18SC3009	
SIZE L	18SC3010	



FLAT // palladium silver / iridium silver / neon yellow

28 AL **SQUARE** CROSS 1.8



MODEL HIGHLIGHTS

- ▶ Continental Speed RIDE tires
- ▶ Hydraulic disc brakes
- ▶ Color option available

MODELL HIGHLIGHTS

- ▶ Continental Speed RIDE Bereifung
- ▶ Hydraulische Scheibenbremsen
- ▶ Mit Farboption

SQUARE Cross AL	Shimano Altus FD-M370	Continental Speed RIDE 42-622 // Continental Speed RIDE 42-622	Justek 3050 HRN
SR Suntour SF14 NEX DS-700C 50 mm	Shimano Altus SL-M2000	Rodi Excalibur XC 622x19 mm 32H // Rodi Excalibur XC 622x19 mm 32H	14106
GHOST SQUARE Dia. 31.8 mm	Shimano FC-M371 48-36-26	Formula DC 20 OR	BSA 68 mm
GHOST Low Rizer SQUARE 680 mm Rise 15 mm Dia. 31.8 mm	Shimano CS-HG-200-9 11-34	Formula DC 22 OR	EZ1954
Shimano Altus RD-M2000 9-S Shadow Design	Tektro HD-M285 2/2 Piston 160 mm Disc	GHOST SP-DC1 31.6 mm	S-M-L-XL

SIZE	ARTICLENUMBER	NOTES
SIZE S	18SC1001	
SIZE M	18SC1002	
SIZE L	18SC1003	
SIZE XL	18SC1004	



MODEL HIGHLIGHTS

- ▶ Continental Speed RIDE tires
- ▶ Hydraulic disc brakes
- ▶ Color option available

MODELL HIGHLIGHTS

- ▶ Continental Speed RIDE Bereifung
- ▶ Hydraulische Scheibenbremsen
- ▶ Mit Farboption

SQUARE Cross AL	Shimano Altus FD-M370	Continental Speed RIDE 42-622 // Continental Speed RIDE 42-622	Justek 3050 DRN
SR Suntour SF14 NEX DS-700C 50 mm	Shimano Altus SL-M2000	Rodi Excalibur XC 622x19 mm 32H // Rodi Excalibur XC 622x19 mm 32H	14106
GHOST SQUARE Dia. 31.8 mm	Shimano FC-M371 48-36-26	Formula DC 20 OR	BSA 68 mm
GHOST Low Rizer SQUARE 680 mm Rise 15 mm Dia. 31.8 mm	Shimano CS-HG-200-9 11-34	Formula DC 22 OR	EZ1954
Shimano Altus RD-M2000 9-S Shadow Design	Tektro HD-M285 2/2 Piston 160 mm Disc	GHOST SP-DC1 31.6 mm	XS-S-M-L

SIZE	ARTICLENUMBER	NOTES
SIZE XS	18SC3001	
SIZE S	18SC3002	
SIZE M	18SC3003	
SIZE L	18SC3004	

SQUARE TREKKING



// TREKKING / LEISURE

FEATURES



CHARACTERISTICS

- ▶ All models fully equipped including hub dynamo
- ▶ High-quality trekking bike with comfortable contact points
- ▶ New: completely reworked carrier

CHARAKTERISTIK

- ▶ Alle Modelle mit Vollausstattung und Nabendynamo
- ▶ Hochwertiges Trekkingrad mit komfortablen Kontaktpunkten
- ▶ Neu: komplett überarbeiteter Gepäckträger

TARGET GROUP

- ▶ Comfort-oriented trekking riders with a sense of appreciation for design

ZIELGRUPPE

- ▶ Komfortorientierte Trekkingfahrer mit Sinn für Design



// GEOMETRY AND DATA CHARTS / GEOMETRIE UND TECHNISCHE DATEN

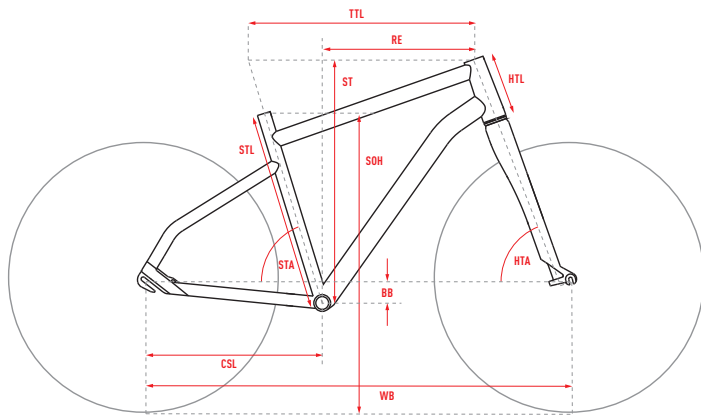

ALL DIMENSIONS IN MM (EXCEPT HTA AND STA IN °)

ALLE MASSE IN MM (AUSNAHME HTA UND STA IN °)

- STL** SEAT TUBE LENGTH
SITZROHRLÄNGE
- CSL** CHAINSTAY LENGTH
KETTENSTREBENLÄNGE
- TTL** TOP TUBE LENGTH
OBERROHRLÄNGE
- HTL** HEADTUBE LENGTH
STEUERROHRLÄNGE
- HTA** HEADTUBE ANGLE
STEUERROHRWINKEL
- STA** SEATTUBE ANGLE
SITZROHRWINKEL
- BB** BB DROP
TRETLAGERABSENKUNG
- WB** WHEELBASE
RADSTAND
- ST** STACK
STACK
- RE** REACH
REACH
- SOH** STANDOVER HEIGHT
ÜBERSTANDSHÖHE
- Head Set Diameter (Upper / Lower)**
STEUERSATZDURCHMESSER (OBEN / UNTEN)
- Axle Standard (Rear / Front)**
ACHSENSTANDARD (HINTEN / VORNE)
- Bottom Bracket Standard**
TRETLAGERSTANDARD
- Seat Post Diameter**
SITZELSTÜTZENDURCHMESSER
- Shock Hardware (Ø 8MM)**
DÄMPFERBUCHSENMASSE (Ø 8MM)
- Shock Length**
DÄMPFEREINBAULÄNGE
- Shock Travel**
DÄMPFERHUB
- Front Fork Travel**
FEDERWEG VORNE
- Rear Wheel Travel**
FEDERWEG HINTEN
- Min Saddle Height**
MIN SÄTTELHÖHE
- Max Saddle Height**
MAX SÄTTELHÖHE
- Min Inseam**
MIN SCHRITTLÄNGE
- Max Inseam**
MAX SCHRITTLÄNGE
- Stem Length**
VORBAULÄNGE
- Handlebar Width**
LENKERBREITE
- Crank Length**
KURBELLÄNGE
- Seat Tube Mount**
FLASCHE SÄTTELROHR
- Down Tube Mount**
FLASCHE UNTERROHR

	STL	CSL	TTL	HTL	HTA	STA	BB	WB	ST	RE	SOH	Head Set Diameter (Upper / Lower)	Axle Standard (Rear / Front)	Bottom Bracket Standard	Seat Post Diameter	Shock Hardware (Ø 8MM)	Shock Length	Shock Travel	Front Fork Travel	Rear Wheel Travel	Min Saddle Height	Max Saddle Height	Min Inseam	Max Inseam	Stem Length	Handlebar Width	Crank Length	Seat Tube Mount	Down Tube Mount		
SQUARE TREKKING 8.8 AL U																															
S	470	455	580	160	70	73.5	60	1105	636	391	735	ZS44/ZS56	135/100	BSA 68	31.6	/	/	/	65	/	80	680	170	0.75	0.75						
M	520	455	595	165	70	72.5	60	1108	641	393	770	ZS44/ZS56	135/100	BSA 68	31.6	/	/	/	65	/	80	680	170	0.75	0.75						
L	570	455	610	185	71	72.5	60	1112	664	400	815	ZS44/ZS56	135/100	BSA 68	31.6	/	/	/	65	/	80	680	170	0.75	0.75						
XL	620	455	625	205	71	72	60	1121	683	403	855	ZS44/ZS56	135/100	BSA 68	31.6	/	/	/	65	/	80	680	170	0.75	0.75						
SQUARE TREKKING 8.8 AL W																															
XS	420	455	560	150	70.5	73	60	1073	629	368	630	ZS44/ZS56	135/100	BSA 68	31.6	/	/	/	65	/	80	680	170	/	0.75						
S	470	455	575	155	70.5	72	60	1076	634	369	625	ZS44/ZS56	135/100	BSA 68	31.6	/	/	/	65	/	80	680	170	/	0.75						
M	520	455	590	170	70.5	72	60	1091	648	379	625	ZS44/ZS56	135/100	BSA 68	31.6	/	/	/	65	/	80	680	170	/	0.75						
L	560	455	610	185	70.5	72	60	1112	662	395	625	ZS44/ZS56	135/100	BSA 68	31.6	/	/	/	65	/	80	680	170	/	0.75						
SQUARE TREKKING 6.8 AL U																															
S	470	455	580	160	70	73.5	60	1105	636	391	735	ZS44/ZS56	135/100	BSA 68	31.6	/	/	/	/	/	80	680	170	0.75	0.75						
M	520	455	595	165	70	72.5	60	1108	641	393	770	ZS44/ZS56	135/100	BSA 68	31.6	/	/	/	/	/	80	680	170	0.75	0.75						
L	570	455	610	185	71	72.5	60	1112	664	400	815	ZS44/ZS56	135/100	BSA 68	31.6	/	/	/	/	/	80	680	170	0.75	0.75						
XL	620	455	625	205	71	72	60	1121	683	403	855	ZS44/ZS56	135/100	BSA 68	31.6	/	/	/	/	/	80	680	170	0.75	0.75						
SQUARE TREKKING 6.8 AL W																															
XS	420	455	560	150	70.5	73	60	1073	629	368	630	ZS44/ZS56	135/100	BSA 68	31.6	/	/	/	/	/	80	680	170	/	0.75						
S	470	455	575	155	70.5	72	60	1076	634	369	625	ZS44/ZS56	135/100	BSA 68	31.6	/	/	/	/	/	80	680	170	/	0.75						
M	520	455	590	170	70.5	72	60	1091	648	379	625	ZS44/ZS56	135/100	BSA 68	31.6	/	/	/	/	/	80	680	170	/	0.75						
L	560	455	610	185	70.5	72	60	1112	662	395	625	ZS44/ZS56	135/100	BSA 68	31.6	/	/	/	/	/	80	680	170	/	0.75						
SQUARE TREKKING 5.8 / 4.8 / 2.8 AL U																															
S	470	455	580	160	70	73.5	60	1105	636	391	735	ZS44/ZS56	135/100	BSA 68	31.6	/	/	/	50	/	80	680	170	0.75	0.75						
M	520	455	595	165	70	72.5	60	1108	641	393	770	ZS44/ZS56	135/100	BSA 68	31.6	/	/	/	50	/	80	680	170	0.75	0.75						
L	570	455	610	185	71	72.5	60	1112	664	400	815	ZS44/ZS56	135/100	BSA 68	31.6	/	/	/	50	/	80	680	170	0.75	0.75						
XL	620	455	625	205	71	72	60	1121	683	403	855	ZS44/ZS56	135/100	BSA 68	31.6	/	/	/	50	/	80	680	170	0.75	0.75						
SQUARE TREKKING 5.8 / 4.8 / 2.8 AL W																															
XS	420	455	560	150	70.5	73	60	1073	629	368	630	ZS44/ZS56	135/100	BSA 68	31.6	/	/	/	50	/	80	680	170	/	0.75						
S	470	455	575	155	70.5	72	60	1076	634	369	625	ZS44/ZS56	135/100	BSA 68	31.6	/	/	/	50	/	80	680	170	/	0.75						
M	520	455	590	170	70.5	72	60	1091	648	379	625	ZS44/ZS56	135/100	BSA 68	31.6	/	/	/	50	/	80	680	170	/	0.75						
L	560	455	610	185	70.5	72	60	1112	662	395	625	ZS44/ZS56	135/100	BSA 68	31.6	/	/	/	50	/	80	680	170	/	0.75						
SQUARE TREKKING 2 AL U																															
S	470	455	580	160	70	73.5	60	1105	636	391	735	ZS44/ZS56	135/100	BSA 68	31.6	/	/	/	50	/	90	660	175	0.75	0.75						
M	520	455	595	165	70	72.5	60	1108	641	393	770	ZS44/ZS56	135/100	BSA 68	31.6	/	/	/	50	/	90	660	175	0.75	0.75						
L	570	455	610	185	71	72.5	60	1112	664	400	815	ZS44/ZS56	135/100	BSA 68	31.6	/	/	/	50	/	90	660	175	0.75	0.75						
XL	620	455	625	205	71	72	60	1121	683	403	855	ZS44/ZS56	135/100	BSA 68	31.6	/	/	/	50	/	90	660	175	0.75	0.75						
SQUARE TREKKING 2 AL W																															
XS	420	455	560	150	70.5	73	60	1073	629	368	630	ZS44/ZS56	135/100	BSA 68	31.6	/	/	/	50	/	90	660	175	/	0.75						
S	470	455	575	155	70.5	72	60	1076	634	369	625	ZS44/ZS56	135/100	BSA 68	31.6	/	/	/	50	/	90	660	175	/	0.75						
M	520	455	590	170	70.5	72	60	1091	648	379	625	ZS44/ZS56	135/100	BSA 68	31.6	/	/	/	50	/	90	660	175	/	0.75						
L	560	455	610	185	70.5	72	60	1112	662	395	625	ZS44/ZS56	135/100	BSA 68	31.6	/	/	/	50	/	90	660	175	/	0.75						



FLAT // microchip gray / titanium gray / riot red



MODEL HIGHLIGHTS

- ▶ High quality Rock Shox Paragon fork
- ▶ Shimano XT brakes
- ▶ Schwalbe Marathon Supreme tires

MODELL HIGHLIGHTS

- ▶ Hochwertige Rock Shox Paragon Federgabel
- ▶ Shimano XT Bremsen
- ▶ Schwalbe Marathon Supreme Reifen

SQUARE Trekking AL	Shimano XT FC-T781 48-36-26	Satori HL Comet 31,6 mm	16358
Rock Shox Paragon Gold RL Solo Air 65 mm	Shimano CS-HG500-10 11-34	Justek 3050 HRN	BSA 68 mm
Satori HL STEALTH 6 Dia. 31.8 mm	Shimano XT BR-M8000 - BL-T8000 2/2 Piston 180/160 mm Disc	GHOST SQUARE Trekking Carrier	EZ1954
Satori Deviant Bow 680 mm Rise 12 mm Dia. 31.8 mm	Schwalbe Marathon Supreme 42-62Z // Schwalbe Marathon Supreme 42-62Z	GHOST RG40	S-M-L-XL
Shimano XT RD-T8000 Shadow Design 11-S	Rodi Excalibur XC 622x19 mm 32H // Rodi Excalibur XC 622x19 mm 32H	Pletscher	
Shimano Deore FD-T6000	KT Dynamo Hub JH-KC6F	Supernova E3 Pure3	
Shimano Deore SL-T6000	Shimano FH-RM33 QR	Supernova Tail Light	

SIZE	ARTICLENUMBER	NOTES
SIZE S	18ST2007	
SIZE M	18ST2008	
SIZE L	18ST2009	
SIZE XL	18ST2010	



MODEL HIGHLIGHTS

- ▶ High quality Rock Shox Paragon fork
- ▶ Shimano XT brakes
- ▶ Schwalbe Marathon Supreme tires

MODELL HIGHLIGHTS

- ▶ Hochwertige Rock Shox Paragon Federgabel
- ▶ Shimano XT Bremsen
- ▶ Schwalbe Marathon Supreme Reifen

SQUARE Trekking AL	Shimano XT FC-1781 48-36-26	Satori HL Comet 31.6 mm	16358
Rock Shox Paragon Gold RL Solo Air 65 mm	Shimano CS-HG500-10 11-34	Justek 3050 DRN	BSA 68 mm
Satori HL STEALTH 6 Dia. 31.8 mm	Shimano XT BR-M8000 - BL-T8000 2/2 Piston 180/160 mm Disc	GHOST SQUARE Trekking Carrier	E21954
Satori Deviant Bow 680 mm Rise 12 mm Dia. 31.8 mm	Schwalbe Marathon Supreme Race Guard 42-622 // Schwalbe Marathon Supreme Race Guard 42-622	GHOST RG40	XS-S-M-L
Shimano XT RD-T8000 Shadow Design 11-S	Rodi Excalibur XC 622x19 mm 32H // Rodi Excalibur XC 622x19 mm 32H	Pletscher	
Shimano Deore FD-T6000	KT Dynamo Hub JH-KC6F	Supernova E3 Pure3	
Shimano Deore SL-T6000	Shimano FH-RM33 QR	Supernova Tail Light	

SIZE	ARTICLENUMBER	NOTES
SIZE XS	18ST4007	
SIZE S	18ST4008	
SIZE M	18ST4009	
SIZE L	18ST4010	



FLAT // night blue / mountain blue / microchip gray



MODEL HIGHLIGHTS

- ▶ SRAM NX 1x11 drivetrain: no more front derailleur
- ▶ Reliable touring bike
- ▶ Maximum reliability and very lightweight rigid fork

MODELL HIGHLIGHTS

- ▶ SRAM NX 1x11-Antrieb: kein Umwerfer mehr
- ▶ Zuverlässiger Tourer
- ▶ Maximale Zuverlässigkeit und mit sehr leichter Starrgabel

SQUARE Trekking AL	SRAM NX X-Sync 38T	Satori HL Comet 31,6 mm	16358
GHOST AL Rigid	SRAM PG-1130 11-42	Justek 3050 HRN	BSA 68 mm
Satori HL STEALTH 6 Dia. 31.8 mm	Tektro HD-1285 2/2 Piston 180/160 mm Disc	GHOST SQUARE Trekking Carrier	EZ1954
Satori Deviant Bow 680 mm Rise 12 mm Dia. 31.8 mm	Michelin Protek 40-622 // Michelin Protek 40-622	GHOST RG40	S-M-L-XL
SRAM NX 11-S	Rodi Excalibur XC 622x19 mm 32H // Rodi Excalibur XC 622x19 mm 32H	Pletscher	
SRAM NX	Shimano Hub Dynamo DH-3D32-QR	Spanninga AXENDO 40 XDAS	
	Formula DC 22 QR	Herrmans H-Trace	

SIZE	ARTICLENUMBER	NOTES
SIZE S	18ST2001	
SIZE M	18ST2002	
SIZE L	18ST2003	
SIZE XL	18ST2004	



MODEL HIGHLIGHTS

- ▶ SRAM NX 1x11 drivetrain: no more front derailleur
- ▶ Reliable touring bike
- ▶ Maximum reliability and very lightweight rigid fork

MODELL HIGHLIGHTS

- ▶ SRAM NX 1x11-Antrieb: kein Umwerfer mehr
- ▶ Zuverlässiger Tourer
- ▶ Maximale Zuverlässigkeit und mit sehr leichter Starrgabel

SQUARE Trekking AL	SRAM NX X-Sync 38T	Satori HL Comet 31.6 mm	16358
GHOST AL Rigid	SRAM PG-1130 11-42	Justek 3050 DRN	BSA 68 mm
Satori HL STEALTH 6 Dia. 31.8 mm	Tektro HD-T285 2/2 Piston 180/160 mm Disc	GHOST SQUARE Trekking Carrier	E21954
Satori Deviant Bow 680 mm Rise 12 mm Dia. 31.8 mm	Michelin Protek 40-622 // Michelin Protek 40-622	GHOST RG40	XS-S-M-L
SRAM NX 11-S	Rodi Excalibur XC 622x19 mm 32H // Rodi Excalibur XC 622x19 mm 32H	Pletscher	
-	Shimano Hub Dynamo DH-3032-DR	Spanninga AXENDO 40 XDAS	
SRAM NX	Formula DC 22 QR	Herrmans H-Trace	

SIZE	ARTICLENUMBER	NOTES
SIZE XS	18ST4001	
SIZE S	18ST4002	
SIZE M	18ST4003	
SIZE L	18ST4004	



FLAT // night black / titanium gray / juice orange

28 AL **SQUARE** TREKKING 5.8



MODEL HIGHLIGHTS

- ▶ Shimano XT 10-speed rear derailleur
- ▶ Busch & Müller Lumotec headlight

MODELL HIGHLIGHTS

- ▶ Shimano XT 10-fach Schaltwerk
- ▶ Busch & Müller Lumotec Frontlicht

SQUARE Trekking AL	Shimano FC-T521 48-36-26	Satori HL Comet 31,6 mm	14106
RST Nova MLO 50 mm	Shimano CS-HG500-10 11-34	Justek 3050 HRN	BSA 68 mm
Satori HL STEALTH 6 Dia. 31.8 mm	Tektro HD-1285 2/2 Piston 180/160 mm Disc	GHOST SQUARE Trekking Carrier	EZ1954
Satori Deviant Bow 680 mm Rise 12 mm Dia. 31.8 mm	Michelin Protek 40-622 // Michelin Protek 40-622	GHOST RG40	S-M-L-XL
Shimano XT RD-M781 10-S Shadow Design	Rodi Excalibur XC 622x19 mm 32H // Rodi Excalibur XC 622x19 mm 32H	Pletscher ZOOM	
Shimano Deore FD-T6000	Shimano Hub Dynamo DH-3D32-QR	Busch & Müller LUMOTEC UPP N Plus	
Shimano Deore SL-T6000	Formula DC 22 QR	Herrmans H-Trace	

SIZE	ARTICLENUMBER	NOTES
SIZE S	18ST1019	
SIZE M	18ST1020	
SIZE L	18ST1021	
SIZE XL	18ST1022	



MODEL HIGHLIGHTS

- ▶ Shimano XT 10-speed rear derailleur
- ▶ Busch & Müller Lumotec headlight

MODELL HIGHLIGHTS

- ▶ Shimano XT 10-fach Schaltwerk
- ▶ Busch & Müller Lumotec Frontlicht

SQUARE Trekking AL	Shimano FC-1521 48-36-26	Satori HL Comet 31.6 mm	14106
RST Nova MLO 50 mm	Shimano CS-HG500-10 11-34	Justek 3050 DRN	BSA 68 mm
Satori HL STEALTH 6 Dia. 31.8 mm	Tektro HD-T285 2/2 Piston 180/160 mm Disc	GHOST SQUARE Trekking Carrier	E21954
Satori Deviant Bow 680 mm Rise 12 mm Dia. 31.8 mm	Michelin Protek 40-622 // Michelin Protek 40-622	GHOST RG40	XS-S-M-L
Shimano XT RD-M781 10-S Shadow Design	Rodi Excalibur XC 622x19 mm 32H // Rodi Excalibur XC 622x19 mm 32H	Pletscher ZOOM	
Shimano Deore FD-T6000	Shimano Hub Dynamo DH-3032-DR	Busch & Müller LUMOTEC UPP N Plus	
Shimano Deore SL-T6000	Formula DC 22 QR	Herrmans H-Trace	
SIZE	ARTICLENUMBER	NOTES	
SIZE XS	18ST3019		
SIZE S	18ST3020		
SIZE M	18ST3021		
SIZE L	18ST3022		



FLAT // night black / titanium gray / lime green

28 AL **SQUARE** TREKKING 4.8



MODEL HIGHLIGHTS

- ▶ Equipped with Shimano hub dynamo
- ▶ Shimano Deore 9-speed rear derailleur
- ▶ Integrated lighting system

MODELL HIGHLIGHTS

- ▶ Mit Shimano Nabendynamo
- ▶ Shimano Deore 9-fach Schaltwerk
- ▶ Integrierte Beleuchtung

SQUARE Trekking AL	Shimano FC-M371 48-36-26	Satori HL Comet 31,6 mm	14106
SR Suntour SF16 NEX HLO DS 50 mm	Shimano CS-HG-200-9 11-32	Justek 3050 HRN	BSA 68 mm
Satori HL STEALTH 6 Dia. 31.8 mm	Tektro HD-1285 2/2 Piston 160 mm Disc	GHOST SQUARE Trekking Carrier	EZ1954
GHOST Low Rizer SQUARE 680 mm Rise 15 mm Dia. 31.8 mm	Michelin Protek 40-622 // Michelin Protek 40-622	GHOST RG40	S-M-L-XL
Shimano Deore RD-M592 9-S Shadow Design	Rodi Excalibur XC 622x19 mm 32H // Rodi Excalibur XC 622x19 mm 32H	Pletscher ZOOM	
Shimano Acera FD-M3000	Shimano Hub Dynamo DH-3D32-QR	Axa BlueLine 30	
Shimano Acera SL-M3000	Formula DC 22 QR	Herrmans H-Trace	

SIZE	ARTICLENUMBER	NOTES
SIZE S	18ST1013	
SIZE M	18ST1014	
SIZE L	18ST1015	
SIZE XL	18ST1016	



MODEL HIGHLIGHTS

- ▶ Equipped with Shimano hub dynamo
- ▶ Shimano Deore 9-speed rear derailleur
- ▶ Integrated lighting system

MODELL HIGHLIGHTS

- ▶ Mit Shimano Nabendynamo
- ▶ Shimano Deore 9-fach Schaltwerk
- ▶ Integrierte Beleuchtung

SQUARE Trekking AL	Shimano FC-M371 48-36-26	Satori HL Comet 31.6 mm	14106
SR Suntour SF16 NEX HLO DS 50 mm	Shimano CS-HG-200-9 11-32	Justek 3050 DRN	BSA 68 mm
Satori HL STEALTH 6 Dia. 31.8 mm	Tektro HD-T285 2/2 Piston 160 mm Disc	GHOST SQUARE Trekking Carrier	E21954
GHOST Low Rizer SQUARE 680 mm Rise 15 mm Dia. 31.8 mm	Michelin Protek 40-622 // Michelin Protek 40-622	GHOST RG40	XS-S-M-L
Shimano Deore RD-M592 9-S Shadow Design	Rodi Excalibur XC 622x19 mm 32H // Rodi Excalibur XC 622x19 mm 32H	Pletscher ZOOM	
Shimano Acera FD-M3000	Shimano Hub Dynamo DH-3032-DR	Axa Blueline 30	
Shimano Acera SL-M3000	Formula DC 22 QR	Herrmans H-Trace	

SIZE	ARTICLENUMBER	NOTES
SIZE XS	18ST3013	
SIZE S	18ST3014	
SIZE M	18ST3015	
SIZE L	18ST3016	



FLAT // metallic blue / silver gray



MODEL HIGHLIGHTS

- ▶ Design option for the entry level models
- ▶ Reliable components

MODELL HIGHLIGHTS

- ▶ Designoption im Einstiegsbereich
- ▶ Zuverlässige Ausstattung

SQUARE Trekking AL	Shimano SL-M310	Shimano Hub Dynamo DH-3032-OR	Pletscher
RST Nova MLO 50 mm	Shimano FC-M171 48-38-28	Formula DC-22 QR	Axa Blueline 30
Satori UP2 Plus 31.8 mm	Shimano CS-HG-200-8 12-32	Satori Coment 31.6 mm	Herrmans H-Trace
Satori Noir 660 mm Rise 23 mm Dia. 31.8 mm	Tektro HD-M285 2/2 Piston 160 mm Disc	Justek 3050 HRN	BSA 68 mm
Shimano Altus RD-M310 8-S	Impac Streetpac 42-622 // Impac Streetpac 42-622	GHOST SQUARE Trekking Carrier	S-M-L-XL
Shimano Tourney FD-TY710	Rodi Excalibur XC 622x19 mm 32H // Rodi Excalibur XC 622x19 mm 32H	Wingee W40	

SIZE	ARTICLENUMBER	NOTES
SIZE S	18ST2037	
SIZE M	18ST2038	
SIZE L	18ST2039	
SIZE XL	18ST2040	



MODEL HIGHLIGHTS

- ▶ Design option for the entry level models
- ▶ Reliable components

MODELL HIGHLIGHTS

- ▶ Designoption im Einstiegsbereich
- ▶ Zuverlässige Ausstattung

SQUARE Trekking AL	Shimano SL-M310	Shimano Hub Dynamo DH-3D32-QR	Pletscher
RST Nova MLO 50 mm	Shimano FC-M171 48-38-28	Formula DC-22 QR	Axa BlueLine 30
Satori UP2 Plus 31.8 mm	Shimano CS-HG-200-8 12-32	Satori Coment 31.6 mm	Herrmans H-Trace
Satori Noirette Plus WS 660 mm Dia. 31.8 mm	Tektro HD-M285 2/2 Piston 160 mm Disc	Justek 3050 DRN	BSA 68 mm
Shimano Altus RD-M310 8-S	Impac Streetpac 42-622 // Impac Streetpac 42-622	GHOST SQUARE Trekking Carrier	XS-S-M-L
Shimano Tourney FD-TY710	Rodi Excalibur XC 622x19 mm 32H // Rodi Excalibur XC 622x19 mm 32H	Wingee W40	

SIZE	ARTICLENUMBER	NOTES
SIZE XS	18ST4013	
SIZE S	18ST4014	
SIZE M	18ST4015	
SIZE L	18ST4016	



FLAT // night black / titanium gray / riot red



MODEL HIGHLIGHTS

- ▶ High-quality SQUARE frame
- ▶ Entry-level trekking bike
- ▶ Color option available

MODELL HIGHLIGHTS

- ▶ Hochwertiger SQUARE Rahmen
- ▶ Einstieg in den Trekkingbereich
- ▶ Mit Farboption

SQUARE Trekking AL	Shimano Tourney FC-TX801 48-38-28	GHOST SP-DC1 31.6 mm	14106
SR Suntour SF14 NEX DS 50 mm	Shimano CS-HG31 11-34	Justek 3050 HRN	BSA 68 mm
GHOST SQUARE Dia. 31.8 mm	Tektro HD-1285 2/2 Piston 160 mm Disc	GHOST SQUARE Trekking Carrier	EZ1954
GHOST Low Rizer SQUARE 680 mm Rise 15 mm Dia. 31.8 mm	Michelin Protek 40-622 // Michelin Protek 40-622	GHOST RG40	S-M-L-XL
Shimano Altus RD-M310 8-S	Rodi Excalibur XC 622x19 mm 32H // Rodi Excalibur XC 622x19 mm 32H	Pletscher ZOOM	
Shimano FD-M310	Shimano Hub Dynamo DH-3D32-QR	Spanninga Brio XDO	
Shimano SL-M310	Formula DC 22 QR	Spanninga Vivo XDS	

SIZE	ARTICLENUMBER	NOTES
SIZE S	18ST1007	
SIZE M	18ST1008	
SIZE L	18ST1009	
SIZE XL	18ST1010	



MODEL HIGHLIGHTS

- ▶ High-quality SQUARE frame
- ▶ Integrated lighting system
- ▶ Color option available

MODELL HIGHLIGHTS

- ▶ Hochwertiger SQUARE Rahmen
- ▶ Integrierte Beleuchtung
- ▶ Mit Farboption

SQUARE Trekking AL	Shimano Tourney FC-TX801 48-38-28	GHOST SP-DC1 31.6 mm	14106
SR Suntour SF14 NEX DS 50 mm	Shimano CS-HG31 11-34	Justek 3050 DRN	BSA 68 mm
GHOST SQUARE Dia. 31.8 mm	Tektro HD-T285 2/2 Piston 160 mm Disc	GHOST SQUARE Trekking Carrier	E21954
GHOST Low Rizer SQUARE 680 mm Rise 15 mm Dia. 31.8 mm	Michelin Protek 40-622 // Michelin Protek 40-622	GHOST RG40	XS-S-M-L
Shimano Altus RD-M310 8-S	Rodi Excalibur XC 622x19 mm 32H // Rodi Excalibur XC 622x19 mm 32H	Pletscher ZOOM	
Shimano FD-M310	Shimano Hub Dynamo DH-3032-DR	Spanninga Brio XDD	
Shimano SL-M310	Formula DC 22 QR	Spanninga Vivo XDS	

SIZE	ARTICLENUMBER	NOTES
SIZE XS	18ST3007	
SIZE S	18ST3008	
SIZE M	18ST3009	
SIZE L	18ST3010	



FLAT // iridium silver / microchip gray / lime green



MODEL HIGHLIGHTS

- ▶ High-quality SQUARE frame
- ▶ Entry-level trekking bike
- ▶ Color option available

MODELL HIGHLIGHTS

- ▶ Hochwertiger SQUARE Rahmen
- ▶ Einstieg in den Trekkingbereich
- ▶ Mit Farboption

SQUARE Trekking AL	Shimano Tourney FC-TX801 48-38-28	GHOST SP-DC1 31.6 mm	14106
SR Suntour SF14 NEX DS 50 mm	Shimano CS-HG31 11-34	Justek 3050 HRN	BSA 68 mm
GHOST SQUARE Dia. 31.8 mm	Tektro HD-1285 2/2 Piston 160 mm Disc	GHOST SQUARE Trekking Carrier	EZ1954
GHOST Low Rizer SQUARE 680 mm Rise 15 mm Dia. 31.8 mm	Michelin Protek 40-622 // Michelin Protek 40-622	GHOST RG40	S-M-L-XL
Shimano Altus RD-M310 8-S	Rodi Excalibur XC 622x19 mm 32H // Rodi Excalibur XC 622x19 mm 32H	Pletscher ZOOM	
Shimano FD-M310	Shimano Hub Dynamo DH-3D32-QR	Spanninga Brio XDO	
Shimano SL-M310	Formula DC 22 QR	Spanninga Vivo XDS	

SIZE	ARTICLENUMBER	NOTES
SIZE S	18ST1001	
SIZE M	18ST1002	
SIZE L	18ST1003	
SIZE XL	18ST1004	



MODEL HIGHLIGHTS

- ▶ High-quality SQUARE frame
- ▶ Integrated lighting system
- ▶ Color option available

MODELL HIGHLIGHTS

- ▶ Hochwertiger SQUARE Rahmen
- ▶ Integrierte Beleuchtung
- ▶ Mit Farboption

SQUARE Trekking AL	Shimano Tourney FC-TX801 48-38-28	GHOST SP-DC1 31.6 mm	14106
SR Suntour SF14 NEX DS 50 mm	Shimano CS-HG31 11-34	Justek 3050 DRN	BSA 68 mm
GHOST SQUARE Dia. 31.8 mm	Tektro HD-T285 2/2 Piston 160 mm Disc	GHOST SQUARE Trekking Carrier	E21954
GHOST Low Rizer SQUARE 680 mm Rise 15 mm Dia. 31.8 mm	Michelin Protek 40-622 // Michelin Protek 40-622	GHOST RG40	XS-S-M-L
Shimano Altus RD-M310 8-S	Rodi Excalibur XC 622x19 mm 32H // Rodi Excalibur XC 622x19 mm 32H	Pletscher ZOOM	
Shimano FD-M310	Shimano Hub Dynamo DH-3032-DR	Spanninga Brio XDD	
Shimano SL-M310	Formula DC 22 QR	Spanninga Vivo XDS	

SIZE	ARTICLENUMBER	NOTES
SIZE XS	18ST3001	
SIZE S	18ST3002	
SIZE M	18ST3003	
SIZE L	18ST3004	

LECTOR^{KID}



26" WHEELSET FOR OUTSTANDING AGILITY // 26"-LAUFRÄDER FÜR HERVORRAGENDE WENDIGKEIT

PROFESSIONAL FRAME FOR AMBITIOUS CLIMBERS // PROFI-RAHMEN FÜR AMBITIONIERTE AUFSTEIGER

FRAME CAN ALSO ACCOMMODATE 27.5" WHEELS // RAHMEN LÄSST SICH AUCH MIT 27,5"-LAUFRÄDERN AUFBAUEN

LIGHTWEIGHT AIR FORK WITH CHILD-APPROPRIATE SUSPENSION TUNING // LEICHTE LUFTGABEL MIT KINDGERECHTEM DÄMPFUNGS-TUNE

SMALL 28T CHAINRING WITH SRAM 1X11 REAR DERAILLEUR // KLEINES 28ER-KETTENBLATT MIT SRAM 1X11-SCHALTUNG

// KIDS / RACE

FEATURES



CHARACTERISTICS

- ▶ Compact frame for optimum agility and playful riding characteristics
- ▶ Child-appropriate package with ergonomically optimized equipment
- ▶ Intuitive handling, easy to use components, full focus on riding
- ▶ Lightweight and stiff for optimum pedaling efficiency of the young and wild

CHARAKTERISTIK

- ▶ Kompakter Rahmen für beste Wendigkeit und spielerisches Fahrverhalten
- ▶ Kindgerechtes Gesamtpaket mit ergonomisch optimierter Ausstattung
- ▶ Intuitives Handling mit unkomplizierten Bedienelementen für vollen Fokus auf die Strecke
- ▶ Leicht und steif für bestmögliche Treteffizienz der jungen Wilden

TARGET GROUP

- ▶ For young upcoming talents and the future heroes of racing

ZIELGRUPPE

- ▶ Für heranwachsende Talente und die zukünftigen Helden des Rennsports



LECTOR KID

// GEOMETRY AND DATA CHARTS / GEOMETRIE UND TECHNISCHE DATEN

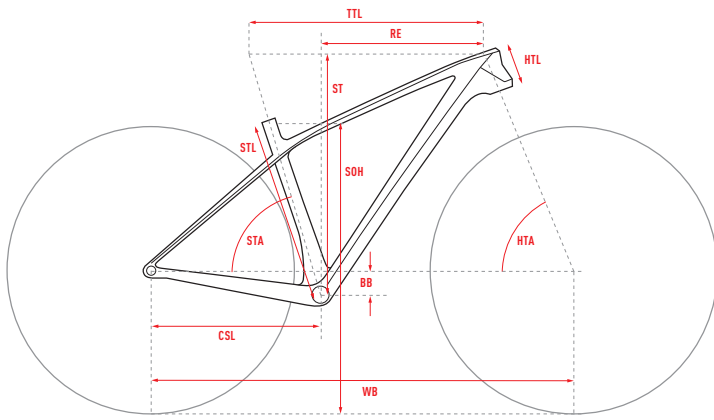

ALL DIMENSIONS IN MM (EXCEPT HTA AND STA IN °)

ALLE MASSE IN MM (AUSNAHME HTA UND STA IN °)

STL	SEAT TUBE LENGTH SITZROHRLÄNGE		SHOCK HARDWARE (Ø 8MM) DÄMPFERBUCHSENMASSE (Ø 8MM)
CSL	CHAINSTAY LENGTH KETTENSTREBENLÄNGE		SHOCK LENGTH DÄMPFEREINBAULÄNGE
TTL	TOP TUBE LENGTH OBERROHRLÄNGE		SHOCK TRAVEL DÄMPFERHUB
HTL	HEADTUBE LENGTH STEUERROHRLÄNGE		FRONT FORK TRAVEL FEDERWEG VORNE
HTA	HEADTUBE ANGLE STEUERROHRWINKEL		REAR WHEEL TRAVEL FEDERWEG HINTEN
STA	SEATTUBE ANGLE SITZROHRWINKEL		MIN SADDLE HEIGHT MIN SÄTTELHÖHE
BB	BB DROP TRETLAGERABSSENKUNG		MAX SADDLE HEIGHT MAX SÄTTELHÖHE
WB	WHEELBASE RADSTAND		MIN INSEAM MIN SCHRITTLÄNGE
ST	STACK STACK		MAX INSEAM MAX SCHRITTLÄNGE
RE	REACH REACH		STEM LENGTH VORBAULÄNGE
SOH	STANDOVER HEIGHT ÜBERSTANDSHÖHE		HANDLEBAR WIDTH LENKERBREITE
	HEAD SET DIAMETER (UPPER / LOWER) STEUERSATZDURCHMESSER (OBEN / UNTEN)		CRANK LENGTH KURBELLÄNGE
	AXLE STANDARD (REAR / FRONT) ACHSENSTANDARD (HINTEN / VORNE)		SEATTUBE BOTTLE MOUNT FLASCHE SÄTTELROHR
	BOTTOM BRACKET STANDARD TRETLAGERSTANDARD		DOWNTUBE BOTTLE MOUNT FLASCHE UNTERROHR
	SEAT POST DIAMETER SÄTTELSTÜTZENDURCHMESSER		

STL CSL TTL HTL HTA STA BB WB ST RE SOH ST DT

LECTOR 1.6 LC U

XS	380	423	550	100.5	69.5	74.6	51	1052	576	391	650	ZS44/ZS56	142/100	Pressfit92	31.6	100	/	/	620	730	35	580	155	/	0.75
----	-----	-----	-----	-------	------	------	----	------	-----	-----	-----	-----------	---------	------------	------	-----	---	---	-----	-----	----	-----	-----	---	------



NEON FLAT // neon yellow / night black

26 LC **LECTOR** KID 1.6



MODEL HIGHLIGHTS

- ▶ Eurobike Award winner
- ▶ Kids' specific race bike
- ▶ True LECTOR features and geometry

MODELL HIGHLIGHTS

- ▶ Eurobike-Award-Gewinner
- ▶ Kinderspezifisches Racebike
- ▶ Echte LECTOR-Features und -Geometrie

LECTOR LC	-	Continental X-King PureGrip 26x2.2 // Continental X-King PureGrip 26x2.2	Fizik Antares R7
XFusion Velvet RL2 100 mm	SRAM NX	Rodi Excalibur XC 2 559x19 mm 32H // Rodi Excalibur XC 2 559x19 mm 32H	16012
GHOST MTB Dia. 31.8 mm	GHOST 28T	Formula DC-71 15x100 mm	PressFit 92 mm
GHOST Low Rizer MTB 580 mm Rise 15 mm Dia. 31.8 mm	SRAM PG-1130 11-42	Formula GHL-360 12x142 mm	FRHG0021
SRAM NX 11-S	Tektro HD-M282 2/2 Piston 160 mm Disc	GHOST Light DC 1 31.6 mm	XS

SIZE	ARTICLENUMBER	NOTES
ONE SIZE	18LE4001	



// KIDS / TOUR

FEATURES



CHARACTERISTICS

- ▶ Trusted kid frame, matches the adult models perfectly
- ▶ Child-friendly saddles and components
- ▶ 24" and 20" models
- ▶ 24" also available with disc brakes

CHARAKTERISTIK

- ▶ Bewährter Kinderrahmen, passt perfekt zu den Erwachsenenmodellen
- ▶ Kindgerechte Sättel und Anbauteile
- ▶ 24"- und 20"-Modelle
- ▶ 24" auch mit Scheibenbremsen erhältlich

TARGET GROUP

- ▶ Kids who want to try the first longer tours with their families

ZIELGRUPPE

- ▶ Kinder, die mit der Familie die ersten längeren Touren angehen möchten



// GEOMETRY AND DATA CHARTS / GEOMETRIE UND TECHNISCHE DATEN

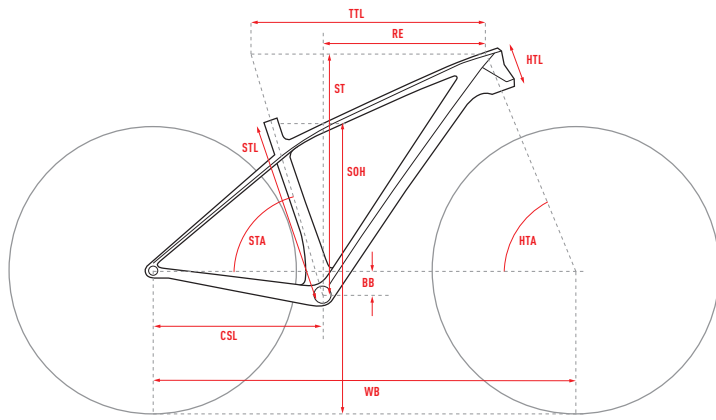

ALL DIMENSIONS IN MM (EXCEPT HTA AND STA IN °)

ALLE MASSE IN MM (AUSNAHME HTA UND STA IN °)

- STL** SEAT TUBE LENGTH
SITZROHRLÄNGE
- CSL** CHAINSTAY LENGTH
KETTENSTREBENLÄNGE
- TTL** TOP TUBE LENGTH
OBERROHRLÄNGE
- HTL** HEADTUBE LENGTH
STEUERROHRLÄNGE
- HTA** HEADTUBE ANGLE
STEUERROHRWINKEL
- STA** SEATTUBE ANGLE
SITZROHRWINKEL
- BB** BB DROP
TRETLAGERABSSENKUNG
- WB** WHEELBASE
RADSTAND
- ST** STACK
STACK
- RE** REACH
REACH
- SOH** STANDOVER HEIGHT
ÜBERSTANDSHÖHE
-  **HEAD SET DIAMETER (UPPER / LOWER)**
STEUERSATZDURCHMESSER (OBEN / UNTEN)
-  **AXLE STANDARD (REAR / FRONT)**
ACHSENSTANDARD (HINTEN / VORNE)
-  **BOTTOM BRACKET STANDARD**
TRETLAGERSTANDARD
-  **SEAT POST DIAMETER**
SITZSTÜTZENDURCHMESSER
-  **SHOCK HARDWARE (Ø 8MM)**
DÄMPFERBUCHSENMASSE (Ø 8MM)
-  **SHOCK LENGTH**
DÄMPFEREINBAULÄNGE
-  **SHOCK TRAVEL**
DÄMPFERHUB
-  **FRONT FORK TRAVEL**
FEDERWEG VORNE
-  **REAR WHEEL TRAVEL**
FEDERWEG HINTEN
-  **MIN SADDLE HEIGHT**
MIN SATTELHÖHE
-  **MAX SADDLE HEIGHT**
MAX SATTELHÖHE
-  **MIN INSEAM**
MIN SCHRITTLÄNGE
-  **MAX INSEAM**
MAX SCHRITTLÄNGE
-  **STEM LENGTH**
VORBAULÄNGE
-  **HANDLEBAR WIDTH**
LENKERBREITE
-  **CRANK LENGTH**
KURBELLENGE
-  **SEATTUBE BOTTLE MOUNT**
FLASCHE SATTELROHR
-  **DOWNTUBE BOTTLE MOUNT**
FLASCHE UNTERROHR

STL CSL TTL HTL HTA STA BB WB ST RE SOH             

KATO KID D4.4 / 2.4 / 2.0 AL U

	STL	CSL	TTL	HTL	HTA	STA	BB	WB	ST	RE	SOH																					
24"	320	415	485	100	71	73	40	955	/	/	550	ZS44/ZS44	135/100	BSA 68	31.6	50	/	/	555	755	60	580	140	/	0.5							
20"	270	355	440	110	73.5	73.5	20	840	/	/	470	ZS34/ZS34	135/100	BSA 68	27.2	50	/	/	485	605	60	520	140	/	/							

KATO KID R1.0 AL U

20"	270	355	440	110	73.5	73.5	20	840	/	/	470	ZS34/ZS34	135/100	BSA 68	27.2	/	/	/	485	605	60	520	140	/	/							
-----	-----	-----	-----	-----	------	------	----	-----	---	---	-----	-----------	---------	--------	------	---	---	---	-----	-----	----	-----	-----	---	---	--	--	--	--	--	--	--



FLAT // night blue / neon yellow / riot blue

24 AL **KATO** D4.4



MODEL HIGHLIGHTS

- ▶ Appealing design for kids
- ▶ Equipped with disc brakes
- ▶ Color option available

MODELL HIGHLIGHTS

- ▶ Optisch ansprechendes Kinderrad
- ▶ Mit Scheibenbremsen
- ▶ Mit Farboption

KATO Kid AL	Shimano Tourney FD-TY500-TS6	Michelin Country Junior 24x1.75 // Michelin Country Junior 24x1.75	BSA 68 mm
RST Capa T 50 mm	Shimano Tourney	Rodi Viper Wheelset 507x21 mm QR // Rodi Viper Wheelset 507x21 mm QR	E22036
GHOST Kid Dia. 31.8 mm	GHOST 38/24	GHOST Light DC 1 31.6 mm	one size
GHOST Low Rizer Kid 580 mm Rise 15 mm Dia. 31.8 mm	Shimano CS-HG-200-8 12-32	GHOST VL 5062	
Shimano Tourney TX.RD-TX800 8-S	Tektro HD-M282 2/2 Piston 160 mm Disc	14106	

SIZE	ARTICLENUMBER	NOTES
ONE SIZE	18KA8001	



MODEL HIGHLIGHTS

- ▶ Appealing design for kids
- ▶ Equipped with disc brakes
- ▶ Color option available

MODELL HIGHLIGHTS

- ▶ Optisch ansprechendes Kinderrad
- ▶ Mit Scheibenbremsen
- ▶ Mit Farboption

KATO Kid AL	Shimano Tourney FD-TY500-TS6	Michelin Country Junior 24x1.75 // Michelin Country Junior 24x1.75	BSA 68 mm
RST Capa T 50 mm	Shimano Tourney	Rodi Viper Wheelset 507x21 mm QR // Rodi Viper Wheelset 507x21 mm QR	EZZ036
GHOST Kid Dia. 31.8 mm	GHOST 38/24	GHOST Light DC 1 31.6 mm	one size
GHOST Low Rizer Kid 580 mm Rise 15 mm Dia. 31.8 mm	Shimano CS-HG-200-8 12-32	GHOST VL 5062	
Shimano Tourney TX RD-TX800 8-S	Tektro HD-M282 2/2 Piston 160 mm Disc	14106	

SIZE	ARTICLENUMBER	NOTES
ONE SIZE	18KA8004	



FLAT // night blue / neon yellow / riot blue

24 AL **KATO** 2.4



MODEL HIGHLIGHTS

- ▶ Shimano components
- ▶ Easy and safe handling with comfortable geometry
- ▶ Color option available

MODELL HIGHLIGHTS

- ▶ Shimano Komponenten
- ▶ Sicheres Handling dank angenehmer Geometrie
- ▶ Mit Farboption

KATO Kid AL	Shimano Tourney FD-TY500-TS6	Michelin Country Junior 24x1.75 // Michelin Country Junior 24x1.75	BSA 68 mm
RST Capa T 50 mm	Shimano Tourney	Rodi Viper Wheelset 507x21 mm QR // Rodi Viper Wheelset 507x21 mm QR	E22036
GHOST Kid Dia. 31.8 mm	GHOST 38/24	GHOST Light DC 1 31.6 mm	one size
GHOST Low Rizer Kid 580 mm Rise 15 mm Dia. 31.8 mm	Shimano CS-HG-200-8 12-32	GHOST VL 5062	
Shimano Tourney TX.RD-TX800 8-S	Tektro 855 AL	14106	

SIZE	ARTICLENUMBER	NOTES
ONE SIZE	18KA7001	



MODEL HIGHLIGHTS

- ▶ Shimano components
- ▶ Easy and safe handling with comfortable geometry
- ▶ Color option available

MODELL HIGHLIGHTS

- ▶ Shimano Komponenten
- ▶ Sicheres Handling dank angenehmer Geometrie
- ▶ Mit Farboption

KATO Kid AL	Shimano Tourney FD-TY500-TS6	Michelin Country Junior 24x1.75 // Michelin Country Junior 24x1.75	BSA 68 mm
RST Capa T 50 mm	Shimano Tourney	Rodi Viper Wheelset 507x21 mm QR // Rodi Viper Wheelset 507x21 mm QR	EZZ036
GHOST Kid Dia. 31.8 mm	GHOST 38/24	GHOST Light DC 1 31.6 mm	one size
GHOST Low Rizer Kid 580 mm Rise 15 mm Dia. 31.8 mm	Shimano CS-HG-200-8 12-32	GHOST VL 5062	
Shimano Tourney TX RD-TX800 8-S	Tektro 855 AL	14106	

SIZE	ARTICLENUMBER	NOTES
ONE SIZE	18KA7004	



FLAT // night blue / neon yellow / riot blue

20 AL **KATO** 2.0



MODEL HIGHLIGHTS

- ▶ Designed for kids who want their first real bike
- ▶ Equipped with suspension fork
- ▶ Easy and safe handling with comfortable geometry

MODELL HIGHLIGHTS

- ▶ Für Kids, die ihr erstes, richtiges Bike wollen
- ▶ Mit Federgabel
- ▶ Sicheres Handling dank angenehmer Geometrie

KATO Kid AL	-	Michelin Country Junior 20x1.75 // Michelin Country Junior 20x1.75	BSA 68 mm
RST Capa T 50 mm	Shimano Tourney	Redi Scout Wheelset 406x21 mm QR // Redi Scout Wheelset 406x21 mm QR	E22036
GHOST Kid Dia. 25.4 mm	GHOST 32T	GHOST Light DC 1 27.2 mm	one size
GHOST Low Rizer Kid 520 mm Rise 20 mm Dia. 25.4 mm	Shimano CS-HG-200-8 12-32	GHOST VL 5062	
Shimano Tourney TX RD-TX800 8-S	Tektro 855 AL	14440	

SIZE	ARTICLENUMBER	NOTES
ONE SIZE	18KA9010	



MODEL HIGHLIGHTS

- ▶ Designed for kids who want their first real bike
- ▶ Equipped with suspension fork
- ▶ Easy and safe handling with comfortable geometry

MODELL HIGHLIGHTS

- ▶ Für Kids, die ihr erstes, richtiges Bike wollen
- ▶ Mit Federgabel
- ▶ Sicheres Handling dank angenehmer Geometrie

KATO Kid AL	-	Michelin Country Junior 20x1.75 // Michelin Country Junior 20x1.75	BSA 68 mm
RST Capa T 50 mm	Shimano Tourney	Rodi Scout Wheelset 406x21 mm DR // Rodi Scout Wheelset 406x21 mm DR	EZ2036
GHOST Kid Dia. 25.4 mm	GHOST 32T	GHOST Light DC 1 27.2 mm	one size
GHOST Low Rizer Kid 520 mm Rise 20 mm Dia. 25.4 mm	Shimano CS-HG-200-8 12-32	GHOST VL 5062	
Shimano Tourney TX RD-TX800 8-S	Tektro 855 AL	14440	

SIZE	ARTICLENUMBER	NOTES
ONE SIZE	18KA9013	



FLAT // night blue / neon yellow / riot blue

20 AL **KATO** R1.0



MODEL HIGHLIGHTS

- ▶ Designed for kids who want their first real bike
- ▶ Easy and safe handling with comfortable geometry
- ▶ Kids-appropriate components

MODELL HIGHLIGHTS

- ▶ Für Kids, die ihr erstes, richtiges Bike wollen
- ▶ Sicheres Handling dank angenehmer Geometrie
- ▶ Kindgerechte Anbauteile

KATO Kid AL	-	Michelin Country Junior 20x1.75 // Michelin Country Junior 20x1.75	BSA 68 mm
GHOST AL 20 Rigid	Shimano Tourney	Redi Scout Wheelset 406x21 mm QR // Redi Scout Wheelset 406x21 mm QR	E22036
GHOST Kid Dia. 25.4 mm	GHOST 32T	GHOST Light DC 1 27.2 mm	one size
GHOST Low Rizer Kid 520 mm Rise 20 mm Dia. 25.4 mm	Shimano CS-HG-200-8 12-32	GHOST VL 5062	
Shimano Tourney TX RD-TX800 8-S	Tektro 855 AL	14440	

SIZE	ARTICLENUMBER	NOTES
ONE SIZE	18KA9001	



MODEL HIGHLIGHTS

- ▶ Designed for kids who want their first real bike
- ▶ Easy and safe handling with comfortable geometry
- ▶ Kids-appropriate components

MODELL HIGHLIGHTS

- ▶ Für Kids, die das erste, richtige Bike wollen
- ▶ Sicheres Handling dank angenehmer Geometrie
- ▶ Kindgerechte Anbauteile

KATO Kid AL	-	Michelin Country Junior 20x1.75 // Michelin Country Junior 20x1.75	BSA 68 mm
GHOST AL 20 Rigid	Shimano Tourney	Rodi Scout Wheelset 406x21 mm DR // Rodi Scout Wheelset 406x21 mm DR	EZZ036
GHOST Kid Dia. 25.4 mm	GHOST 32T	GHOST Light DC 1 27.2 mm	one size
GHOST Low Rizer Kid 520 mm Rise 20 mm Dia. 25.4 mm	Shimano CS-HG-200-8 12-32	GHOST VL 5062	
Shimano Tourney TX RD-TX800 8-S	Tektro 855 AL	14440	

SIZE	ARTICLENUMBER	NOTES
ONE SIZE	18KA9004	



// KIDS / TOUR

FEATURES



CHARACTERISTICS

- ▶ Trusted kid frame, matches the adult models perfectly
- ▶ Child-friendly saddles and components
- ▶ 24" and 20" models
- ▶ 24" also available with disc brakes

CHARAKTERISTIK

- ▶ Bewährter Kinderrahmen, passt perfekt zu den Erwachsenenmodellen
- ▶ Kindgerechte Sättel und Anbauteile
- ▶ 24"- und 20"-Modelle
- ▶ 24" auch mit Scheibenbremsen erhältlich

TARGET GROUP

- ▶ Kids who want to try the first longer tours with their families

ZIELGRUPPE

- ▶ Kinder, die mit der Familie die ersten längeren Touren angehen möchten

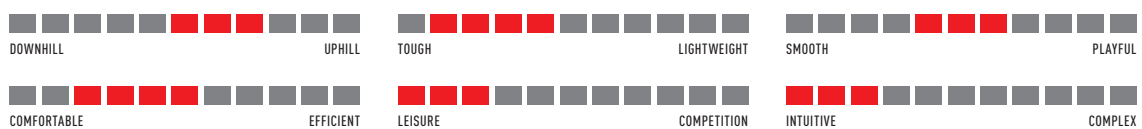



// GEOMETRY AND DATA CHARTS / GEOMETRIE UND TECHNISCHE DATEN

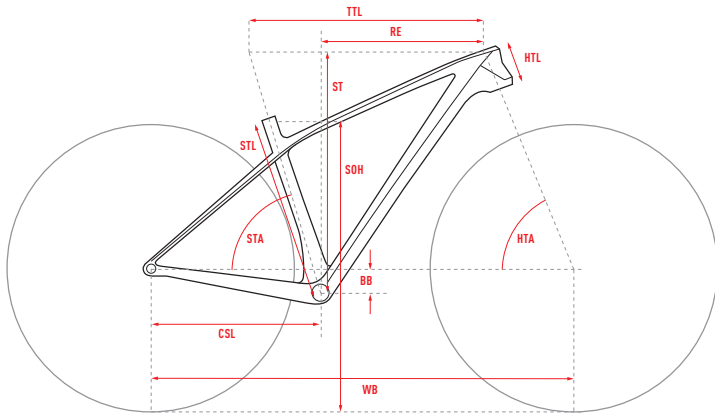

ALL DIMENSIONS IN MM (EXCEPT HTA AND STA IN °)

ALLE MASSE IN MM (AUSNAHME HTA UND STA IN °)

- STL** SEAT TUBE LENGTH
SITZROHRLÄNGE
- CSL** CHAINSTAY LENGTH
KETTENSTREBENLÄNGE
- TTL** TOP TUBE LENGTH
OBERROHRLÄNGE
- HTL** HEADTUBE LENGTH
STEUERROHRLÄNGE
- HTA** HEADTUBE ANGLE
STEUERROHRWINKEL
- STA** SEATTUBE ANGLE
SITZROHRWINKEL
- BB** BB DROP
TRETLAGERABSSENKUNG
- WB** WHEELBASE
RADSTAND
- ST** STACK
STACK
- RE** REACH
REACH
- SOH** STANDOVER HEIGHT
ÜBERSTANDSHÖHE
- HEAD SET DIAMETER (UPPER / LOWER)**
STEUERSATZDURCHMESSER (OBEN / UNTEN)
- AXLE STANDARD (REAR / FRONT)**
ACHSENSTANDARD (HINTEN / VORNE)
- BOTTOM BRACKET STANDARD**
TRETLAGERSTANDARD
- SEAT POST DIAMETER**
SITZSTÜTZENDURCHMESSER
- SHOCK HARDWARE (Ø 8MM)**
DÄMPFERBUCHSENMASSE (Ø 8MM)
- SHOCK LENGTH**
DÄMPFEREINBAULÄNGE
- SHOCK TRAVEL**
DÄMPFERHUB
- FRONT FORK TRAVEL**
FEDERWEG VORNE
- REAR WHEEL TRAVEL**
FEDERWEG HINTEN
- MIN SADDLE HEIGHT**
MIN SATTELHÖHE
- MAX SADDLE HEIGHT**
MAX SATTELHÖHE
- MIN INSEAM**
MIN SCHRITTLÄNGE
- MAX INSEAM**
MAX SCHRITTLÄNGE
- STEM LENGTH**
VORBAULÄNGE
- HANDLEBAR WIDTH**
LENKERBREITE
- CRANK LENGTH**
KURBELLENGE
- SEAT TUBE BOTTLE MOUNT**
FLASCHE SATTELROHR
- DOWN TUBE BOTTLE MOUNT**
FLASCHE UNTERROHR

STL CSL TTL HTL HTA STA BB WB ST RE SOH ST DT

LANAO KID D4.4 / 2.4 / 2.0 AL W

24"	320	415	485	100	71	73	40	955	/	/	530	ZS44/ZS44	135/100	BSA 68	31.6	50	/	/	555	755	60	580	140	/	0.5
20"	270	355	440	110	73.5	73.5	20	840	/	/	442	ZS34/ZS34	135/100	BSA 68	27.2	50	/	/	485	605	60	520	140	/	/

LANAO KID R1.0 AL W

20"	270	355	440	110	73.5	73.5	20	840	/	/	442	ZS34/ZS34	135/100	BSA 68	27.2	/	/	/	485	605	60	520	140	/	/
-----	-----	-----	-----	-----	------	------	----	-----	---	---	-----	-----------	---------	--------	------	---	---	---	-----	-----	----	-----	-----	---	---



SHINY // star white / neon red / juice orange

24 AL **LANAO** D4.4



MODEL HIGHLIGHTS

- ▶ Appealing design for kids
- ▶ Equipped with disc brakes
- ▶ Color option available

MODELL HIGHLIGHTS

- ▶ Optisch ansprechendes Kinderrad
- ▶ Mit Scheibenbremsen
- ▶ Mit Farboption

LANA0 Kid AL	Shimano Tourney FD-TY500-TS6	Michelin Country Junior 24x1.75 // Michelin Country Junior 24x1.75	BSA 68 mm
RST Capa T 50 mm	Shimano Tourney	Rodi Viper Wheelset 507x21 mm QR // Rodi Viper Wheelset 507x21 mm QR	E22036
GHOST MTB Dia. 31.8 mm	GHOST 38/24	GHOST Light DC 1 31.6 mm	one size
GHOST Low Rizer Kid 580 mm Rise 15 mm Dia. 31.8 mm	Shimano CS-HG-200-8 12-32	GHOST VL 5062	
Shimano Tourney TX.RD-TX800 8-S	Tektro HD-M282 2/2 Piston 160 mm Disc	14106	

SIZE	ARTICLENUMBER	NOTES
ONE SIZE	18LA8001	





















MODEL HIGHLIGHTS

- ▶ Appealing design for kids
- ▶ Equipped with disc brakes
- ▶ Color option available

MODELL HIGHLIGHTS

- ▶ Optisch ansprechendes Kinderrad
- ▶ Mit Scheibenbremsen
- ▶ Mit Farboption

 LANA0 Kid AL	 Shimano Tourney FD-TY500-TS6	 Michelin Country Junior 24x1.75 // Michelin Country Junior 24x1.75	 BSA 68 mm
 RST Capa T 50 mm	 Shimano Tourney	 Rodi Viper Wheelset 507x21 mm QR // Rodi Viper Wheelset 507x21 mm QR	 EZZ036
 GHOST MTB Dia. 31.8 mm	 GHOST 38/24	 GHOST Light DC 1 31.6 mm	 one size
 GHOST Low Rizer Kid 580 mm Rise 15 mm Dia. 31.8 mm	 Shimano CS-HG-200-8 12-32	 GHOST VL 5062	
 Shimano Tourney TX RD-TX800 8-S	 Tektro HD-M282 2/2 Piston 160 mm Disc	 14106	

SIZE	ARTICLENUMBER	NOTES
ONE SIZE	18LAB004	



SHINY // star white / neon red / juice orange

24 AL **LANAO 2.4**



MODEL HIGHLIGHTS

- ▶ Shimano components
- ▶ Easy and safe handling with comfortable geometry
- ▶ Color option available

MODELL HIGHLIGHTS

- ▶ Shimano Komponenten
- ▶ Sicheres Handling dank angenehmer Geometrie
- ▶ Mit Farboption

LANAO Kid AL	Shimano Tourney FD-TY500-TS6	Michelin Country Junior 24x1.75 // Michelin Country Junior 24x1.75	BSA 68 mm
RST Capa T 50 mm	Shimano Tourney	Rodi Viper Wheelset 507x21 mm QR // Rodi Viper Wheelset 507x21 mm QR	E22036
GHOST MTB Dia. 31.8 mm	GHOST 38/24	GHOST Light DC 1 31.6 mm	one size
GHOST Low Rizer Kid 580 mm Rise 15 mm Dia. 31.8 mm	Shimano CS-HG-200-8 12-32	GHOST VL 5062	
Shimano Tourney TX.RD-TX800 8-S	Tektro 855 AL	14106	

SIZE	ARTICLENUMBER	NOTES
ONE SIZE	18LA7001	





















MODEL HIGHLIGHTS

- ▶ Shimano components
- ▶ Easy and safe handling with comfortable geometry
- ▶ Color option available

MODELL HIGHLIGHTS

- ▶ Shimano Komponenten
- ▶ Sicheres Handling dank angenehmer Geometrie
- ▶ Mit Farboption

 LANA0 Kid AL	 Shimano Tourney FD-TY500-TS6	 Michelin Country Junior 24x1.75 // Michelin Country Junior 24x1.75	 BSA 68 mm
 RST Capa T 50 mm	 Shimano Tourney	 Rodi Viper Wheelset 507x21 mm QR // Rodi Viper Wheelset 507x21 mm QR	 EZZ036
 GHOST MTB Dia. 31.8 mm	 GHOST 38/24	 GHOST Light DC 1 31.6 mm	 one size
 GHOST Low Rizer Kid 580 mm Rise 15 mm Dia. 31.8 mm	 Shimano CS-HG-200-8 12-32	 GHOST VL 5062	
 Shimano Tourney TX RD-TX800 8-S	 Tektro 855 AL	 14106	

SIZE	ARTICLENUMBER	NOTES
ONE SIZE	18LA7004	



SHINY // star white / neon red / juice orange

20 AL **LANAO 2.0**



MODEL HIGHLIGHTS

- ▶ Designed for kids who want their first real bike
- ▶ Equipped with suspension fork
- ▶ Easy and safe handling with comfortable geometry

MODELL HIGHLIGHTS

- ▶ Für Kids, die ihr erstes, richtiges Bike wollen
- ▶ Mit Federgabel
- ▶ Sicheres Handling dank angenehmer Geometrie

LANA0 Kid AL	-	Michelin Country Junior 20x1.75 // Michelin Country Junior 20x1.75	BSA 68 mm
RST Capa T 50 mm	Shimano Tourney	Redi Scout Wheelset 406x21 mm QR // Redi Scout Wheelset 406x21 mm QR	E22036
GHOST Kid Dia. 25.4 mm	GHOST 32T	GHOST Light DC 1 27.2 mm	one size
GHOST Low Rizer Kid 520 mm Rise 20 mm Dia. 25.4 mm	Shimano CS-HG-200-8 12-32	GHOST VL 5062	
Shimano Tourney TX RD-TX800 8-S	Tektro 855 AL	14440	

SIZE	ARTICLENUMBER	NOTES
ONE SIZE	18LA9010	





















MODEL HIGHLIGHTS

- ▶ Designed for kids who want their first real bike
- ▶ Equipped with suspension fork
- ▶ Easy and safe handling with comfortable geometry

MODELL HIGHLIGHTS

- ▶ Für Kids, die ihr erstes, richtiges Bike wollen
- ▶ Mit Federgabel
- ▶ Sicheres Handling dank angenehmer Geometrie

 LANA0 Kid AL	 -	 Michelin Country Junior 20x1.75 // Michelin Country Junior 20x1.75	 BSA 68 mm
 RST Capa T 50 mm	 Shimano Tourney	 Rodi Scout Wheelset 406x21 mm DR // Rodi Scout Wheelset 406x21 mm DR	 EZZ036
 GHOST Kid Dia. 25.4 mm	 GHOST 32T	 GHOST Light DC 1 27.2 mm	 one size
 GHOST Low Rizer Kid 520 mm Rise 20 mm Dia. 25.4 mm	 Shimano CS-HG-200-8 12-32	 GHOST VL 5062	
 Shimano Tourney TX RD-TX800 8-S	 Tektro 855 AL	 14440	

SIZE	ARTICLENUMBER	NOTES
ONE SIZE	18LA9013	



SHINY // star white / neon red / juice orange

20 AL **LANAO** R1.0



MODEL HIGHLIGHTS

- ▶ Designed for kids who want their first real bike
- ▶ Easy and safe handling with comfortable geometry
- ▶ Safe handling thanks to comfortable geometry

MODELL HIGHLIGHTS

- ▶ Für Kids, die ihr erstes, richtiges Bike wollen
- ▶ Sicheres Handling dank angenehmer Geometrie
- ▶ Kindgerechte Anbauteile

LANA0 Kid AL	-	Michelin Country Junior 20x1.75 // Michelin Country Junior 20x1.75	BSA 68 mm
GHOST AL 20 Rigid	Shimano Tourney	Redi Scout Wheelset 406x21 mm QR // Redi Scout Wheelset 406x21 mm QR	E22036
GHOST Kid Dia. 25.4 mm	GHOST 32T	GHOST Light DC 1 27.2 mm	one size
GHOST Low Rizer Kid 520 mm Rise 20 mm Dia. 25.4 mm	Shimano CS-HG-200-8 12-32	GHOST VL 5062	
Shimano Tourney TX RD-TX800 8-S	Tektro 855 AL	14440	

SIZE	ARTICLENUMBER	NOTES
ONE SIZE	18LA9001	





















MODEL HIGHLIGHTS

- ▶ Designed for kids who want their first real bike
- ▶ Easy and safe handling with comfortable geometry
- ▶ Safe handling thanks to comfortable geometry

MODELL HIGHLIGHTS

- ▶ Für Kids, die das erste, richtige Bike wollen
- ▶ Sicheres Handling dank angenehmer Geometrie
- ▶ Kindgerechte Anbauteile

 LANA0 Kid AL	 -	 Michelin Country Junior 20x1.75 // Michelin Country Junior 20x1.75	 BSA 68 mm
 GHOST AL 20 Rigid	 Shimano Tourney	 Rodi Scout Wheelset 406x21 mm DR // Rodi Scout Wheelset 406x21 mm DR	 EZZ036
 GHOST Kid Dia. 25.4 mm	 GHOST 32T	 GHOST Light DC 1 27.2 mm	 one size
 GHOST Low Rizer Kid 520 mm Rise 20 mm Dia. 25.4 mm	 Shimano CS-HG-200-8 12-32	 GHOST VL 5062	
 Shimano Tourney TX RD-TX800 8-S	 Tektro 855 AL	 14440	

SIZE	ARTICLENUMBER	NOTES
ONE SIZE	18LA9004	



+ CHILD-FRIENDLY DESIGN // KINDGERECHTE GESTALTUNG

+ HANDLEBAR WITH RUBBER PADS // LENKERENDEN MIT GUMMIPUFFER

// KIDS / ENTRY

FEATURES



CHARACTERISTICS

- ▶ 16" and 12" models
- ▶ Comfortable saddles, focus on safety
- ▶ With training wheels and pennant

CHARAKTERISTIK

- ▶ 16"- und 12"-Modelle
- ▶ Bequeme Sättel, Augenmerk auf Sicherheit
- ▶ Mit Stützrädern und Wimpel

TARGET GROUP

- ▶ A complete package for kids as they learn to pedal for the first time

ZIELGRUPPE

- ▶ Ein komplettes Paket für Kinder, die das erste Mal in die Pedale treten



POWERKID

// GEOMETRY AND DATA CHARTS / GEOMETRIE UND TECHNISCHE DATEN

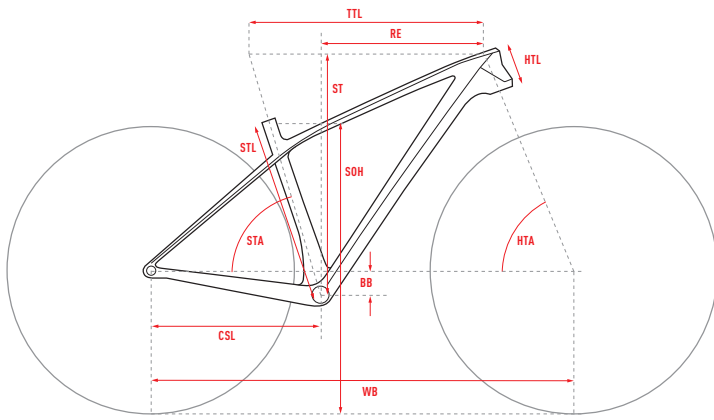

ALL DIMENSIONS IN MM (EXCEPT HTA AND STA IN °)

ALLE MASSE IN MM (AUSNAHME HTA UND STA IN °)

- STL** SEAT TUBE LENGTH
SITZROHRLÄNGE
- CSL** CHAINSTAY LENGTH
KETTENSTREBENLÄNGE
- TTL** TOP TUBE LENGTH
OBERROHRLÄNGE
- HTL** HEADTUBE LENGTH
STEUERROHRLÄNGE
- HTA** HEADTUBE ANGLE
STEUERROHRWINKEL
- STA** SEATTUBE ANGLE
SITZROHRWINKEL
- BB** BB DROP
TRETLAGERABSSENKUNG
- WB** WHEELBASE
RADSTAND
- ST** STACK
STACK
- RE** REACH
REACH
- SOH** STANDOVER HEIGHT
ÜBERSTANDSHÖHE
- HEAD SET DIAMETER (UPPER / LOWER)
STEUERSATZDURCHMESSER (OBEN / UNTEN)
- AXLE STANDARD (REAR / FRONT)
ACHSENSTANDARD (HINTEN / VORNE)
- BOTTOM BRACKET STANDARD
TRETLAGERSTANDARD
- SEAT POST DIAMETER
SITZSTÜTZENDURCHMESSER
- SHOCK HARDWARE (Ø 8MM)
DÄMPFERBUCHSENMASSE (Ø 8MM)
- SHOCK LENGTH
DÄMPFEREINBAULÄNGE
- SHOCK TRAVEL
DÄMPFERHUB
- FRONT FORK TRAVEL
FEDERWEG VORNE
- REAR WHEEL TRAVEL
FEDERWEG HINTEN
- MIN SADDLE HEIGHT
MIN SÄTTELHÖHE
- MAX SADDLE HEIGHT
MAX SÄTTELHÖHE
- MIN INSEAM
MIN SCHRITTLÄNGE
- MAX INSEAM
MAX SCHRITTLÄNGE
- STEM LENGTH
VORBAULÄNGE
- HANDLEBAR WIDTH
LENKERBREITE
- CRANK LENGTH
KURBELLÄNGE
- SEAT TUBE BOTTLE MOUNT
FLASCHE SÄTTELROHR
- DOWNTUBE BOTTLE MOUNT
FLASCHE UNTERROHR

STL CSL TTL HTL HTA STA BB WB ST RE SOH

POWERKID AL 16 / 12 AL U

16"	230	315	380	100	71	73	-3	725	/	/	395	ZS30/ZS30	110/100	BSA 68	27.2	/	510	570	410	470	30	460	114	/	/
12"	180	240	315	100	71	73	-8	595	/	/	340	ZS30/ZS30	110/100	BSA 68	27.2	/	410	470	350	400	30	460	89	/	/



SHINY // star white / riot blue / dark fuchsia pink



MODEL HIGHLIGHTS

- ▶ Safety features include pennant, grips and training wheels
- ▶ Designed for kids

MODELL HIGHLIGHTS

- ▶ Sicherheitsfeatures: Wimpel, Griffe, Stützräder
- ▶ Kindgerechtes Design

POWERKID AL	-	Kenda 16 // Kenda 16	Velo
GHOST AL 16 Rigid	-	AL 16 // AL 16	-
GHOST POWERKID	GHOST POWERKID	Joytech/KT	-
GHOST POWERKID	-	Joytech/KT	one size
-	Front: V-brake, Rear: back pedal brake	Leadtec	

SIZE	ARTICLENUMBER	NOTES
ONE SIZE	18PK1008	



MODEL HIGHLIGHTS

- ▶ Safety features include pennant, grips and training wheels
- ▶ Designed for kids

MODELL HIGHLIGHTS

- ▶ Sicherheitsfeatures: Wimpel, Griffe, Stützräder
- ▶ Kindgerechtes Design

POWERKID AL	-	Kenda 16 // Kenda 16	Velo
GHOST AL 16 Rigid	-	AL 16 // AL 16	-
GHOST POWERKID	GHOST POWERKID	Joytech/KT	-
GHOST POWERKID	-	Joytech/KT	one size
-	Front: V-brake, Rear: back pedal brake	Leadtec	

SIZE	ARTICLENUMBER	NOTES
ONE SIZE	18PK1007	



SHINY // night black / riot blue / star white



MODEL HIGHLIGHTS

- ▶ Safety features include pennant, grips and training wheels
- ▶ Designed for kids

MODELL HIGHLIGHTS

- ▶ Sicherheitsfeatures: Wimpel, Griffe, Stützräder
- ▶ Kindgerechtes Design

POWERKID AL	-	Kenda 16 // Kenda 16	Velo
GHOST AL 16 Rigid	-	AL 16 // AL 16	-
GHOST POWERKID	GHOST POWERKID	Joytech/KT	-
GHOST POWERKID	-	Joytech/KT	one size
-	Front: V-brake, Rear: back pedal brake	Leadtec	

SIZE	ARTICLENUMBER	NOTES
ONE SIZE	18PK1010	



MODEL HIGHLIGHTS

- ▶ Safety features include pennant, grips and training wheels
- ▶ Designed for kids

MODELL HIGHLIGHTS

- ▶ Sicherheitsfeatures: Wimpel, Griffe, Stützräder
- ▶ Kindgerechtes Design

POWERKID AL	-	Kenda 16 // Kenda 16	Velo
GHOST AL 16 Rigid	-	AL 16 // AL 16	-
GHOST POWERKID	GHOST POWERKID	Joytech/KT	-
GHOST POWERKID	-	Joytech/KT	one size
-	Front: V-brake, Rear: back pedal brake	Leadtec	

SIZE	ARTICLENUMBER	NOTES
ONE SIZE	18PK1009	



SHINY // riot green / cane yellow / riot red



MODEL HIGHLIGHTS

- ▶ Safety features include pennant, grips and training wheels
- ▶ Designed for kids

MODELL HIGHLIGHTS

- ▶ Sicherheitsfeatures: Wimpel, Griffe, Stützräder
- ▶ Kindgerechtes Design

POWERKID AL	-	Kenda 12 // Kenda 12	Velo
GHOST AL 12 Rigid	-	AL 12 // AL 12	-
GHOST POWERKID	GHOST POWERKID	Joytech/KT	-
GHOST POWERKID	-	Joytech/KT	one size
-	Front: V-brake, Rear: back pedal brake	Leadtec	

SIZE	ARTICLENUMBER	NOTES
ONE SIZE	18PK1003	





















MODEL HIGHLIGHTS

- ▶ Safety features include pennant, grips and training wheels
- ▶ Designed for kids

MODELL HIGHLIGHTS

- ▶ Sicherheitsfeatures: Wimpel, Griffe, Stützräder
- ▶ Kindgerechtes Design

 POWERKID AL	 -	 Kenda 12 // Kenda 12	 Velo
 GHOST AL 12 Rigid	 -	 AL 12 // AL 12	 -
 GHOST POWERKID	 GHOST POWERKID	 Joytech/KT	 -
 GHOST POWERKID	 -	 Joytech/KT	 one size
 -	 Front: V-brake, Rear: back pedal brake	 Leadtec	

SIZE	ARTICLENUMBER	NOTES
ONE SIZE	18PK1006	



SHINY // juice orange / riot red / riot blue



MODEL HIGHLIGHTS

- ▶ Safety features include pennant, grips and training wheels
- ▶ Designed for kids

MODELL HIGHLIGHTS

- ▶ Sicherheitsfeatures: Wimpel, Griffe, Stützräder
- ▶ Kindgerechtes Design

POWERKID AL	-	Kenda 12 // Kenda 12	Velo
GHOST AL 12 Rigid	-	AL 12 // AL 12	-
GHOST POWERKID	GHOST POWERKID	Joytech/KT	-
GHOST POWERKID	-	Joytech/KT	one size
-	Front: V-brake, Rear: back pedal brake	Leadtec	

SIZE	ARTICLENUMBER	NOTES
ONE SIZE	18PK1004	





















MODEL HIGHLIGHTS

- ▶ Safety features include pennant, grips and training wheels
- ▶ Designed for kids

MODELL HIGHLIGHTS

- ▶ Sicherheitsfeatures: Wimpel, Griffe, Stützräder
- ▶ Kindgerechtes Design

 POWERKID AL	 -	 Kenda 12 // Kenda 12	 Velo
 GHOST AL 12 Rigid	 -	 AL 12 // AL 12	 -
 GHOST POWERKID	 GHOST POWERKID	 Joytech/KT	 -
 GHOST POWERKID	 -	 Joytech/KT	 one size
 -	 Front: V-brake, Rear: back pedal brake	 Leadtec	

SIZE	ARTICLENUMBER	NOTES
ONE SIZE	18PK1005	

POWERKIDDY



// KIDS / ENTRY

FEATURES



CHARACTERISTICS

- ▶ 12" balance bike
- ▶ Comfortable and safe
- ▶ Trusted and popular for years

CHARAKTERISTIK

- ▶ 12"-LaufRAD
- ▶ Bequem und sicher
- ▶ Seit Jahren bewährt und beliebt

TARGET GROUP

- ▶ The first set of two-wheels

ZIELGRUPPE

- ▶ Das erste Zweirad



POWERKIDDY

// GEOMETRY AND DATA CHARTS / GEOMETRIE UND TECHNISCHE DATEN

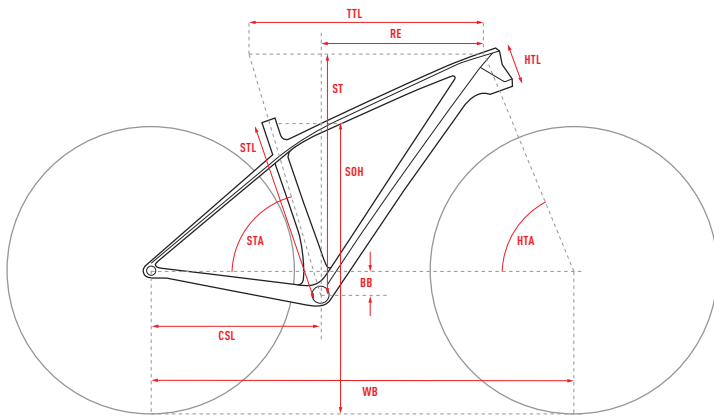

ALL DIMENSIONS IN MM (EXCEPT HTA AND STA IN °)

ALLE MASSE IN MM (AUSNAHME HTA UND STA IN °)

STL	SEAT TUBE LENGTH SITZROHRLÄNGE		SHOCK HARDWARE (Ø 8MM) DÄMPFERBUCHSENMASSE (Ø 8MM)
CSL	CHAINSTAY LENGTH KETTENSTREBENLÄNGE		SHOCK LENGTH DÄMPFEREINBAULÄNGE
TTL	TOP TUBE LENGTH OBERROHRLÄNGE		SHOCK TRAVEL DÄMPFERHUB
HTL	HEADTUBE LENGTH STEUERROHRLÄNGE		FRONT FORK TRAVEL FEDERWEG VORNE
HTA	HEADTUBE ANGLE STEUERROHRWINKEL		REAR WHEEL TRAVEL FEDERWEG HINTEN
STA	SEATTUBE ANGLE SITZROHRWINKEL		MIN SADDLE HEIGHT MIN SÄTTELHÖHE
BB	BB DROP TRETLAGERABSSENKUNG		MAX SADDLE HEIGHT MAX SÄTTELHÖHE
WB	WHEELBASE RADSTAND		MIN INSEAM MIN SCHRITTLÄNGE
ST	STACK STACK		MAX INSEAM MAX SCHRITTLÄNGE
RE	REACH REACH		STEM LENGTH VORBAULÄNGE
SOH	STANDOVER HEIGHT ÜBERSTANDSHÖHE		HANDLEBAR WIDTH LENKERBREITE
	HEAD SET DIAMETER (UPPER / LOWER) STEUERSATZDURCHMESSER (OBEN / UNTEN)		CRANK LENGTH KURBELLÄNGE
	AXLE STANDARD (REAR / FRONT) ACHSENSTANDARD (HINTEN / VORNE)		SEATTUBE BOTTLE MOUNT FLASCHE SÄTTELROHR
	BOTTOM BRACKET STANDARD TRETLAGERSTANDARD		DOWNTUBE BOTTLE MOUNT FLASCHE UNTERROHR
	SEAT POST DIAMETER SÄTTELSTÜTZENDURCHMESSER		

STL CSL TTL HTL HTA STA BB WB ST RE SOH ST DT

POWERKIDDY AL 12 AL U

12"	165	295	300	60	72	72	/	563	/	/	350	ZS30/ZS30	100/100	/	27.2	/	365	430	/	/	35	460	/	/	/
-----	-----	-----	-----	----	----	----	---	-----	---	---	-----	-----------	---------	---	------	---	-----	-----	---	---	----	-----	---	---	---



SHINY // violet / star white / fuchsia pink



MODEL HIGHLIGHTS

- ▶ Frame designed with footrest
- ▶ Narrow handlebar with safety grips
- ▶ Designed for kids

MODELL HIGHLIGHTS

- ▶ Auflagefläche für Füße
- ▶ Schmäler Lenker mit Sicherheitsgriffen
- ▶ Kindgerechtes Design

POWERKIDDY AL	-	Kenda 12 // Kenda 12	Velo
GHOST AL 12 Rigid	-	AL 12 // AL 12	-
GHOST POWERKIDDY	-	Joytech/KT	-
GHOST POWERKIDDY	-	Joytech/KT	one size
-	-	Leadtec	

SIZE	ARTICLENUMBER	NOTES
ONE SIZE	18PK1002	



MODEL HIGHLIGHTS

- ▶ Frame designed with footrest
- ▶ Narrow handlebar with safety grips
- ▶ Designed for kids

MODELL HIGHLIGHTS

- ▶ Auflagefläche für Füße
- ▶ Schmäler Lenker mit Sicherheitsgriffen
- ▶ Kindgerechtes Design

POWERKIDDY AL	-	Kenda 12 // Kenda 12	Velo
GHOST AL 12 Rigid	-	AL 12 // AL 12	-
GHOST POWERKIDDY	-	Joytech/KT	-
GHOST POWERKIDDY	-	Joytech/KT	one size
-	-	Leadtec	

SIZE	ARTICLENUMBER	NOTES
ONE SIZE	18PK1001	

LECTOR X



+ EXTREMELY LIGHT TOTAL WEIGHT THANKS TO THE GHOST CARBON RIGID FORK // EXTREM LEICHTES GESAMTGEWICHT DANK GHOST CARBON-STARRGABEL

+ ALL-NEW DEVELOPMENT BASED ON THE DNA OF OUR RENOWNED AND SUCCESSFUL LECTOR RACE HARDTAIL // NEUENTWICKLUNG AUF BASIS DER DNA UNSERES RENOMMIERTEN UND ERFOLGSVERWÖHNTE LECTOR RACE-HARDTAILS

+ INTELLIGENT TIRE CHOICE FOR LOW WEIGHT AND ROLLING RESISTANCE // REIFEN AUF NIEDRIGES GEWICHT UND ROLLWIDERSTAND ABGESTIMMT

+ HYBRIDE MX CONCEPT: 29"/27.5"- MIX: PERFECTLY TUNED FOR RIDING STABILITY AND TRACTION // HYBRIDE MXER CONCEPT: 29"/27.5"- MIX FÜR PERFEKT ABGESTIMMTE FAHRSTABILITÄT UND TRAKTION

+ SET-UP WITHOUT COMPROMISE FOR STRIKING EFFICIENCY // KOMPROMISSLOSES SET-UP FÜR BESTECHENDE EFFIZIENZ

// ALLROAD / SPEED

FEATURES



CHARACTERISTICS

- ▶ Carbon frame with integrated powerful 504 Wh battery and Shimano Steps 8000 motor with up to 70 Nm torque at less than 2,9 kg
- ▶ Absolute benchmark product in its class
- ▶ Exclusive equipment and looks
- ▶ Ultralight with 17 kg

CHARAKTERISTIK

- ▶ Carbonrahmen mit integriertem 504 Wh Akku und Shimano Steps 8000 Motor mit max. 70 Nm Drehmoment bei unter 2,9 kg
- ▶ Absolutes Benchmark-Produkt seiner Klasse
- ▶ Exklusive Ausstattung und Optik
- ▶ Extrem leicht mit 17 kg

TARGET GROUP

- ▶ For E-bikers who don't subject to conventions and value exclusivity and elegance

ZIELGRUPPE

- ▶ Für E-Biker, die sich keinen Konventionen unterwerfen möchten und Exklusivität und Eleganz zu schätzen wissen



LECTOR X

// GEOMETRY AND DATA CHARTS / GEOMETRIE UND TECHNISCHE DATEN

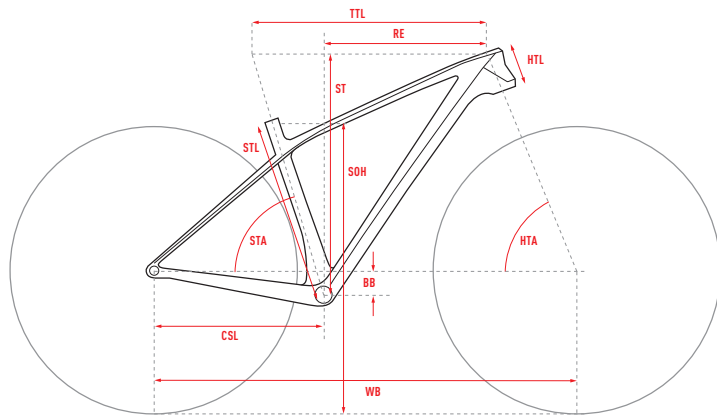

ALL DIMENSIONS IN MM (EXCEPT HTA AND STA IN °)

ALLE MASSE IN MM (AUSNAHME HTA UND STA IN °)

- STL** SEAT TUBE LENGTH
SITZROHRLÄNGE
- CSL** CHAINSTAY LENGTH
KETTENSTREBENLÄNGE
- TTL** TOP TUBE LENGTH
OBERROHRLÄNGE
- HTL** HEADTUBE LENGTH
STEUERROHRLÄNGE
- HTA** HEADTUBE ANGLE
STEUERROHRWINKEL
- STA** SEATTUBE ANGLE
SITZROHRWINKEL
- BB** BB DROP
TRETLAGERABSSENKUNG
- WB** WHEELBASE
RADSTAND
- ST** STACK
STACK
- RE** REACH
REACH
- SOH** STANDOVER HEIGHT
ÜBERSTANDSHÖHE
- SD** HEAD SET DIAMETER (UPPER / LOWER)
STEUERSATZDURCHMESSER (OBEN / UNTEN)
- AS** AXLE STANDARD (REAR / FRONT)
ACHSENSTANDARD (HINTEN / VORNE)
- BS** BOTTOM BRACKET STANDARD
TRETLAGERSTANDARD
- SD** SEAT POST DIAMETER
SITZELSTÜTZENDURCHMESSER
- SH** SHOCK HARDWARE (Ø 8MM)
DÄMPFERBUCHSENMASSE (Ø 8MM)
- SL** SHOCK LENGTH
DÄMPFEREINBAULÄNGE
- ST** SHOCK TRAVEL
DÄMPFERHUB
- FF** FRONT FORK TRAVEL
FEDERWEG VORNE
- FR** REAR WHEEL TRAVEL
FEDERWEG HINTEN
- SH** MIN SADDLE HEIGHT
MIN SITZTELHÖHE
- SH** MAX SADDLE HEIGHT
MAX SITZTELHÖHE
- SH** MIN INSEAM
MIN SCHRITTLÄNGE
- SH** MAX INSEAM
MAX SCHRITTLÄNGE
- SL** STEM LENGTH
VORBAULÄNGE
- SH** HANDLEBAR WIDTH
LENKERBREITE
- SL** CRANK LENGTH
KURBELLENGE
- ST** SEATTUBE BOTTLE MOUNT
FLASCHE SATTELROHR
- DT** DOWNTUBE BOTTLE MOUNT
FLASCHE UNTERROHR

STL CSL TTL HTL HTA STA BB WB ST RE SOH

HYBRIDE LECTOR X S5.7+ LC U

	STL	CSL	TTL	HTL	HTA	STA	BB	WB	ST	RE	SOH																	
S	380	440	593	100	68.1	75.6	76	1142	604	438	676	ZS44/ZS56	148/110	/	31.6	/	/	/	/	/	/	/	/	60	740	170	0.5	/
M	420	440	609	105	68.1	75.6	76	1158	608	453	688	ZS44/ZS56	148/110	/	31.6	/	/	/	/	/	/	/	60	740	170	0.6	/	
L	460	440	633	120	68.1	75.6	76	1184	622	473	713	ZS44/ZS56	148/110	/	31.6	/	/	/	/	/	/	/	60	740	170	0.6	/	



FLAT // titanium gray / night black / neon yellow

LECTOR X S5.7+



MODEL HIGHLIGHTS

- ▶ GHOST LECTOR carbon rigid fork
- ▶ Thought-out component choice
- ▶ MX concept: 29" front, 27.5"+ rear wheels
- ▶ Ultralight with 17 kg

MODELL HIGHLIGHTS

- ▶ GHOST LECTOR Carbon-Starrgabel
- ▶ Durchdachte Komponentenwahl
- ▶ MX-Konzept: 29" vorn, 27.5"+ hinten
- ▶ Extrem leicht mit 17 kg

Hybride LECTOR LC	Shimano SLX SL-M7000	Formula DC-711 15x110 mm	Shimano BT-E8010 504 Wh
GHOST LC Rigid Fork	Ground Fiftyone 38T	Formula EHL-148A 12x148 mm	Shimano EC-E6000
Ground Fiftyone Dia. 31.8 mm	Sunrace MS8-E 11-46	Ground Fiftyone Team Carbon 31.6 mm	16012
Ground Fiftyone Team 740 mm Dia. 31.8 mm	Shimano SLX BR-M7000 180 mm Disc	Fizik Antares R7	FRH60021
Shimano SLX RD-M7000 Shadow Plus 11-S	Maxxis Ikon 3C MaxxSpeed Exo 29x2.35 // Maxxis Ikon 3C MaxxSpeed Exo 27.5x2.8	Shimano SC-E8000	S-M-L
Rodri Tryp 622x30mm 32H // Rodri Tryp 584x30mm 32H	Shimano DU-E8000		

SIZE	ARTICLENUMBER	NOTES
SIZE S	18YC1001	
SIZE M	18YC1002	
SIZE L	18YC1003	

LECTOR



+ ALL-NEW DEVELOPMENT BASED ON THE DNA OF OUR RENOWNED AND SUCCESSFUL LECTOR RACE HARDTAIL // NEUENTWICKLUNG AUF BASIS DER DNA UNSERES RENOMMIERTEN UND ERFOLGSVERWÖHNTEN LECTOR RACE-HARDTAILS

+ LC CARBON FRAME WITH INTEGRATED BATTERY FOR ATHLETIC EDGY LOOKS // LC-CARBONRAHMEN MIT INTEGRIERTEM AKKU FÜR EINE SPORTLICH SCHNITTIGE OPTIK

+ INTELLIGENT TIRE CHOICE FOR LOW WEIGHT AND ROLLING RESISTANCE // REIFEN ABGESTIMMT AUF NIEDRIGES GEWICHT UND ROLLWIDERSTAND

+ HYBRIDE MX CONCEPT: 29" / 27.5" + MIX: PERFECTLY TUNED FOR RIDING STABILITY AND TRACTION // HYBRIDE MXER CONCEPT: 29" / 27.5" + MIX FÜR PERFEKT ABGESTIMMTE FAHRSTABILITÄT UND TRAKTION

+ E-BIKE SPECIFIC COMPONENTS // E-BIKE-SPEZIFISCHE KOMponentEN

// XC / TOUR

FEATURES

LC
27.5⁺
F 120 / R 0
8000 STEPS
FEM
MXer CONCEPT

CHARACTERISTICS

- ▶ Carbon frame with integrated powerful 504 Wh battery and Shimano Steps 8000 motor with up to 70 Nm torque at less than 2.9 kg
- ▶ Super lightweight carbon hardtail with E-bike specific equipment for long-lasting riding fun
- ▶ Cross Country tours and gravel newly defined
- ▶ A genuine E-allrounder with strikingly superior riding qualities for maximum riding fun

CHARAKTERISTIK

- ▶ Carbonrahmen mit integriertem 504 Wh Akku und Shimano Steps 8000 Motor mit max. 70 Nm Drehmoment bei unter 2,9 kg
- ▶ Super leichtes Carbon-Hardtail mit E-Bike- spezifischer Ausstattung für langanhaltende Fahrfreude
- ▶ Definiert Cross Country-Touren und Gravel neu
- ▶ Ein waschechter E-Allrounder mit bestechend souveränen Fahrqualitäten für maximalen Fahrspaß

TARGET GROUP

- ▶ For E-bikers who value sports as much as they do exclusivity and the charm of a strong personality

ZIELGRUPPE

- ▶ Für E-Biker, denen Sportlichkeit ebenso wichtig ist wie Exklusivität und charakterstarke Ausstrahlung



LECTOR

// GEOMETRY AND DATA CHARTS / GEOMETRIE UND TECHNISCHE DATEN

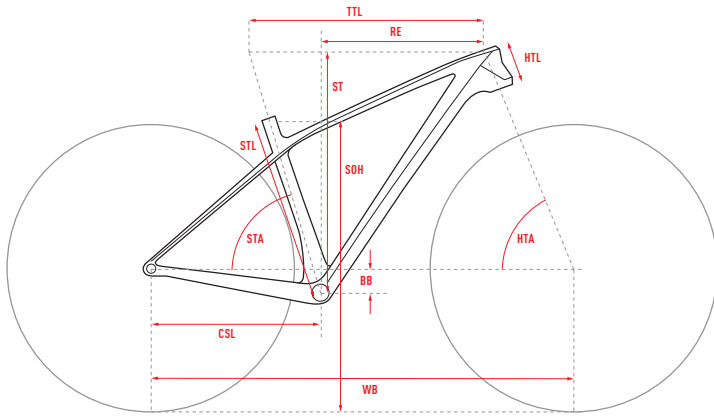

ALL DIMENSIONS IN MM (EXCEPT HTA AND STA IN °)

ALLE MASSE IN MM (AUSNAHME HTA UND STA IN °)

- STL** SEAT TUBE LENGTH
SITZROHRLÄNGE
- CSL** CHAINSTAY LENGTH
KETTENSTREBENLÄNGE
- TTL** TOP TUBE LENGTH
OBERROHRLÄNGE
- HTL** HEADTUBE LENGTH
STEUERROHRLÄNGE
- HTA** HEADTUBE ANGLE
STEUERROHRWINKEL
- STA** SEATTUBE ANGLE
SITZROHRWINKEL
- BB** BB DROP
TRETLAGERABSENKUNG
- WB** WHEELBASE
RADSTAND
- ST** STACK
STACK
- RE** REACH
REACH
- SOH** STANDOVER HEIGHT
ÜBERSTANDSHÖHE
- HSD** HEAD SET DIAMETER (UPPER / LOWER)
STEUERSATZDURCHMESSER (OBEN / UNTEN)
- AS** AXLE STANDARD (REAR / FRONT)
ACHSENSTANDARD (HINTEN / VORNE)
- BS** BOTTOM BRACKET STANDARD
TRETLAGERSTANDARD
- SPD** SEAT POST DIAMETER
SITTELSTÜTZENDURCHMESSER
- SHW** SHOCK HARDWARE (Ø 8MM)
DÄMPFERBUCHSENMASSE (Ø 8MM)
- SL** SHOCK LENGTH
DÄMPFEREINBAULÄNGE
- STV** SHOCK TRAVEL
DÄMPFERHUB
- FV** FRONT FORK TRAVEL
FEDERWEG VORNE
- RV** REAR WHEEL TRAVEL
FEDERWEG HINTEN
- MSH** MIN SADDLE HEIGHT
MIN SITTELHÖHE
- MSHx** MAX SADDLE HEIGHT
MAX SITTELHÖHE
- MSL** MIN INSEAM
MIN SCHRITTLÄNGE
- MSLx** MAX INSEAM
MAX SCHRITTLÄNGE
- SLV** STEM LENGTH
VORBAULÄNGE
- HL** HANDLEBAR WIDTH
LENKERBREITE
- CL** CRANK LENGTH
KURBELLÄNGE
- SM** SEATTUBE BOTTLE MOUNT
FLASCHE SITTELROHR
- DM** DOWNTUBE BOTTLE MOUNT
FLASCHE UNTERROHR

STL CSL TTL HTL HTA STA BB WB ST RE SOH

HYBRIDE LECTOR S8.7+ LC U

	S	M	L
STL	380	420	460
CSL	442.7	442.7	442.7
TTL	600	616	640
HTL	100	105	120
HTA	65.8	65.8	65.8
STA	73.3	73.3	73.3
BB	59	59	59
WB	1161	1178	1204
ST	621	626	640
RE	413	428	448
SOH	693	706	730
HSD	ZS44/ZS56	ZS44/ZS56	ZS44/ZS56
AS	148/PS	148/PS	148/PS
BS	/	/	/
SPD	31.6	31.6	31.6
SHW	/	/	/
SL	/	/	/
STV	/	/	/
FV	120	120	120
RV	/	/	/
MSH	50	50	50
MSHx	780	780	780
MSL	170	170	170
MSLx	0.5	0.6	0.6

HYBRIDE LECTOR S6.7+ / S4.7+ LC U

	S	M	L
STL	380	420	460
CSL	442.7	442.7	442.7
TTL	600	616	640
HTL	100	105	120
HTA	65.8	65.8	65.8
STA	73.3	73.3	73.3
BB	59	59	59
WB	1161	1178	1204
ST	621	626	640
RE	413	428	448
SOH	693	706	730
HSD	ZS44/ZS56	ZS44/ZS56	ZS44/ZS56
AS	148/110	148/110	148/110
BS	/	/	/
SPD	31.6	31.6	31.6
SHW	/	/	/
SL	/	/	/
STV	/	/	/
FV	120	120	120
RV	/	/	/
MSH	55	55	55
MSHx	760	760	760
MSL	165	165	165
MSLx	0.5	0.6	0.6



FLAT // titanium gray / volcano orange / palladium silver

LECTOR S8.7+



MODEL HIGHLIGHTS

- ▶ Top-end components
- ▶ Powerful Shimano Saint disc brakes
- ▶ One of the lightest E-bikes outthere

MODELL HIGHLIGHTS

- ▶ Edle und hochwertige Anbauteile
- ▶ Standfeste Shimano Saint Bremsanlage
- ▶ Eines der leichtesten E-Bikes überhaupt

Hybride LECTOR LC	Shimano XTR DI2 SW-M9050	Kind Shock LEV Integra 31,6 mm	16012
Rock Shox RS1 120 mm	Ground Fiftyone 38T	Fizik Antares R7	FRH0022
Syntace Megaforce2 Dia. 31,8 mm	Shimano XT CS-M8000 11-46	Shimano SC-E8000	S-M-L
Syntace Vector 780 mm Rise 20 mm Dia. 31,8 mm	Shimano Saint BR-M820 4/4 Piston 203 mm Disc	Shimano DU-E8000	
Shimano XTR DI2 RD-M9050 11-S	Maxxis Ardent 3C MaxxTerra Exo 29x2.35 // Maxxis Rekon 3C MaxxTerra Exo 27.5x2.8	Shimano BT-E8010 504 Wh	
-	DT Swiss XR 1501 Spline One 25 mm Wheelset 15x110 mm // DT Swiss XR 1501 Spline One 25 mm Wheelset 12x148 mm	Shimano EC-E6000	

SIZE	ARTICLENUMBER	NOTES
SIZE S	18YC1019	
SIZE M	18YC1020	
SIZE L	18YC1021	























MODEL HIGHLIGHTS

- ▶ DT Swiss H 1900 E-bike specific wheelset
- ▶ SRAM EX1 8-speed E-bike drivetrain
- ▶ Rock Shox Pike fork

MODELL HIGHLIGHTS

- ▶ DT Swiss H 1900 E-Bike-Laufräder
- ▶ SRAM EX1 E-Bike 8-Gang Schaltgruppe
- ▶ Rock Shox Pike Federgabel

 Hybride LECTOR LC	 SRAM EX1	 Kind Shock LEV Integra 31.6 mm	 16012
 Rock Shox Pike RC Debon Air 120 mm	 Ground Fiftyone 34T	 Fizik Antares R7	 FRHG0021
 Ground Fiftyone Team Dia. 35 mm	 SRAM XG 899 11-48	 Shimano SC-E8000	 S-M-L
 Ground Fiftyone Race 760 mm Rise 20 mm Dia. 35 mm	 SRAM Guide RE 200/180 mm Disc	 Shimano DU-E8000	
 SRAM EX1 8-S	 Maxxis Ardent 3C MaxxTerra Exo 29x2.35 // Maxxis Rekon 3C MaxxTerra Exo 27.5x2.8	 Shimano BT-E8010 504 Wh	
 DT Swiss H 1900 Spline 30mm Wheelset 15x110 mm // DDT Swiss H 1900 Spline 30mm Wheelset 12x148 mm		 Shimano EC-E6000	

SIZE	ARTICLENUMBER	NOTES
SIZE S	18YC1013	
SIZE M	18YC1014	
SIZE L	18YC1015	



FLAT // titanium gray / star white / riot red

LECTOR S4.7+



MODEL HIGHLIGHTS

- ▶ Lightweight, stiff suspension fork
- ▶ High-end Maxxis tire choice for added grip and safety
- ▶ Equipped with dropper post

MODELL HIGHLIGHTS

- ▶ Leichte und steife Federgabel
- ▶ Hochwertige Maxxis Bereifung für Leichtlauf und Grip
- ▶ Versenkbare Variostütze

Hybride LECTOR LC	Shimano SLX SL-M7000	Formula DC-711 15x110 mm	Shimano BT-E8010 504 Wh
SR Suntour Raidon 34 LOR DS Air 120 mm	Ground Fiftyone 34T	Formula EHL-148A 12x148 mm	Shimano EC-E6000
Ground Fiftyone Team Dia. 35 mm	Sunrace MS8-E 11-46	JD Dropper Post 31.6 mm	16012
Ground Fiftyone Race 760 mm Rise 20 mm Dia. 35 mm	Tektro HD-M805 Slate 4K 4/4 Piston 203/180 mm Disc	Fizik Antares R7	FRH60022
Shimano XT RD-M8000 Shadow Plus 11-S	Maxxis Ardent 3C MaxxTerra Exo 29x2.35 // Maxxis Rekon 3C MaxxTerra Exo 27.5x2.8	Shimano SC-E8000	S-M-L
-	Rodi Tryp 622x30mm 32H // Rodi Tryp 584x30mm 32H	Shimano DU-E8000	

SIZE	ARTICLENUMBER	NOTES
SIZE S	18YC1007	
SIZE M	18YC1008	
SIZE L	18YC1009	



BEAUTIFULLY DESIGNED NEW FRAME WITH INTEGRATED BATTERY // NEUER RAHMEN MIT INTEGRIERTERBATTERIE FÜR EINE FORMSCHÖNE OPTIK

E-BIKE SPECIFIC COMPONENTS // E-BIKE-SPEZIFISCHE KOMponentEN

27.5" AND 29" OPTIONS // 27.5"-UND 29"-OPTIONEN

POWERFUL 4-PISTON BRAKE SYSTEM // KRAFTVOLLE 4 KÖLBEN-BREMSANLAGEN

SHIMANO STEPS 8000 // SHIMANO STEPS 8000

// ALL MOUNTAIN / ALLROUND

FEATURES



CHARACTERISTICS

- ▶ Aluminum frame with integrated powerful 504 Wh battery and Shimano Steps 8000 motor with up to 70 Nm torque at less than 2.9 kg
- ▶ The plush AMR four-bar-linkage chassis guarantees the successful split between efficiency and gulping suspension performance
- ▶ Tour-specific equipment options
- ▶ The compact cockpit guarantees a pleasantly upright seating position

CHARAKTERISTIK

- ▶ Alu-Rahmen mit integriertem 504 Wh Akku und Shimano Steps 8000 Motor mit max. 70 Nm Drehmoment bei unter 2,9 kg
- ▶ Dem satten AMR-Viergelenkfahrwerk gelingt der Spagat zwischen Effizienz und Schluckfreudigkeit
- ▶ Tourenspezifische Ausstattungsvarianten
- ▶ Das kompakte Cockpit bietet eine angenehm aufrechte Sitzposition

TARGET GROUP

- ▶ For fun seeking e-bikers who are on the hunt for an extremely versatile mountainbike

ZIELGRUPPE

- ▶ Für Fahrspaßorientierte E-Biker, die ein enorm leistungsfähiges Mountainbike suchen

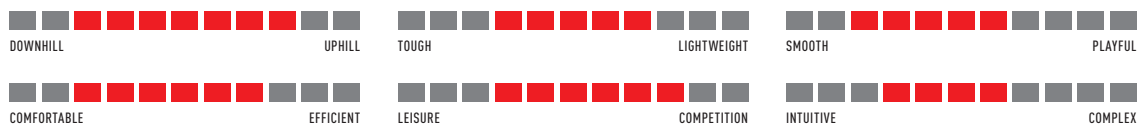

// GEOMETRY AND DATA CHARTS / GEOMETRIE UND TECHNISCHE DATEN

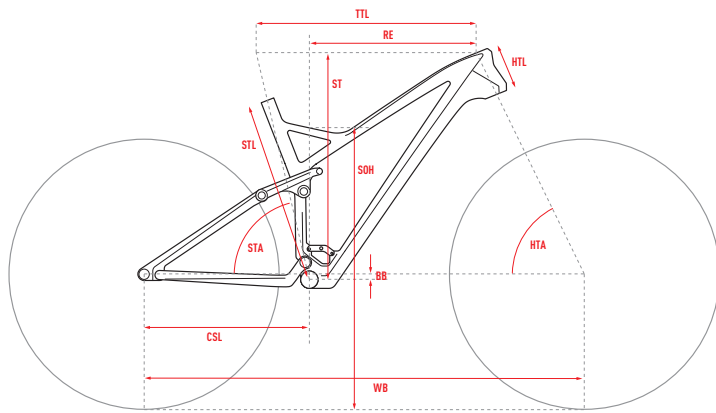

ALL DIMENSIONS IN MM (EXCEPT HTA AND STA IN °)

ALLE MASSE IN MM (AUSNAHME HTA UND STA IN °)

- STL** SEAT TUBE LENGTH
SITZROHRLÄNGE
- CSL** CHAINSTAY LENGTH
KETTENSTREBENLÄNGE
- TTL** TOP TUBE LENGTH
OBERROHRLÄNGE
- HTL** HEADTUBE LENGTH
STEUERROHRLÄNGE
- HTA** HEADTUBE ANGLE
STEUERROHRWINKEL
- STA** SEATTUBE ANGLE
SITZROHRWINKEL
- BB** BB DROP
TRETLAGERABSSENKUNG
- WB** WHEELBASE
RADSTAND
- ST** STACK
STACK
- RE** REACH
REACH
- SOH** STANDOVER HEIGHT
ÜBERSTANDSHÖHE
- HD** HEAD SET DIAMETER (UPPER / LOWER)
STEUERSATZDURCHMESSER (OBEN / UNTEN)
- AS** AXLE STANDARD (REAR / FRONT)
ACHSENSTANDARD (HINTEN / VORNE)
- BS** BOTTOM BRACKET STANDARD
TRETLAGERSTANDARD
- SD** SEAT POST DIAMETER
SITZSTÜTZENDURCHMESSER
- SH** SHOCK HARDWARE (Ø 8MM)
DÄMPFERBUCHSENMASSE (Ø 8MM)
- SL** SHOCK LENGTH
DÄMPFEREINBAULÄNGE
- STV** SHOCK TRAVEL
DÄMPFERHUB
- FV** FRONT FORK TRAVEL
FEDERWEG VORNE
- RV** REAR WHEEL TRAVEL
FEDERWEG HINTEN
- MSH** MIN SADDLE HEIGHT
MIN SÄTTELHÖHE
- MASH** MAX SADDLE HEIGHT
MAX SÄTTELHÖHE
- MSL** MIN INSEAM
MIN SCHRITTLÄNGE
- MASL** MAX INSEAM
MAX SCHRITTLÄNGE
- SLV** STEM LENGTH
VORBAULÄNGE
- HLW** HANDLEBAR WIDTH
LENKERBREITE
- CL** CRANK LENGTH
KURBELLENGE
- SM** SEATTUBE BOTTLE MOUNT
FLASCHE SÄTTELROHR
- DM** DOWNTUBE BOTTLE MOUNT
FLASCHE UNTERROHR

STL CSL TTL HTL HTA STA BB WB ST RE SOH

HYBRIDE KATO FS S8.7+ / S6.7+ / S4.7+ AL U

	S	M	L	XL
STL	390	430	460	500
CSL	455	455	455	455
TTL	573	597	622	647
HTL	100	120	140	160
HTA	66	66	66	66
STA	75.5	75.5	75.5	75.5
BB	20	20	20	20
WB	1185	1212	1241	1269
ST	590	609	627	645
RE	420	440	460	480
SOH	744	758	776	794
HD	ZS44/ZS56	ZS44/ZS56	ZS44/ZS56	ZS44/ZS56
AS	148/110	148/110	148/110	148/110
HD	/	/	/	/
SH	31.6	31.6	31.6	31.6
SL	30/30	30/30	30/30	30/30
STV	210	210	210	210
FV	55	55	55	55
RV	140	140	140	140
MSH	55	55	55	55
MASH	760	760	760	760
MSL	170	170	170	170
MASL	/	/	/	/
SLV	0.5	0.5	0.5	0.5

HYBRIDE KATO FS S4.9 / 3.9 AL U

	S	M	L	XL
STL	390	430	460	500
CSL	455	455	455	455
TTL	569	592	616	640
HTL	100	120	140	160
HTA	67	67	67	67
STA	76.5	76.5	76.5	76.5
BB	28	28	28	28
WB	1176	1203	1232	1260
ST	583	601	619	637
RE	430	440	470	490
SOH	745	759	777	795
HD	ZS44/ZS56	ZS44/ZS56	ZS44/ZS56	ZS44/ZS56
AS	148/110	148/110	148/110	148/110
HD	/	/	/	/
SH	31.6	31.6	31.6	31.6
SL	30/30	30/30	30/30	30/30
STV	210	210	210	210
FV	50	50	50	50
RV	120	120	120	120
MSH	55	55	55	55
MASH	760	760	760	760
MSL	170	170	170	170
MASL	/	/	/	/
SLV	0.5	0.5	0.5	0.5



MODEL HIGHLIGHTS

- ▶ Shimano XT Di2 drivetrain
- ▶ Magura MT 7 4/4-piston brakes
- ▶ Color option available

MODELL HIGHLIGHTS

- ▶ Shimano XT Di2-Antrieb
- ▶ Magura MT 7 4/4-Kolbenbremsen
- ▶ Mit Farboption

Hybride KATO FS AL	-	DT Swiss H 1700 Spline 35 mm Wheelset 15x110 mm // DT Swiss H 1700 Spline 35 mm Wheelset 12x148 mm	Shimano EC-E6000
Rock Shox Pike RC Debon Air 140 mm	Shimano XT Di2 SW-M8050	Kind Shock LEV Integra 31.6 mm	16012
Rock Shox Deluxe RT3 Air 140 mm	Shimano FC-E8050 34T	Ergon SME3D	FRH60058
GHOST MTB Dia. 35 mm	Shimano SLX CS-M7000 11-46	Shimano SC-E8000	S-M-L-XL
GHOST Low Rizer MTB 760 mm Rise 15 mm Dia. 35 mm	Magura MT7 4/4 Piston 203 mm Disc	Shimano DU-E8000	
Shimano XT Di2 RD-M8050 Shadow Plus 11-S	Maxxis Minion DHF 3C MaxxTerra Exo 27.5x2.6 // Maxxis Minion DHR II 3C MaxxTerra Exo 27.5x2.8	Shimano BT-E8010 504 Wh	

SIZE	ARTICLENUMBER	NOTES
SIZE S	18YK3031	
SIZE M	18YK3032	
SIZE L	18YK3033	
SIZE XL	18YK3034	



MODEL HIGHLIGHTS

- ▶ Shimano XT Di2 drivetrain
- ▶ Magura MT 7 4/4-piston brakes
- ▶ Color option available

MODELL HIGHLIGHTS

- ▶ Shimano XT Di2-Antrieb
- ▶ Magura MT 7 4/4-Kolbenbremsen
- ▶ Mit Farboption

Hybride KATO FS AL	-	DT Swiss H 1700 Spline 35 mm Wheelset 15x110 mm // DT Swiss H 1700 Spline 35 mm Wheelset 12x148 mm	Shimano EC-E6000
Rock Shox Pike RC Debon Air 140 mm	Shimano XT Di2 SW-M8050	Kind Shock LEV Integra 31.6 mm	16012
Rock Shox Deluxe RT3 Air 140 mm	Shimano FC-E8050 34T	Ergon SME30	FRHG0058
GHOST MTB Dia. 35 mm	Shimano SLX CS-M7000 11-46	Shimano SC-E8000	S-M-L-XL
GHOST Low Rizer MTB 760 mm Rise 15 mm Dia. 35 mm	Magura MT 7 4/4 Piston 203 mm Disc	Shimano DU-E8000	
Shimano XT Di2 RD-M8050 Shadow Plus 11-S	Maxxis Minion DHF 3C MaxxTerra Exo 27.5x2.6 // Maxxis Minion DHR II 3C MaxxTerra Exo 27.5x2.8	Shimano BT-E8010 504 Wh	

SIZE	ARTICLENUMBER	NOTES
SIZE S	18YK3025	
SIZE M	18YK3026	
SIZE L	18YK3027	
SIZE XL	18YK3028	























MODEL HIGHLIGHTS

- ▶ Equipped with Rock Shox air suspension
- ▶ DT Swiss H 1900 E-bike specific wheelset
- ▶ Color option available

MODELL HIGHLIGHTS

- ▶ Hochwertiges Rock Shox Luftfahrwerk
- ▶ DT Swiss H 1900 E-Bike-Laufräder
- ▶ Mit Farboption

 Hybride KATO FS AL	 -	 DT Swiss H 1900 Spline 35 mm Wheelset 15x110 mm // DT Swiss H 1900 Spline 35 mm Wheelset 12x148 mm	 Shimano EC-E6000
 Rock Shox YARI RC Debon Air 140 mm	 Shimano SLX SL-M7000	 JD Dropper Post 31.6 mm	 16012
 Rock Shox Deluxe RT Air 140 mm	 Shimano FC-E8000 34T	 Selle Italia X-Base	 FRH60058
 GHOST MTB Dia. 35 mm	 Shimano SLX CS-M7000 11-46	 Shimano DU-E8000	 S-M-L-XL
 GHOST Low Rizer MTB 760 mm Rise 15 mm Dia. 35 mm	 Magura MT 5 4/4 Piston 203 mm Disc	 Shimano BT-E8010 504 Wh	
 Shimano XT RD-M8000 Shadow Plus 11-S	 Maxxis Minion DHF 3C MaxxTerra Exo 27.5x2.6 // Maxxis Minion DHR II 3C MaxxTerra Exo 27.5x2.8		

SIZE	ARTICLENUMBER	NOTES
SIZE S	18YK3013	
SIZE M	18YK3014	
SIZE L	18YK3015	
SIZE XL	18YK3016	



MODEL HIGHLIGHTS

- ▶ Equipped with Rock Shox air suspension
- ▶ DT Swiss H 1900 E-bike specific wheelset
- ▶ Color option available

MODELL HIGHLIGHTS

- ▶ Hochwertiges Rock Shox Luftfahrwerk
- ▶ DT Swiss H 1900 E-Bike-Laufräder
- ▶ Mit Farboption

Hybride KATO FS AL	-	DT Swiss H 1900 Spline 35 mm Wheelset 15x110 mm // DT Swiss H 1900 Spline 35 mm Wheelset 12x148 mm	Shimano EC-E6000
Rock Shox YARI RC Debon Air 140 mm	Shimano SLX SL-M7000	JD Dropper Post 31.6 mm	16012
Rock Shox Deluxe RT Air 140 mm	Shimano FC-E8000 34T	Selle Italia X-Base	FRHG0058
GHOST MTB Dia. 35 mm	Shimano SLX CS-M7000 11-46	Shimano SC-E8000	S-M-L-XL
GHOST Low Rizer MTB 760 mm Rise 15 mm Dia. 35 mm	Magura MT 5 4/4 Piston 203 mm Disc	Shimano DU-E8000	
Shimano XT RD-M8000 Shadow Plus 11-S	Maxxis Minion DHF 3C MaxxTerra Exo 27.5x2.6 // Maxxis Minion DHR II 3C MaxxTerra Exo 27.5x2.8	Shimano BT-E8010 504 Wh	

SIZE	ARTICLENUMBER	NOTES
SIZE S	18YK3019	
SIZE M	18YK3020	
SIZE L	18YK3021	
SIZE XL	18YK3022	



MODEL HIGHLIGHTS

- ▶ Equipped with dropper post
- ▶ Wheelset with self-securing nipples
- ▶ Color option available

MODELL HIGHLIGHTS

- ▶ Versenkbare Variostütze
- ▶ Laufräder mit selbstsichernden Nippeln
- ▶ Mit Farboption

Hybride KATO FS AL	-	Rodi Tryp 584x35 mm 32H // Rodi Tryp 584x35 mm 32H	Shimano DU-E8000
SR Suntour AION 35 RC DS 140 mm	Shimano SLX SL-M7000	Formula DC-511 15x110 mm	Shimano BT-E8010 504 Wh
Rock Shox Deluxe RT Air 140 mm	Shimano FC-E8000 34T	Formula EHL-148A 12x148 mm	Shimano EC-E6000
GHOST MTB Dia. 35 mm	Shimano SLX CS-M7000 11-46	JD Dropper Post 31.6 mm	16012
GHOST Low Rizer MTB 760 mm Rise 15 mm Dia. 35 mm	Tektro HD-M805 Slate 4K 4/4 Piston 203 mm Disc	Selle Italia X-Base	FRHG0058
Shimano XT RD-M8000 Shadow Plus 11-S	Maxxis Minion DHF 3C MaxxTerra Exo 27.5x2.6 // Maxxis Minion DHR II 3C MaxxTerra Exo 27.5x2.8	Shimano SC-E8000	S-M-L-XL

SIZE	ARTICLENUMBER	NOTES
SIZE S	18YK3001	
SIZE M	18YK3002	
SIZE L	18YK3003	
SIZE XL	18YK3004	



MODEL HIGHLIGHTS

- ▶ Equipped with dropper post
- ▶ Wheelset with self-securing nipples
- ▶ Color option available

MODELL HIGHLIGHTS

- ▶ Versenkbare Variostütze
- ▶ Laufräder mit selbstsichernden Nippeln
- ▶ Mit Farboption

Hybride KATO FS AL	-	Rodi Tryp 584x35 mm 32H // Rodi Tryp 584x35 mm 32H	Shimano DU-E8000
SR Suntour AION 35 RC DS 140 mm	Shimano SLX SL-M7000	Formula DC-511 15x110 mm	Shimano BT-E8010 504 Wh
Rock Shox Deluxe RT Air 140 mm	Shimano FC-E8000 34T	Formula EHL-148A 12x148 mm	Shimano EC-E6000
GHOST MTB Dia. 35 mm	Shimano SLX CS-M7000 11-46	JD Dropper Post 31.6 mm	16012
GHOST Low Rizer MTB 760 mm Rise 15 mm Dia. 35 mm	Tektro HD-M805 Slate 4K 4/4 Piston 203 mm Disc	Selle Italia X-Base	FRHG0058
Shimano XT RD-M8000 Shadow Plus 11-S	Maxxis Minion DHF 3C MaxxTerra Exo 27.5x2.6 // Maxxis Minion DHR II 3C MaxxTerra Exo 27.5x2.8	Shimano SC-E8000	S-M-L-XL

SIZE	ARTICLENUMBER	NOTES
SIZE S	18YK3007	
SIZE M	18YK3008	
SIZE L	18YK3009	
SIZE XL	18YK3010	



MODEL HIGHLIGHTS

- ▶ Equipped with dropper post
- ▶ E-bike specific components
- ▶ Different color and wheel size option available

MODELL HIGHLIGHTS

- ▶ Versenkbare Variostütze
- ▶ E-Bike-spezifische Anbauteile
- ▶ Mit Farb- und Laufradoption

Hybride KATO FS AL	-	Rodi Tryp 622x25 mm 32H // Rodi Tryp 622x25 mm 32H	Shimano DU-E8000
SR Suntour AION 35 RC DS 120 mm	Shimano SLX SL-M7000	Formula DC-511 15x110 mm	Shimano BT-E8010 504 Wh
Rock Shox Deluxe RT Air 130 mm	Shimano FC-E8000 34T	Formula EHL-148A 12x148 mm	Shimano EC-E6000
GHOST MTB Dia. 35 mm	Shimano SLX CS-M7000 11-46	JD Dropper Post 31.6 mm	16012
GHOST Low Rizer MTB 760 mm Rise 15 mm Dia. 35 mm	Tektro HD-M805 Slate 4K 4/4 Piston 203 mm Disc	Selle Italia X-Base	FRHG0058
Shimano XT RD-M8000 Shadow Plus 11-S	Schwalbe Nobby Nic Performance Addix 29x2.25 // Schwalbe Nobby Nic Performance Addix 29x2.25	Shimano SC-E8000	S-M-L-XL

SIZE	ARTICLENUMBER	NOTES
SIZE S	18YK4013	
SIZE M	18YK4014	
SIZE L	18YK4015	
SIZE XL	18YK4016	



MODEL HIGHLIGHTS

- ▶ Equipped with dropper post
- ▶ E-bike specific components
- ▶ Different color and wheel size option available

MODELL HIGHLIGHTS

- ▶ Versenkbare Variostütze
- ▶ E-Bike-spezifische Anbauteile
- ▶ Mit Farb- und Laufradoption

Hybride KATO FS AL	-	Rodi Tryp 622x25 mm 32H // Rodi Tryp 622x25 mm 32H	Shimano DU-E8000
SR Suntour AION 35 RC DS 120 mm	Shimano SLX SL-M7000	Formula DC-511 15x110 mm	Shimano BT-E8010 504 Wh
Rock Shox Deluxe RT Air 130 mm	Shimano FC-E8000 34T	Formula EHL-148A 12x148 mm	Shimano EC-E6000
GHOST MTB Dia. 35 mm	Shimano SLX CS-M7000 11-46	JD Dropper Post 31.6 mm	16012
GHOST Low Rizer MTB 760 mm Rise 15 mm Dia. 35 mm	Tektro HD-M805 Slate 4K 4/4 Piston 203 mm Disc	Selle Italia X-Base	FRHG0058
Shimano XT RD-M8000 Shadow Plus 11-S	Schwalbe Nobby Nic Performance Addix 29x2.25 // Schwalbe Nobby Nic Performance Addix 29x2.25	Shimano SC-E8000	S-M-L-XL

SIZE	ARTICLENUMBER	NOTES
SIZE S	18YK4019	
SIZE M	18YK4020	
SIZE L	18YK4021	
SIZE XL	18YK4022	



FLAT // night black / vibrant blue

KATO FS S3.9



MODEL HIGHLIGHTS

- ▶ Comfortable, fast rolling tourer
- ▶ Reliable components
- ▶ Color option available

MODELL HIGHLIGHTS

- ▶ Komfortabler, schneller Tourer
- ▶ Zuverlässige Ausstattung
- ▶ Mit Farboption

Hybride KATO FS AL	-	Rodi Tryp 622x25 mm 32H // Rodi Tryp 622x25 mm 32H	Shimano DU-E8000
SR Suntour XCR 34 LOR AIR 120 mm	Shimano Deore SL-M6000	Formula DC-511 15x110 mm	Shimano BT-E8010 504 Wh
XFusion O2 Pro RL Air 130 mm	Shimano FC-E8000 34T	Formula EHL-148S 12x148 mm	Shimano EC-E6000
GHOST MTB Dia. 35 mm	Shimano CS-HG500-10 11-42	GHOST Light DC 1 31.6 mm	16012
GHOST Low Rizer MTB 760 mm Rise 15 mm Dia. 35 mm	Magura MT Thirty2 4/2 Piston 203 mm Disc	Selle Italia X-Base	FRHG0058
Shimano Deore RD-M6000 Shadow Plus 10-S	Schwalbe Nobby Nic Performance Addix 29x2.25 // Schwalbe Nobby Nic Performance Addix 29x2.25	Shimano SC-E8000	S-M-L-XL

SIZE	ARTICLENUMBER	NOTES
SIZE S	18YK4001	
SIZE M	18YK4002	
SIZE L	18YK4003	
SIZE XL	18YK4004	



MODEL HIGHLIGHTS

- ▶ Comfortable, fast rolling tourer
- ▶ Reliable components
- ▶ Color option available

MODELL HIGHLIGHTS

- ▶ Komfortabler, schneller Tourer
- ▶ Zuverlässige Ausstattung
- ▶ Mit Farboption

Hybride KATO FS AL	-	Rodi Tryp 622x25 mm 32H // Rodi Tryp 622x25 mm 32H	Shimano DU-E8000
SR Suntour XCR 34 LOR AIR 120 mm	Shimano Deore SL-M6000	Formula DC-511 15x110 mm	Shimano BT-E8010 504 Wh
XFusion 02 Pro RL Air 130 mm	Shimano FC-E8000 34T	Formula EHL-148S 12x148 mm	Shimano EC-E6000
GHOST MTB Dia. 35 mm	Shimano CS-HG500-10 11-42	GHOST Light DC 1 31.6 mm	16012
GHOST Low Rizer MTB 760 mm Rise 15 mm Dia. 35 mm	Magura MT Thirty2 4/2 Piston 203 mm Disc	Selle Italia X-Base	FRHG0058
Shimano Deore RD-M6000 Shadow Plus 10-S	Schwalbe Nobby Nic Performance Addix 29x2.25 // Schwalbe Nobby Nic Performance Addix 29x2.25	Shimano SC-E8000	S-M-L-XL

SIZE	ARTICLENUMBER	NOTES
SIZE S	18YK4007	
SIZE M	18YK4008	
SIZE L	18YK4009	
SIZE XL	18YK4010	



// ALLROUND / TRAIL

FEATURES



CHARACTERISTICS

- ▶ Aluminum frame with integrated powerful 504 Wh battery and Shimano Steps 8000 motor with up to 70 Nm torque at less than 2.9 kg
- ▶ The new geometry leads to an exceptionally versatile hardtail
- ▶ The latest standards like front and back thru-axles create an especially efficient unit

CHARAKTERISTIK

- ▶ Alu-Rahmen mit integriertem 504 Wh Akku und Shimano Steps 8000 Motor mit max. 70 Nm Drehmoment bei unter 2,9 kg
- ▶ Die neue Geometrie resultiert in einem unvergleichbar vielseitigen Hardtail
- ▶ Modernen Standards wie Steckachsen vorn und hinten ergeben eine besonders effiziente Einheit

TARGET GROUP

- ▶ Mountainbiker looking to have fun on an e-bike

ZIELGRUPPE

- ▶ E-Mountainbiker, bei denen Fahrspaß an erster Stelle steht





// GEOMETRY AND DATA CHARTS / GEOMETRIE UND TECHNISCHE DATEN

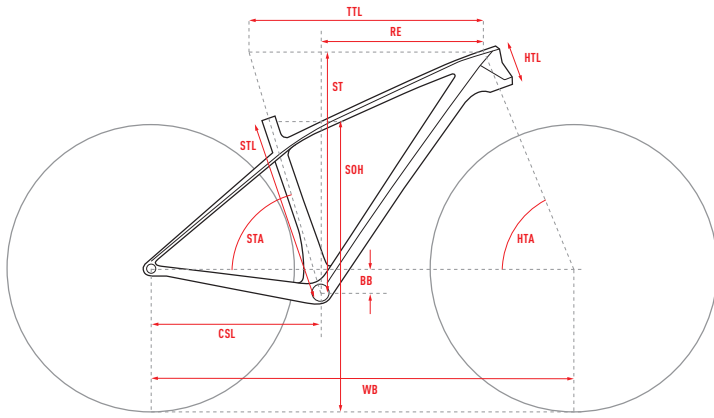

ALL DIMENSIONS IN MM (EXCEPT HTA AND STA IN °)

ALLE MASSE IN MM (AUSNAHME HTA UND STA IN °)

- STL** SEAT TUBE LENGTH
SITZROHRLÄNGE
- CSL** CHAINSTAY LENGTH
KETTENSTREBENLÄNGE
- TTL** TOP TUBE LENGTH
OBERROHRLÄNGE
- HTL** HEADTUBE LENGTH
STEUERROHRLÄNGE
- HTA** HEADTUBE ANGLE
STEUERROHRWINKEL
- STA** SEATTUBE ANGLE
SITZROHRWINKEL
- BB** BB DROP
TRETLAGERABSSENKUNG
- WB** WHEELBASE
RADSTAND
- ST** STACK
STACK
- RE** REACH
REACH
- SOH** STANDOVER HEIGHT
ÜBERSTANDSHÖHE
- HEAD SET DIAMETER (UPPER / LOWER)
STEUERSATZDURCHMESSER (OBEN / UNTEN)
- AXLE STANDARD (REAR / FRONT)
ACHSENSTANDARD (HINTEN / VORNE)
- BOTTOM BRACKET STANDARD
TRETLAGERSTANDARD
- SEAT POST DIAMETER
SITZELSTÜTZENDURCHMESSER
- SHOCK HARDWARE (Ø 8MM)
DÄMPFERBUCHSENMASSE (Ø 8MM)
- SHOCK LENGTH
DÄMPFEREINBAULÄNGE
- SHOCK TRAVEL
DÄMPFERHUB
- FRONT FORK TRAVEL
FEDERWEG VORNE
- REAR WHEEL TRAVEL
FEDERWEG HINTEN
- MIN SADDLE HEIGHT
MIN SATTELHÖHE
- MAX SADDLE HEIGHT
MAX SATTELHÖHE
- MIN INSEAM
MIN SCHRITTLÄNGE
- MAX INSEAM
MAX SCHRITTLÄNGE
- STEM LENGTH
VORBAULÄNGE
- HANDLEBAR WIDTH
LENKERBREITE
- CRANK LENGTH
KURBELLÄNGE
- SEAT TUBE BOTTLE MOUNT
FLASCHE SATTELROHR
- DOWNTUBE BOTTLE MOUNT
FLASCHE UNTERROHR

STL CSL TTL HTL HTA STA BB WB ST RE SOH ST DT

HYBRIDE KATO S8.7+ / S6.7+ / S4.7+ / 3.7+ AL U

	S	M	L	XL
STL	380	420	460	500
CSL	442.5	442.5	442.5	442.5
TTL	599	615	634	653
HTL	100	105	120	135
HTA	66	66	66	66
STA	73.5	73.5	73.5	73.5
BB	56	56	56	56
WB	1165	1181	1203	1224
ST	620	625	638	652
RE	415	430	445	460
SOH	689	709	728	762
Headset	ZS44/ZS56	ZS44/ZS56	ZS44/ZS56	ZS44/ZS56
Axle	148/110	148/110	148/110	148/110
Bracket	/	/	/	/
Seat post	31.6	31.6	31.6	31.6
Shock hardware	/	/	/	/
Shock length	/	/	/	/
Shock travel	/	/	/	/
Front fork travel	130	130	130	130
Rear wheel travel	/	/	/	/
Min saddle height	55	55	55	55
Max saddle height	760	760	760	760
Min inseam	170	170	170	170
Max inseam	/	0.5	0.5	0.5

HYBRIDE KATO S4.9 AL U

	S	M	L	XL
STL	380	420	460	500
CSL	442.5	442.5	442.5	442.5
TTL	597	612	631	649
HTL	100	105	120	135
HTA	66.5	66.5	66.5	66.5
STA	74	74	74	74
BB	60	60	60	60
WB	1161	1177	1199	1220
ST	616	621	634	648
RE	410	425	440	455
SOH	695	715	734	768
Headset	ZS44/ZS56	ZS44/ZS56	ZS44/ZS56	ZS44/ZS56
Axle	148/110	148/110	148/110	148/110
Bracket	/	/	/	/
Seat post	31.6	31.6	31.6	31.6
Shock hardware	/	/	/	/
Shock length	/	/	/	/
Shock travel	/	/	/	/
Front fork travel	120	120	120	120
Rear wheel travel	/	/	/	/
Min saddle height	55	55	55	55
Max saddle height	760	760	760	760
Min inseam	170	170	170	170
Max inseam	/	0.5	0.5	0.5

HYBRIDE KATO S3.9 AL U

	S	M	L	XL
STL	380	420	460	500
CSL	442.5	442.5	442.5	442.5
TTL	599	615	634	653
HTL	100	105	120	135
HTA	66	66	66	66
STA	73.5	73.5	73.5	73.5
BB	56	56	56	56
WB	1165	1181	1203	1224
ST	620	625	638	652
RE	415	430	445	460
SOH	699	719	738	772
Headset	ZS44/ZS56	ZS44/ZS56	ZS44/ZS56	ZS44/ZS56
Axle	148/110	148/110	148/110	148/110
Bracket	/	/	/	/
Seat post	31.6	31.6	31.6	31.6
Shock hardware	/	/	/	/
Shock length	/	/	/	/
Shock travel	/	/	/	/
Front fork travel	130	130	130	130
Rear wheel travel	/	/	/	/
Min saddle height	55	55	55	55
Max saddle height	760	760	760	760
Min inseam	170	170	170	170
Max inseam	/	0.5	0.5	0.5



FLAT // night black / night black / neon red

KATO S8.7+



MODEL HIGHLIGHTS

- ▶ High-end components
- ▶ Magura MT 7 4/4-piston discbrakes
- ▶ DT Swiss H 1700 Spline E-bike specific wheelset

MODELL HIGHLIGHTS

- ▶ Hochwertige Ausstattung
- ▶ Magura MT 7 4/4-Kolbenbremsen
- ▶ DT Swiss H 1700 Spline E-Bike-Laufräder

Hybride KATO AL	Shimano XT DIZ SW-M8050	Kind Shock LEV Integra 31,6 mm	16012
Fox 36 Float Performance Elite 130 mm	Shimano FC-E8050 34T	Ergon SME30	FRH60022
Ground Fiftyone Team Dia. 35 mm	Shimano SLX CS-M7000 11-46	Shimano SC-E8000	S-M-L-XL
Ground Fiftyone Race 760 mm Rise 20 mm Dia. 35 mm	Magura MT7 4/4 Piston 203 mm Disc	Shimano DU-E8000	
Shimano XT DIZ RD-M8050 Shadow Plus 11-S	Maxxis Minion DHF 3C MaxxTerra Exo 27.5x2.6 // Maxxis Minion DHR II 3C MaxxTerra Exo 27.5x2.8	Shimano BT-E8010 504 Wh	
-	DT Swiss H 1700 Spline 35 mm Wheelset 15x110 mm // DT Swiss H 1700 Spline 35 mm Wheelset 12x148 mm	Shimano EC-E6000	

SIZE	ARTICLENUMBER	NOTES
SIZE S	18YK1037	
SIZE M	18YK1038	
SIZE L	18YK1039	
SIZE XL	18YK1040	



MODEL HIGHLIGHTS

- ▶ High-end components
- ▶ Magura MT 7 4/4-piston discbrakes
- ▶ DT Swiss H 1700 Spline E-bike specific wheelset

MODELL HIGHLIGHTS

- ▶ Hochwertige Ausstattung
- ▶ Magura MT 7 4/4-Kolbenbremsen
- ▶ DT Swiss H 1700 Spline E-Bike-Laufräder

Hybride KATO AL	Shimano XT D12 SW-M8050	Kind Shock LEV Integra 31.6 mm	16012
Fox 36 Float Performance Elite 130 mm	Shimano FC-E8050 34T	Ergon SME30	FRHG0022
Ground Fiftyone Team Dia. 35 mm	Shimano SLX CS-M7000 11-46	Shimano SC-E8000	S-M-L-XL
Ground Fiftyone Race 760 mm Rise 20 mm Dia. 35 mm	Magura MT7 4/4 Piston 203 mm Disc	Shimano DU-E8000	
Shimano XT D12 RD-M8050 Shadow Plus 11-S	Maxxis Minion DHF 3C MaxxTerra Exo 27.5x2.6 // Maxxis Minion DHR II 3C MaxxTerra Exo 27.5x2.8	Shimano BT-E8010 504 Wh	
-	DT Swiss H 1700 Spline 35 mm Wheelset 15x110 mm // DT Swiss H 1700 Spline 35 mm Wheelset 12x148 mm	Shimano EC-E6000	

SIZE	ARTICLENUMBER	NOTES
SIZE S	18YK1043	
SIZE M	18YK1044	
SIZE L	18YK1045	
SIZE XL	18YK1046	



MODEL HIGHLIGHTS

- ▶ Magura MT 5 4/4-piston brakes
- ▶ High-end Maxxis tire choice for added grip and safety
- ▶ DT Swiss H 1900 E-bike specific wheelset

MODELL HIGHLIGHTS

- ▶ Magura MT 5 4/4-Kolbenbremsen
- ▶ Hochwertige Maxxis Bereifung für Grip und Sicherheit
- ▶ DT Swiss H 1900 E-Bike-Laufräder

Hybride KATO AL	Shimano XT SL-M8000	JD Dropper Post 31,6 mm	16012
Rock Shox YARI RC Debon Air 130 mm	Shimano FC-E8000 34T	Selle Italia X-Base	FRH60022
GHOST MTB Dia. 35 mm	Shimano SLX CS-M7000 11-46	Shimano SC-E8000	S-M-L-XL
GHOST Low Rizer MTB 760 mm Rise 15 mm Dia. 35 mm	Magura MT 5 4/4 Piston 203 mm Disc	Shimano DU-E8000	
Shimano XT RD-M8000 Shadow Plus 11-S	Maxxis Minion DHF 3C MaxxTerra Exo 27.5x2.6 // Maxxis Minion DHR II 3C MaxxTerra Exo 27.5x2.8	Shimano BT-E8010 504 Wh	
DT Swiss H 1900 Spline 35 mm Wheelset 15x110 mm // DT Swiss H 1900 Spline 35 mm Wheelset 12x148 mm		Shimano EC-E6000	

SIZE	ARTICLENUMBER	NOTES
SIZE S	18YK1031	
SIZE M	18YK1032	
SIZE L	18YK1033	
SIZE XL	18YK1034	























MODEL HIGHLIGHTS

- ▶ Magura MT 5 4/4-piston brakes
- ▶ High-end Maxxis tire choice for added grip and safety
- ▶ DT Swiss H 1900 E-bike specific wheelset

MODELL HIGHLIGHTS

- ▶ Magura MT 5 4/4-Kolbenbremsen
- ▶ Hochwertige Maxxis Bereifung für Grip und Sicherheit
- ▶ DT Swiss H 1900 E-Bike-Laufräder

 Hybride KATO AL	 Shimano XT SL-M8000	 JD Dropper Post 31.6 mm	 16012
 Rock Shox YARI RC Debon Air 130 mm	 Shimano FC-E8000 34T	 Selle Italia X-Base	 FRHG0022
 GHOSH MTB Dia. 35 mm	 Shimano SLX CS-M7000 11-46	 Shimano SC-E8000	 S-M-L-XL
 GHOSH Low Rizer MTB 760 mm Rise 15 mm Dia. 35 mm	 Magura MT 5 4/4 Piston 203 mm Disc	 Shimano DU-E8000	
 Shimano XT RD-M8000 Shadow Plus 11-S	 Maxxis Minion DHF 3C MaxxTerra Exo 27.5x2.6 // Maxxis Minion DHR II 3C MaxxTerra Exo 27.5x2.8	 Shimano BT-E8010 504 Wh	
 DT Swiss H 1900 Spline 35 mm Wheelset 15x110 mm // DT Swiss H 1900 Spline 35 mm Wheelset 12x148 mm		 Shimano EC-E6000	

SIZE	ARTICLENUMBER	NOTES
SIZE S	18YK1025	
SIZE M	18YK1026	
SIZE L	18YK1027	
SIZE XL	18YK1028	



FLAT // night black / urban gray / neon orange

KATO S4.7+



MODEL HIGHLIGHTS

- ▶ Sporty Shimano Steps 8000 motor for highest demands
- ▶ Equipped with dropper post
- ▶ Different color and wheel size option available

MODELL HIGHLIGHTS

- ▶ Sportiver Steps 8000 Antrieb für hohe Ansprüche
- ▶ Mit versenkbarer Variostütze
- ▶ Mit Farb- und Laufradoption

Hybride KATO AL	Shimano SLX SL-M7000	Formula DC-711 15x110 mm	Shimano BT-E8010 504 Wh
SR Suntour Raidon 34 LOR DS AIR 130 mm	Shimano FC-E8000 34T	Formula EHL-148A 12x148 mm	Shimano EC-E6000
GHOST MTB Dia. 35 mm	Shimano SLX CS-M7000 11-46	JD Dropper Post 31.6 mm	16012
GHOST Low Rizer MTB 760 mm Rise 15 mm Dia. 35 mm	Tektro HD-M805 Slate 4K 4/4 Piston 203 mm Disc	Selle Italia X-Base	FRH60022
Shimano XT RD-M8000 Shadow Plus 11-S	Maxxis Minion DHF 3C MaxxTerra Exo 27.5x2.6 // Maxxis Minion DHR II 3C MaxxTerra Exo 27.5x2.8	Shimano SC-E8000	S-M-L-XL
-	Rodi Tryp 584x35 mm 32H // Rodi Tryp 584x35 mm 32H	Shimano DU-E8000	

SIZE	ARTICLENUMBER	NOTES
SIZE S	18YK1013	
SIZE M	18YK1014	
SIZE L	18YK1015	
SIZE XL	18YK1016	

189

























MODEL HIGHLIGHTS

- ▶ Sporty Shimano Steps 8000 motor for highest demands
- ▶ Equipped with dropper post
- ▶ Different color and wheel size option available

MODELL HIGHLIGHTS

- ▶ Sportiver Steps 8000 Antrieb für hohe Ansprüche
- ▶ Mit versenkbarer Variostütze
- ▶ Mit Farb- und Laufradoption

 Hybride KATO AL	 Shimano SLX SL-M7000	 Formula DC-711 15x110 mm	 Shimano BT-E8010 504 WH
 SR Suntour Raidon 34 LOR DS AIR 130 mm	 Shimano FC-E8000 34T	 Formula EHL-148A 12x148 mm	 Shimano EC-E6000
 GHOST MTB Dia. 35 mm	 Shimano SLX CS-M7000 11-46	 JD Dropper Post 31.6 mm	 16012
 GHOST Low Rizer MTB 760 mm Rise 15 mm Dia. 35 mm	 Tektro HD-M805 Slate 4K 4/4 Piston 203 mm Disc	 Selle Italia X-Base	 FRHG0022
 Shimano XT RD-M8000 Shadow Plus 11-S	 Maxxis Minion DHF 3C MaxxTerra Exo 27.5x2.6 // Maxxis Minion DHR II 3C MaxxTerra Exo 27.5x2.8	 Shimano SC-E8000	 S-M-L-XL
 Rodi Tryp 584x35 mm 32H // Rodi Tryp 584x35 mm 32H	 Shimano DU-E8000		

SIZE	ARTICLENUMBER	NOTES
SIZE S	18YK1019	
SIZE M	18YK1020	
SIZE L	18YK1021	
SIZE XL	18YK1022	



FLAT // night black / urban gray / neon orange



MODEL HIGHLIGHTS

- ▶ Sporty Shimano Steps 8000 motor for highest demands
- ▶ Tektro 4-piston brakes
- ▶ Different color and wheel size option available

MODELL HIGHLIGHTS

- ▶ Sportiver Steps 8000 Antrieb für hohe Ansprüche
- ▶ Tektro 4-Kolbenbremsen
- ▶ Mit Farb- und Laufradoption

Hybride KATO AL	Shimano SLX SL-M7000	Formula DC-711 15x110 mm	Shimano BT-E8010 504 Wh
SR Suntour Raidon 34 LOR DS AIR 120 mm	Shimano FC-E8000 38T	Formula EHL-148A 12x148 mm	Shimano EC-E6000
GHOST MTB Dia. 35 mm	Shimano SLX CS-M7000 11-46	JD Dropper Post 31.6 mm	16012
GHOST Low Rizer MTB 760 mm Rise 15 mm Dia. 35 mm	Tektro HD-M805 Slate 4K 4/4 Piston 203 mm Disc	Selle Italia X-Base	FRH60022
Shimano XT RD-M8000 Shadow Plus 11-S	Schwalbe Nobby Nic Performance Addix 29x2.35 // Schwalbe Nobby Nic Performance Addix 29x2.35	Shimano SC-E8000	S-M-L-XL
-	Rodi Tryp 622x25 mm 32H // Rodi Tryp 622x25 mm 32H	Shimano DU-E8000	

SIZE	ARTICLENUMBER	NOTES
SIZE S	18YK2013	
SIZE M	18YK2014	
SIZE L	18YK2015	
SIZE XL	18YK2016	



MODEL HIGHLIGHTS

- ▶ Sporty Shimano Steps 8000 moto for highest demands
- ▶ Tektro 4-piston brakes
- ▶ Different color and wheel size option available

MODELL HIGHLIGHTS

- ▶ Sportiver Steps 8000 Antrieb für hohe Ansprüche
- ▶ Tektro 4-Kolbenbremsen
- ▶ Mit Farb- und Laufradoption

Hybride KATO AL	Shimano SLX SL-M7000	Formula DC-711 15x110 mm	Shimano BT-E8010 504 WH
SR Suntour Raidon 34 LOR DS AIR 120 mm	Shimano FC-E8000 38T	Formula EHL-148A 12x148 mm	Shimano EC-E6000
GHOST MTB Dia. 35 mm	Shimano SLX CS-M7000 11-46	JD Dropper Post 31.6 mm	16012
GHOST Low Rizer MTB 760 mm Rise 15 mm Dia. 35 mm	Tektro HD-M805 Slate 4K 4/4 Piston 203 mm Disc	Selle Italia X-Base	FRHG0022
Shimano XT RD-M8000 Shadow Plus 11-S	Schwalbe Nobby Nic Performance Addix 29x2.35 // Schwalbe Nobby Nic Performance Addix 29x2.35	Shimano SC-E8000	S-M-L-XL
Rodri Tryp 622x25 mm 32H // Rodri Tryp 622x25 mm 32H	Shimano DU-E8000		

SIZE	ARTICLENUMBER	NOTES
SIZE S	18YK2019	
SIZE M	18YK2020	
SIZE L	18YK2021	
SIZE XL	18YK2022	



FLAT // night black / vibrant blue

KATO S3.7+



MODEL HIGHLIGHTS

- ▶ High-end Maxxis tires choice for added grip and safety
- ▶ E-bike specific components
- ▶ Different color and wheel size option available

MODELL HIGHLIGHTS

- ▶ Hochwertige Maxxis Bereifung für Grip und Sicherheit
- ▶ E-Bike-spezifische Anbauteile
- ▶ Mit Farb- und Laufradoption

Hybride KATO AL	Shimano Deore SL-M6000	Formula DC-511 15x110 mm	Shimano BT-E8010 504 Wh
SR Suntour XCR 34 LOR AIR 130 mm	Shimano FC-E8000 34T	Formula EHL-14BS 12x148 mm	Shimano EC-E6000
GHOST MTB Dia. 35 mm	Shimano CS-HG500-10 11-42	GHOST Light DC 1 31.6 mm	16012
GHOST Low Rizer MTB 760 mm Rise 15 mm Dia. 35 mm	Magura MT Thirty2.4/2 Piston 203 mm Disc	Selle Italia X-Base	FRH60022
Shimano Deore RD-M6000 Shadow Plus 10-S	Maxxis Minion DHF 3C MaxxTerra Exo 27.5x2.6 // Maxxis Minion DHR II 3C MaxxTerra Exo 27.5x2.6	Shimano SC-E8000	S-M-L-XL
-	Rodi Tryp 584x35 mm 32H // Rodi Tryp 584x35 mm 32H	Shimano DU-E8000	

SIZE	ARTICLENUMBER	NOTES
SIZE S	18YK1001	
SIZE M	18YK1002	
SIZE L	18YK1003	
SIZE XL	18YK1004	

























MODEL HIGHLIGHTS

- ▶ High-end Maxxis tires choice for added grip and safety
- ▶ E-bike specific components
- ▶ Different color and wheel size option available

MODELL HIGHLIGHTS

- ▶ Hochwertige Maxxis Bereifung für Grip und Sicherheit
- ▶ E-Bike-spezifische Anbauteile
- ▶ Mit Farb- und Laufradoption

 Hybride KATO AL	 Shimano Deore SL-M6000	 Formula DC-511 15x110 mm	 Shimano BT-E8010 504 WH
 SR Suntour XCR 34 LOR AIR 130 mm	 Shimano FC-E8000 34T	 Formula EHL-148S 12x148 mm	 Shimano EC-E6000
 GHOST MTB Dia. 35 mm	 Shimano CS-HG500-10 11-42	 GHOST Light DC 1 31.6 mm	 16012
 GHOST Low Rizer MTB 760 mm Rise 15 mm Dia. 35 mm	 Magura MT Thirty2 4/2 Piston 203 mm Disc	 Selle Italia X-Base	 FRHG0022
 Shimano Deore RD-M6000 Shadow Plus 10-S	 Maxxis Minion DHF 3C MaxxTerra Exo 27.5x2.6 // Maxxis Minion DHR II 3C MaxxTerra Exo 27.5x2.8	 Shimano SC-E8000	 S-M-L-XL
 -	 Rodi Tryp 584x35 mm 32H // Rodi Tryp 584x35 mm 32H	 Shimano DU-E8000	

SIZE	ARTICLENUMBER	NOTES
SIZE S	18YK1007	
SIZE M	18YK1008	
SIZE L	18YK1009	
SIZE XL	18YK1010	



FLAT // night black / vibrant blue

KATO S3.9



MODEL HIGHLIGHTS

- ▶ Sporty Shimano Steps 8000 motor for highest demands
- ▶ Magura MT Thirty2 4/2-piston brake for safe braking power
- ▶ Different color and wheel size option available

MODELL HIGHLIGHTS

- ▶ Sportiver Steps 8000 Antrieb für hohe Ansprüche
- ▶ Magura MT Thirty2 4/2-Kolbenbremse: sicher bremsen
- ▶ Mit Farb- und Laufradoption

Hybride KATO AL	Shimano Deore SL-M6000	Formula DC-511 15x110 mm	Shimano BT-E8010 504 Wh
SR Suntour XCR 34 LOR AIR 120 mm	Shimano FC-E8000 38T	Formula EHL-148S 12x148 mm	Shimano EC-E6000
GHOST MTB Dia. 35 mm	Shimano CS-HG500-10 11-42	GHOST Light DC 1 31.6 mm	16012
GHOST Low Rizer MTB 760 mm Rise 15 mm Dia. 35 mm	Magura MT Thirty2 4/2 Piston 203 mm Disc	Selle Italia X-Base	FRH60022
Shimano Deore RD-M6000 Shadow Plus 10-S	Schwalbe Nobby Nic Performance Addix 29x2.25 // Schwalbe Nobby Nic Performance Addix 29x2.25	Shimano SC-E8000	S-M-L-XL
-	Rodi Tryp 622x25 mm 32H // Rodi Tryp 622x25 mm 32H	Shimano DU-E8000	

SIZE	ARTICLENUMBER	NOTES
SIZE S	18YK2001	
SIZE M	18YK2002	
SIZE L	18YK2003	
SIZE XL	18YK2004	



MODEL HIGHLIGHTS

- ▶ Sporty Shimano Steps 8000 motor for highest demands
- ▶ Magura MT Thirty2 4/2-piston brake for safe stopping power
- ▶ Different color and wheel size option available

MODELL HIGHLIGHTS

- ▶ Sportiver Steps 8000 Antrieb für hohe Ansprüche
- ▶ Magura MT Thirty2 4/2-Kolbenbremse: sicher bremsen
- ▶ Mit Farb- und Laufradoption

Hybride KATO AL	Shimano Deore SL-M6000	Formula DC-511 15x110 mm	Shimano BT-E8010 504 WH
SR Suntour XCR 34 LOR AIR 120 mm	Shimano FC-E8000 38T	Formula EHL-148S 12x148 mm	Shimano EC-E6000
GHOST MTB Dia. 35 mm	Shimano CS-HG500-10 11-42	GHOST Light DC 1 31.6 mm	16012
GHOST Low Rizer MTB 760 mm Rise 15 mm Dia. 35 mm	Magura MT Thirty2 4/2 Piston 203 mm Disc	Selle Italia X-Base	FRHG0022
Shimano Deore RD-M6000 Shadow Plus 10-S	Schwalbe Nobby Nic Performance Addix 29x2.25 // Schwalbe Nobby Nic Performance Addix 29x2.25	Shimano SC-E8000	S-M-L-XL
-	Rodi Tryp 622x25 mm 32H // Rodi Tryp 622x25 mm 32H	Shimano DU-E8000	

SIZE	ARTICLENUMBER	NOTES
SIZE S	18YK2007	
SIZE M	18YK2008	
SIZE L	18YK2009	
SIZE XL	18YK2010	



// ALL MOUNTAIN / ALLROUND

FEATURES



CHARACTERISTICS

- ▶ Aluminum frame with integrated powerful 504 Wh battery and Shimano Steps 8000 motor with up to 70 Nm torque at less than 2.9 kg
- ▶ The plush AMR four-bar-linkage chassis guarantees the successful split between efficiency and gulping suspension performance
- ▶ Custom contact points for women
- ▶ 29" for tour-oriented riders, 27.5"+ for technically skilled, downhill-oriented riders

CHARAKTERISTIK

- ▶ Alu-Rahmen mit integriertem 504 Wh Akku und Shimano Steps 8000 Motor mit max. 70 Nm Drehmoment bei unter 2,9 kg
- ▶ Dem satten AMR-Viergelenkfahwerk gelingt der Spagat zwischen Effizienz und Schluckfreudigkeit
- ▶ Frauenspezifische Kontaktpunkte
- ▶ 29" für tourenorientierte Fahrerinnen, 27.5"+ für technisch versierte, abfahrtsorientierte Fahrerinnen

TARGET GROUP

- ▶ Women who are looking for a do-it-all e-bike that'll never let you down

ZIELGRUPPE

- ▶ Frauen, die nach einem für alles gewappnetem E-Bike suchen, dass sie nie im Stich lässt



// GEOMETRY AND DATA CHARTS / GEOMETRIE UND TECHNISCHE DATEN

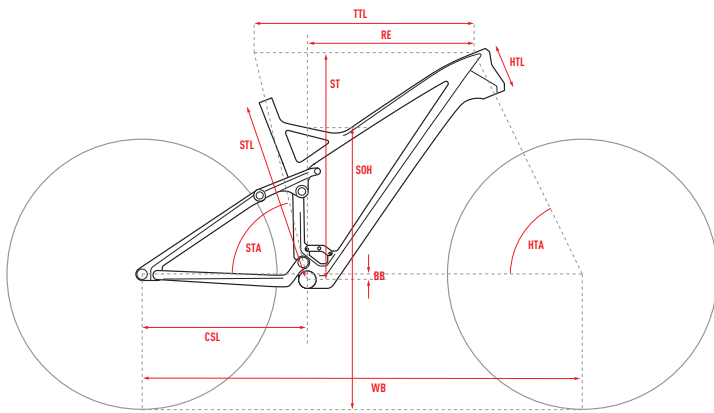

ALL DIMENSIONS IN MM (EXCEPT HTA AND STA IN °)

ALLE MASSE IN MM (AUSNAHME HTA UND STA IN °)

- STL** SEAT TUBE LENGTH
SITZROHRLÄNGE
- CSL** CHAINSTAY LENGTH
KETTENSTREBENLÄNGE
- TTL** TOP TUBE LENGTH
OBERROHRLÄNGE
- HTL** HEADTUBE LENGTH
STEUERROHRLÄNGE
- HTA** HEADTUBE ANGLE
STEUERROHRWINKEL
- STA** SEATTUBE ANGLE
SITZROHRWINKEL
- BB** BB DROP
TRETLAGERABSSENKUNG
- WB** WHEELBASE
RADSTAND
- ST** STACK
STACK
- RE** REACH
REACH
- SOH** STANDOVER HEIGHT
ÜBERSTANDSHÖHE
- SD** HEAD SET DIAMETER (UPPER / LOWER)
STEUERSATZDURCHMESSER (OBEN / UNTEN)
- AS** AXLE STANDARD (REAR / FRONT)
ACHSENSTANDARD (HINTEN / VORNE)
- BS** BOTTOM BRACKET STANDARD
TRETLAGERSTANDARD
- SP** SEAT POST DIAMETER
SITZELSTÜTZENDURCHMESSER
- SH** SHOCK HARDWARE (Ø 8MM)
DÄMPFERBUCHSENMASSE (Ø 8MM)
- SL** SHOCK LENGTH
DÄMPFEREINBAULÄNGE
- ST** SHOCK TRAVEL
DÄMPFERHUB
- FF** FRONT FORK TRAVEL
FEDERWEG VORNE
- FR** REAR WHEEL TRAVEL
FEDERWEG HINTEN
- MS** MIN SADDLE HEIGHT
MIN SITZTELHÖHE
- MX** MAX SADDLE HEIGHT
MAX SITZTELHÖHE
- MI** MIN INSEAM
MIN SCHRITTLÄNGE
- MX** MAX INSEAM
MAX SCHRITTLÄNGE
- SL** STEM LENGTH
VORBAULÄNGE
- HW** HANDLEBAR WIDTH
LENKERBREITE
- CL** CRANK LENGTH
KURBELLÄNGE
- SM** SEATTUBE BOTTLE MOUNT
FLASCHE SATTELROHR
- DM** DOWNTUBE BOTTLE MOUNT
FLASCHE UNTERROHR

STL CSL TTL HTL HTA STA BB WB ST RE SOH

HYBRIDE LANAO FS S6.7+ / S4.7+ / S3.7+ AL W

	STL	CSL	TTL	HTL	HTA	STA	BB	WB	ST	RE	SOH	SD	AS	BS	SP	SH	SL	ST	FF	FR	MS	MX	MI	MX	SL	HW	CL	SM	DM
S	390	455	573	100	66	75.5	20	1185	590	420	744	ZS44/ZS56	148/110	/	31.6	30/30	210	55	140	140	55	760	170	/	0.5				
M	430	455	597	120	66	75.5	20	1212	609	440	758	ZS44/ZS56	148/110	/	31.6	30/30	210	55	140	140	55	760	170	/	0.5				
L	460	455	622	140	66	75.5	20	1241	627	460	776	ZS44/ZS56	148/110	/	31.6	30/30	210	55	140	140	55	760	170	/	0.5				



FLAT // night black / night black / neon pink

LANAO FS S6.7+



MODEL HIGHLIGHTS

- ▶ Equipped with Rock Shox air suspension
- ▶ DT Swiss H 1900 E-bike specific wheelset
- ▶ High-end Maxxis tire choice for added grip and safety

MODELL HIGHLIGHTS

- ▶ Hochwertiges Rock Shox Luftfahrwerk
- ▶ DT Swiss H 1900 E-Bike-Laufräder
- ▶ Hochwertige Maxxis Bereifung für Grip und Sicherheit

Hybride LANAo FS AL	-	DT Swiss H 1900 Spline 35 mm Wheelset 15x110 mm // DT Swiss H 1900 Spline 35 mm Wheelset 12x148 mm	Shimano EC-E6000
Rock Shox YARI RC Debon Air 140 mm	Shimano SLX SL-M7000	JD Dropper Post 31.6 mm	16012
Rock Shox Deluxe RT Air 140 mm	Shimano FC-E8000 34T	Ergon SFC-30	FRH60058
GHOST MTB Dia. 35 mm	Shimano SLX CS-M7000 11-46	Shimano SC-E8000	S-M-L
GHOST Low Rizer MTB 760 mm Rise 15 mm Dia. 35 mm	Magura MT 5 4/4 Piston 203 mm Disc	Shimano DU-E8000	
Shimano XT RD-M8000 Shadow Plus 11-S	Maxxis Minion DHF 3C MaxxTerra Exo 27.5x2.6 // Maxxis Minion DHR II 3C MaxxTerra Exo 27.5x2.8	Shimano BT-E8010 504 Wh	

SIZE	ARTICLENUMBER	NOTES
SIZE S	18YL4011	
SIZE M	18YL4012	
SIZE L	18YL4013	



























MODEL HIGHLIGHTS

- ▶ Sporty Shimano Steps 8000 motor for highest demands
- ▶ Equipped with dropper post
- ▶ Tektro 4-piston brake

MODELL HIGHLIGHTS

- ▶ Sportiver Steps 8000 Antrieb für hohe Ansprüche
- ▶ Mit versenkbarer Variostütze
- ▶ Tektro 4-Kolbenbremsen

 Hybride LANA FS AL	 -	 Rodi Tryp 584x35 mm 32H // Rodi Tryp 584x35 mm 32H	 Shimano DU-E8000
 SR Suntour AION 35 RC DS 140 mm	 Shimano SLX SL-M7000	 Formula DC-511 15x110 mm	 Shimano BT-E8010 504 Wh
 Rock Shox Deluxe RT Air 140 mm	 Shimano FC-E8000 34T	 Formula EHL-148A 12x148 mm	 Shimano EC-E6000
 GHOST MTB Dia. 35 mm	 Shimano SLX CS-M7000 11-46	 JD Dropper Post 31.6 mm	 16012
 GHOST Low Rizer MTB 760 mm Rise 15 mm Dia. 35 mm	 Tektro HD-M805 Slate 4K 4/4 Piston 203 mm Disc	 Selle Italia X-Base	 FRHG0058
 Shimano XT RD-M8000 Shadow Plus 11-S	 Schwalbe Nobby Nic Apex Addix Speedgrip 27.5x2.6 // Schwalbe Nobby Nic Apex Addix Speedgrip 27.5x2.8	 Shimano SC-E8000	 S-M-L

SIZE	ARTICLENUMBER	NOTES
SIZE S	18YL4006	
SIZE M	18YL4007	
SIZE L	18YL4008	



FLAT // star white / night black / neon pink

LANA FS S3.7+



MODEL HIGHLIGHTS

- ▶ Comfortable and sporty bike
- ▶ E-bike specific components
- ▶ Magura MT Thirty2 4/2-piston brake for safe stopping power

MODELL HIGHLIGHTS

- ▶ Komfortabel und sportlich
- ▶ E-Bike-spezifische Anbauteile
- ▶ Magura MT Thirty2 4/2-Kolbenbremse: sicher bremsen

Hybride LANA FS AL	-	Rodi Tryp 584x35 mm 32H // Rodi Tryp 584x35 mm 32H	Shimano DU-E8000
SR Suntour Zeron 35 LOR DS 140 mm	Shimano Deore SL-M6000	Formula DC-511 15x110 mm	Shimano BT-E8010 504 Wh
XFusion O2 Pro RL Air 140 mm	Shimano FC-E8000 34T	Formula EHL-148S 12x148 mm	Shimano EC-E6000
GHOST MTB Dia. 35 mm	Shimano CS-HG500-10 11-42	GHOST Light DC 1 31.6 mm	16012
GHOST Low Rizer MTB 760 mm Rise 15 mm Dia. 35 mm	Magura MT Thirty2 4/2 Piston 203 mm Disc	Selle Italia X-Base	FRHG0058
Shimano Deore RD-M6000 Shadow Plus 10-S	Schwalbe Nobby Nic Apex Addix Speedgrip 27.5x2.6 // Schwalbe Nobby Nic Apex Addix Speedgrip 27.5x2.8	Shimano SC-E8000	S-M-L

SIZE	ARTICLENUMBER	NOTES
SIZE S	18YL4001	
SIZE M	18YL4002	
SIZE L	18YL4003	



// ALLROUND / TRAIL

FEATURES



CHARACTERISTICS

- ▶ Aluminum frame with integrated powerful 504 Wh battery and Shimano Steps 8000 motor with up to 70 Nm torque at less than 2.9 kg
- ▶ Integrated battery
- ▶ 29" for tour-oriented riders, 27.5"+ for more technical trails
- ▶ Custom contact points for women

CHARAKTERISTIK

- ▶ Alu-Rahmen mit integriertem 504 Wh Akku und Shimano Steps 8000 Motor mit max. 70 Nm Drehmoment bei unter 2,9 kg
- ▶ Integrierte Batterie
- ▶ 29" für tourenorientierte Fahrer, 27.5"+ für technischere Trails
- ▶ Frauenspezifische Kontaktpunkte

TARGET GROUP

- ▶ Mountainbiker looking to have fun on an e-bike

ZIELGRUPPE

- ▶ E-Mountainbikerinnen, bei denen Fahrspaß an erster Stelle steht





// GEOMETRY AND DATA CHARTS / GEOMETRIE UND TECHNISCHE DATEN

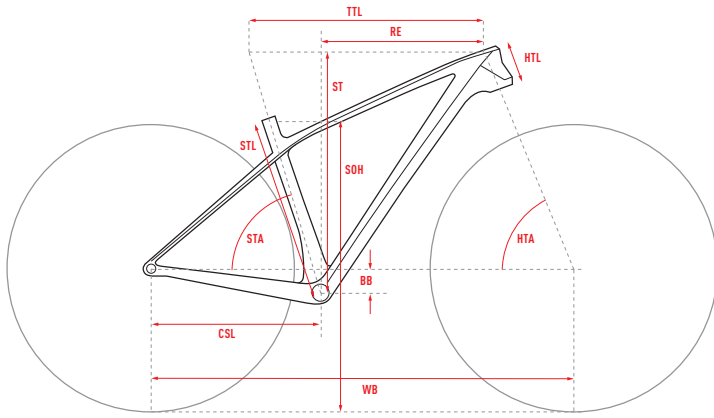

ALL DIMENSIONS IN MM (EXCEPT HTA AND STA IN °)

ALLE MASSE IN MM (AUSNAHME HTA UND STA IN °)

- STL** SEAT TUBE LENGTH
SITZROHRLÄNGE
- CSL** CHAINSTAY LENGTH
KETTENSTREBENLÄNGE
- TTL** TOP TUBE LENGTH
OBERROHRLÄNGE
- HTL** HEADTUBE LENGTH
STEUERROHRLÄNGE
- HTA** HEADTUBE ANGLE
STEUERROHRWINKEL
- STA** SEATTUBE ANGLE
SITZROHRWINKEL
- BB** BB DROP
TRETLAGERABSSENKUNG
- WB** WHEELBASE
RADSTAND
- ST** STACK
STACK
- RE** REACH
REACH
- SOH** STANDOVER HEIGHT
ÜBERSTANDSHÖHE
- HEAD SET DIAMETER (UPPER / LOWER)**
STEUERSATZDURCHMESSER (OBEN / UNTEN)
- AXLE STANDARD (REAR / FRONT)**
ACHSENSTANDARD (HINTEN / VORNE)
- BOTTOM BRACKET STANDARD**
TRETLAGERSTANDARD
- SEAT POST DIAMETER**
SITZELSTÜTZENDURCHMESSER
- SHOCK HARDWARE (Ø 8MM)**
DÄMPFERBUCHSENMASSE (Ø 8MM)
- SHOCK LENGTH**
DÄMPFEREINBAULÄNGE
- SHOCK TRAVEL**
DÄMPFERHUB
- FRONT FORK TRAVEL**
FEDERWEG VORNE
- REAR WHEEL TRAVEL**
FEDERWEG HINTEN
- MIN SADDLE HEIGHT**
MIN SITZTELHÖHE
- MAX SADDLE HEIGHT**
MAX SITZTELHÖHE
- MIN INSEAM**
MIN SCHRITTLÄNGE
- MAX INSEAM**
MAX SCHRITTLÄNGE
- STEM LENGTH**
VORBAULÄNGE
- HANDLEBAR WIDTH**
LENKERBREITE
- CRANK LENGTH**
KURBELLÄNGE
- SEAT TUBE BOTTLE MOUNT**
FLASCHE SITZELROHR
- DOWN TUBE BOTTLE MOUNT**
FLASCHE UNTERROHR

STL CSL TTL HTL HTA STA BB WB ST RE SOH ST DT

HYBRIDE LANAO S6.7+ / S4.7+ / S3.7+ AL W

	STL	CSL	TTL	HTL	HTA	STA	BB	WB	ST	RE	SOH																			
S	380	442.5	599	100	66	73.5	56	1165	620	415	689	ZS44/ZS56	148/110	/	31.6	/	/	/	130	/	55	760	170	/	0.5					
M	420	442.5	615	105	66	73.5	56	1181	625	430	709	ZS44/ZS56	148/110	/	31.6	/	/	/	130	/	55	760	170	0.5	0.5					
L	460	442.5	634	120	66	73.5	56	1203	638	445	728	ZS44/ZS56	148/110	/	31.6	/	/	/	130	/	55	760	170	0.5	0.5					
XL	500	442.5	653	135	66	73.5	56	1224	652	460	762	ZS44/ZS56	148/110	/	31.6	/	/	/	130	/	55	760	170	0.5	0.5					



MODEL HIGHLIGHTS

- ▶ Magura MT 5 4/4-piston disc brakes
- ▶ High-end Maxxis tire choice for added grip and safety
- ▶ DT Swiss H 1900 E-bike specific wheelset

MODELL HIGHLIGHTS

- ▶ Magura MT 5 4/4-Kolbenbremsen
- ▶ Hochwertige Maxxis Bereifung für Grip und Sicherheit
- ▶ DT Swiss H 1900 E-Bike-Laufräder

Hybride LANA0 AL	Shimano XT SL-M8000	JD Dropper Post 31,6 mm	16012
Rock Shox YARI RC Debon Air 130 mm	Shimano FC-E8000 34T	Ergon SME30	FRH60022
GH0ST MTB Dia. 35 mm	Shimano SLX CS-M7000 11-46	Shimano SC-E8000	XS-S-M-L
GH0ST Low Rizer MTB 760 mm Rise 15 mm Dia. 35 mm	Magura MT 5 4/4 Piston 203 mm Disc	Shimano DU-E8000	
Shimano XT RD-M8000 Shadow Plus 11-S	Maxxis Minion DHF 3C MaxxTerra Exo 27.5x2.6 // Maxxis Minion DHR II 3C MaxxTerra Exo 27.5x2.8	Shimano BT-E8010 504 Wh	
DT Swiss H 1900 Spline 35 mm Wheelset 15x110 mm // DT Swiss H 1900 Spline 35 mm Wheelset 12x148 mm		Shimano EC-E6000	

SIZE	ARTICLENUMBER	NOTES
SIZE XS	18YL1013	
SIZE S	18YL1014	
SIZE M	18YL1015	
SIZE L	18YL1016	



MODEL HIGHLIGHTS

- ▶ Sporty Shimano Steps 8000 motor for highest demands
- ▶ Equipped with dropper post

MODELL HIGHLIGHTS

- ▶ Sportiver Steps 8000 Antrieb für hohe Ansprüche
- ▶ Mit versenkbarer Variostütze

Hybride LANA AL	Shimano SLX SL-M7000	Formula DC-711 15x110 mm	Shimano BT-E8010 504 Wh
SR Suntour Raidon 34 LOR DS AIR 130 mm	Shimano FC-E8000 34T	Formula EHL-148A 12x148 mm	Shimano EC-E6000
GHOST MTB Dia. 35 mm	Shimano SLX CS-M7000 11-46	JD Dropper Post 31.6 mm	16012
GHOST Low Rizer MTB 760 mm Rise 15 mm Dia. 35 mm	Tektro HD-M805 Slate 4K 4/4 Piston 203 mm Disc	Selle Italia X-Base	FRHG0022
Shimano XT RD-M8000 Shadow Plus 11-S	Schwalbe Nobby Nic Apex Addix Speedgrip 27.5x2.6 // Schwalbe Nobby Nic Apex Addix Speedgrip 27.5x2.8	Shimano SC-E8000	XS-S-M-L
-	Rodi Tryp 584x35 mm 32H // Rodi Tryp 584x35 mm 32H	Shimano DU-E8000	

SIZE	ARTICLENUMBER	NOTES
SIZE XS	18YL1007	
SIZE S	18YL1008	
SIZE M	18YL1009	
SIZE L	18YL1010	



FLAT // star white / night black / neon pink



MODEL HIGHLIGHTS

- ▶ High-end Maxxis tire choice for added grip and safety
- ▶ E-bike specific components

MODELL HIGHLIGHTS

- ▶ Hochwertige Maxxis Bereifung für Grip und Sicherheit
- ▶ E-Bike-spezifische Anbauteile

Hybride LANA0 AL	Shimano Deore SL-M6000	Formula DC-511 15x110 mm	Shimano BT-E8010 504 Wh
SR Suntour XCR 34 LOR AIR 130 mm	Shimano FC-E8000 34T	Formula EHL-148S 12x148 mm	Shimano EC-E6000
GHOST MTB Dia. 35 mm	Shimano CS-HG500-10 11-42	GHOST Light DC 1 31.6 mm	16012
GHOST Low Rizer MTB 760 mm Rise 15 mm Dia. 35 mm	Magura MT Thirty2.4/2 Piston 203 mm Disc	Selle Italia X-Base	FRH60022
Shimano Deore RD-M6000 Shadow Plus 10-S	Schwalbe Nobby Nic Apex Addix Speedgrip 27.5x2.6 // Schwalbe Nobby Nic Apex Addix Speedgrip 27.5x2.8	Shimano SC-E8000	XS-S-M-L
-	Rodi Tryp 584x35 mm 32H // Rodi Tryp 584x35 mm 32H	Shimano DU-E8000	

SIZE	ARTICLENUMBER	NOTES
SIZE XS	18YL1001	
SIZE S	18YL1002	
SIZE M	18YL1003	
SIZE L	18YL1004	



BATTERY RECHARGEABLE DIRECTLY ON THE BIKE // AKKU IN VERBAUTEM ZUSTAND WIEDERAUFLADBAR

E-BIKE SPECIFIC COMPONENTS // E-BIKE-SPEZIFISCHE KOMponentEN

FAST ROLLING SCHWALBE TIRES // LEICHT ROLLENDE SCHWALBE-BEREIFUNG

29" FÜR RELAXED CRUISING // 29" FÜR ENTSPANNTE TOUREN

INTEGRATED BATTERY DESIGN // INTEGRIERTE BATTERIE

// XC & TOUR / TOUR

FEATURES



CHARACTERISTICS

- ▶ 500 Wh integrated battery, motor with up to 75 Nm torque
- ▶ Easy to adjust suspension forks
- ▶ Carrier and fender mounting points

CHARAKTERISTIK

- ▶ Integrierter 500 Wh Akku, Motor mit bis zu 75 Nm Drehmoment
- ▶ Leicht einzustellende Federgabeln
- ▶ Gepäckträger- und Schutzblechaufnahmen

TARGET GROUP

- ▶ Riders looking for the perfect combination of power and comfort

ZIELGRUPPE

- ▶ Fahrer, die nach der perfekten Kombination aus Power und Komfort suchen



// GEOMETRY AND DATA CHARTS / GEOMETRIE UND TECHNISCHE DATEN

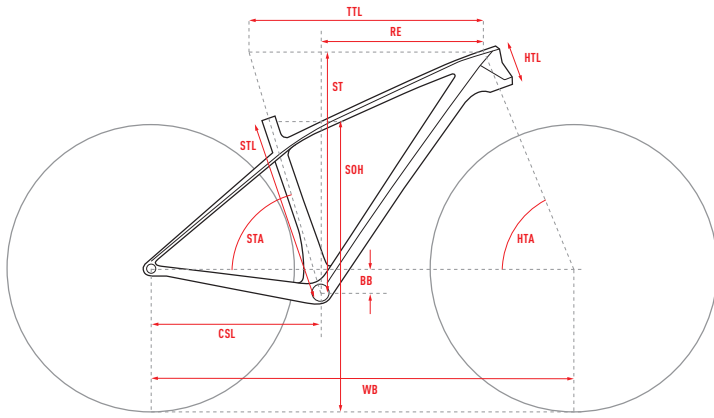

ALL DIMENSIONS IN MM (EXCEPT HTA AND STA IN °)

ALLE MASSE IN MM (AUSNAHME HTA UND STA IN °)

- STL** SEAT TUBE LENGTH
SITZROHRLÄNGE
- CSL** CHAINSTAY LENGTH
KETTENSTREBENLÄNGE
- TTL** TOP TUBE LENGTH
OBERROHRLÄNGE
- HTL** HEADTUBE LENGTH
STEUERROHRLÄNGE
- HTA** HEADTUBE ANGLE
STEUERROHRWINKEL
- STA** SEATTUBE ANGLE
SITZROHRWINKEL
- BB** BB DROP
TRETLAGERABSSENKUNG
- WB** WHEELBASE
RADSTAND
- ST** STACK
STACK
- RE** REACH
REACH
- SOH** STANDOVER HEIGHT
ÜBERSTANDSHÖHE
- HEAD SET DIAMETER (UPPER / LOWER)
STEUERSATZDURCHMESSER (OBEN / UNTEN)
- AXLE STANDARD (REAR / FRONT)
ACHSENSTANDARD (HINTEN / VORNE)
- BOTTOM BRACKET STANDARD
TRETLAGERSTANDARD
- SEAT POST DIAMETER
SITZSTÜTZENDURCHMESSER
- SHOCK HARDWARE (Ø 8MM)
DÄMPFERBUCHSENMASSE (Ø 8MM)
- SHOCK LENGTH
DÄMPFEREINBAULÄNGE
- SHOCK TRAVEL
DÄMPFERHUB
- FRONT FORK TRAVEL
FEDERWEG VORNE
- REAR WHEEL TRAVEL
FEDERWEG HINTEN
- MIN SADDLE HEIGHT
MIN SITZTELHÖHE
- MAX SADDLE HEIGHT
MAX SITZTELHÖHE
- MIN INSEAM
MIN SCHRITTLÄNGE
- MAX INSEAM
MAX SCHRITTLÄNGE
- STEM LENGTH
VORBAULÄNGE
- HANDLEBAR WIDTH
LENKERBREITE
- CRANK LENGTH
KURBELLÄNGE
- SEAT TUBE BOTTLE MOUNT
FLASCHE SITZROHR
- DOWNTUBE BOTTLE MOUNT
FLASCHE UNTERROHR

STL CSL TTL HTL HTA STA BB WB ST RE SOH ST DT

HYBRIDE TERU X B.9 AL U

	STL	CSL	TTL	HTL	HTA	STA	BB	WB	ST	RE	SOH																		
S	380	472.5	592	100	66.5	73.5	60	1180	616	410	697	ZS44/ZS56	135/110	/	31.6	/	/	/	120	/	55	740	175	0.5	/				
M	420	472.5	608	105	66.5	73.5	60	1196	620	424	709	ZS44/ZS56	135/110	/	31.6	/	/	/	120	/	55	740	175	0.5	/				
L	460	472.5	630	115	66.5	73.5	60	1220	629	444	732	ZS44/ZS56	135/110	/	31.6	/	/	/	120	/	55	740	175	0.75	/				
XL	500	472.5	650	130	66.5	73.5	60	1242	643	460	765	ZS44/ZS56	135/110	/	31.6	/	/	/	120	/	55	740	175	0.75	/				



MODEL HIGHLIGHTS

- ▶ Fast paced 29" E-bike with stable geometry
- ▶ Bosch Performance CX motor
- ▶ Color option available

MODELL HIGHLIGHTS

- ▶ Schnelles 29" E-Bike mit lauffruhiger Geometrie
- ▶ Bosch Performance CX Motor
- ▶ Mit Farboption

Hybride TERUX AL	Shimano Deore SL-M610	Shimano HB-TX505 OR	Bosch Power Pack 500 Wh
RST Aerial 29 Air TNL 120 mm	Miranda Delta 15T	Shimano FH-RM33 OR	Bosch Charger 2 Ah
GHOST MTB Dia. 31.8 mm	Shimano CS-HG50-10 11-36	GHOST SP-DC1 31.6 mm	14358
GHOST Low Rizer MTB 740 mm Rise 15 mm Dia. 31.8 mm	Shimano BR-M315 2/2 Piston 180 mm	GHOST VLI353	EZ1954
Shimano XT RD-M781 10-S Shadow Design	Schwalbe Tough Tom 2.25 // Schwalbe Rapid Rob 2.25	Bosch Purion	S-M-L-XL
-	Rodi Blackrock 622x21 mm 32H // Rodi Blackrock 622x21 mm 32H	Bosch Performance CX	

SIZE	ARTICLENUMBER	NOTES
SIZE S	18HY5905	
SIZE M	18HY5906	
SIZE L	18HY5907	
SIZE XL	18HY5908	

























MODEL HIGHLIGHTS

- ▶ Fast paced 29" E-bike with stable geometry
- ▶ Bosch Performance CX motor
- ▶ Color option available

MODELL HIGHLIGHTS

- ▶ Schnelles 29" E-Bike mit laufruhiger Geometrie
- ▶ Bosch Performance CX Motor
- ▶ Mit Farboption

 Hybride TERUX AL	 Shimano Deore SL-M610	 Shimano HB-TX505 QR	 Bosch Power Pack 500 Wh
 RST Aerial 29 Air TNL 120 mm	 Miranda Delta 15T	 Shimano FH-RM33 QR	 Bosch Charger 2 Ah
 GHOSH MTB Dia. 31.8 mm	 Shimano CS-HG50-10 11-36	 GHOSH SP-DC1 31.6 mm	 16358
 GHOSH Low Rizer MTB 740 mm Rise 15 mm Dia. 31.8 mm	 Shimano BR-M315 2/2 Piston 180 mm	 GHOSH VL1353	 EZ1954
 Shimano XT RD-M781 10-S Shadow Design	 Schwalbe Tough Tom 2.25 // Schwalbe Rapid Rob 2.25	 Bosch Purion	 S-M-L-XL
 Rodri Blackrock 622x21 mm 32H // Rodri Blackrock 622x21 mm 32H	 Bosch Performance CX		

SIZE	ARTICLENUMBER	NOTES
SIZE S	18HY5911	
SIZE M	18HY5912	
SIZE L	18HY5913	
SIZE XL	18HY5914	



// XC & TOUR / TOUR

FEATURES



CHARACTERISTICS

- ▶ 500 Wh integrated battery, motor with up to 75 Nm torque
- ▶ High-quality saddles and powerful brakes
- ▶ Easy to adjust suspension forks

CHARAKTERISTIK

- ▶ Integrierter 500 Wh Akku, Motor mit bis zu 75 Nm Drehmoment
- ▶ Hochwertige Sättel und standfeste Bremsen
- ▶ Leicht einzustellende Federgabeln

TARGET GROUP

- ▶ Riders looking for the perfect combination of power and comfort

ZIELGRUPPE

- ▶ Fahrer, die nach der perfekten Kombination aus Power und Komfort suchen



// GEOMETRY AND DATA CHARTS / GEOMETRIE UND TECHNISCHE DATEN

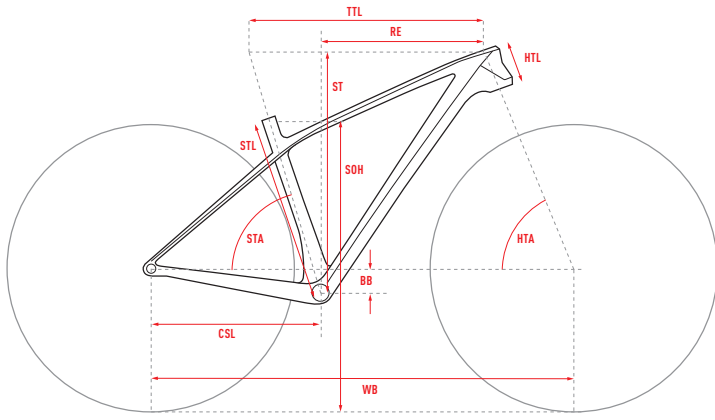

ALL DIMENSIONS IN MM (EXCEPT HTA AND STA IN °)

ALLE MASSE IN MM (AUSNAHME HTA UND STA IN °)

- STL** SEAT TUBE LENGTH
SITZROHRLÄNGE
- CSL** CHAINSTAY LENGTH
KETTENSTREBENLÄNGE
- TTL** TOP TUBE LENGTH
OBERROHRLÄNGE
- HTL** HEADTUBE LENGTH
STEUERROHRLÄNGE
- HTA** HEADTUBE ANGLE
STEUERROHRWINKEL
- STA** SEATTUBE ANGLE
SITZROHRWINKEL
- BB** BB DROP
TRETLAGERABSSENKUNG
- WB** WHEELBASE
RADSTAND
- ST** STACK
STACK
- RE** REACH
REACH
- SOH** STANDOVER HEIGHT
ÜBERSTANDSHÖHE
- HEAD SET DIAMETER (UPPER / LOWER)**
STEUERSATZDURCHMESSER (OBEN / UNTEN)
- AXLE STANDARD (REAR / FRONT)**
ACHSENSTANDARD (HINTEN / VORNE)
- BOTTOM BRACKET STANDARD**
TRETLAGERSTANDARD
- SEAT POST DIAMETER**
SITZSTÜTZENDURCHMESSER
- SHOCK HARDWARE (Ø 8MM)**
DÄMPFERBUCHSENMASSE (Ø 8MM)
- SHOCK LENGTH**
DÄMPFEREINBAULÄNGE
- SHOCK TRAVEL**
DÄMPFERHUB
- FRONT FORK TRAVEL**
FEDERWEG VORNE
- REAR WHEEL TRAVEL**
FEDERWEG HINTEN
- MIN SADDLE HEIGHT**
MIN SITZELHÖHE
- MAX SADDLE HEIGHT**
MAX SITZELHÖHE
- MIN INSEAM**
MIN SCHRITTLÄNGE
- MAX INSEAM**
MAX SCHRITTLÄNGE
- STEM LENGTH**
VORBAULÄNGE
- HANDLEBAR WIDTH**
LENKERBREITE
- CRANK LENGTH**
KURBELLÄNGE
- SEAT TUBE BOTTLE MOUNT**
FLASCHE SITZELROHR
- DOWNTUBE BOTTLE MOUNT**
FLASCHE UNTERROHR

STL CSL TTL HTL HTA STA BB WB ST RE SOH ST DT

HYBRIDE TERU B7.7+ / B5.7+ / B2.7+ AL U/W

	XS	S	M	L	XL																				
STL	360	472.5	580	100	66.5	73.5	60	1168	616	398	670	ZS44/ZS56	148/110	/	31.6	/	/	/	120	/	55	740	170	0.5	/
CSL	380	472.5	592	100	66.5	73.5	60	1180	616	410	685	ZS44/ZS56	148/110	/	31.6	/	/	/	120	/	55	740	170	0.5	/
TTL	420	472.5	608	105	66.5	73.5	60	1196	620	424	697	ZS44/ZS56	148/110	/	31.6	/	/	/	120	/	55	740	170	0.5	/
HTL	460	472.5	630	115	66.5	73.5	60	1220	629	444	720	ZS44/ZS56	148/110	/	31.6	/	/	/	120	/	55	740	170	0.75	/
HTA	500	472.5	650	130	66.5	73.5	60	1242	643	460	753	ZS44/ZS56	148/110	/	31.6	/	/	/	120	/	55	740	170	0.75	/

HYBRIDE TERU B7.9 / B5.9 / B2.9 AL U

	S	M	L	XL																					
STL	380	472.5	592	100	66.5	73.5	60	1180	616	410	697	ZS44/ZS56	135/110	/	31.6	/	/	/	120	/	55	740	170	0.5	/
CSL	420	472.5	608	105	66.5	73.5	60	1196	620	424	709	ZS44/ZS56	135/110	/	31.6	/	/	/	120	/	55	740	170	0.5	/
TTL	460	472.5	630	115	66.5	73.5	60	1220	629	444	732	ZS44/ZS56	135/110	/	31.6	/	/	/	120	/	55	740	170	0.75	/
HTL	500	472.5	650	130	66.5	73.5	60	1242	643	460	765	ZS44/ZS56	135/110	/	31.6	/	/	/	120	/	55	740	170	0.75	/



FLAT // night black / urban gray / neon green



MODEL HIGHLIGHTS

- ▶ Rock Shox YARI fork
- ▶ Magura MT 5 4/4-piston brakes
- ▶ Different color and wheel size option available

MODELL HIGHLIGHTS

- ▶ Rock Shox YARI Federgabel
- ▶ Magura MT 5 4/4-Kolbenbremsen
- ▶ Mit Farb- und Laufradoption

Hybride TERU AL	Shimano XT SL-M8000	Formula DC-711 15x110 mm	Bosch Power Pack 500 Wh
Rock Shox YARI RC Debon Air 120 mm	FSA CK-745 15T	Formula EHL-148A 12x148 mm	Bosch Charger 4 Ah
GH0ST MTB Dia. 31.8 mm	Shimano SLX CS-M7000 11-46	GH0ST Light DC 1 31.6 mm	16012
GH0ST Low Rizer MTB 740 mm Rise 25 mm Dia. 31.8 mm	Magura MT 5 4/4 Piston 203 mm Disc	Ergon SM-30	FRH60022
Shimano XT RD-M8000 Shadow Plus 11-S	Schwalbe Nobby Nic Apex Addix Speedgrip 27.5x2.6 // Schwalbe Nobby Nic Apex Addix Speedgrip 27.5x2.6	Bosch Purion	S-M-L-XL
Rodri Tryp 584x30 mm 32H // Rodri Tryp 584x30 mm 32H	Bosch Performance CX		

SIZE	ARTICLENUMBER	NOTES
SIZE S	18YT1025	
SIZE M	18YT1026	
SIZE L	18YT1027	
SIZE XL	18YT1028	



MODEL HIGHLIGHTS

- ▶ Rock Shox YARI fork
- ▶ Magura MT 5 4/4-piston brakes
- ▶ Different color and wheel size option available

MODELL HIGHLIGHTS

- ▶ Rock Shox YARI Federgabel
- ▶ Magura MT 5 4/4-Kolbenbremsen
- ▶ Mit Farb- und Laufradoption

Hybride TERU AL	Shimano XT SL-M8000	Formula DC-711 15x110 mm	Bosch Power Pack 500 Wh
Rock Shox YARI RC Debon Air 120 mm	FSA CK-745 15T	Formula EHL-148A 12x148 mm	Bosch Charger 4 Ah
GHOST MTB Dia. 31.8 mm	Shimano SLX CS-M7000 11-46	GHOST Light DC 1 31.6 mm	16012
GHOST Low Rizer MTB 740 mm Rise 25 mm Dia. 31.8 mm	Magura MT 5 4/4 Piston 203 mm Disc	Ergon SM-30	FRHG0022
Shimano XT RD-M8000 Shadow Plus 11-S	Schwalbe Nobby Nic Apex Addix Speedgrip 27.5x2.6 // Schwalbe Nobby Nic Apex Addix Speedgrip 27.5x2.6	Bosch Purion	S-M-L-XL
Rodri Tryp 584x30 mm 32H // Rodri Tryp 584x30 mm 32H		Bosch Performance CX	

SIZE	ARTICLENUMBER	NOTES
SIZE S	18YT1031	
SIZE M	18YT1032	
SIZE L	18YT1033	
SIZE XL	18YT1034	



FLAT // night black / urban gray / neon green



MODEL HIGHLIGHTS

- ▶ Rock Shox YARI fork
- ▶ Magura MT 5, 4/4-piston brakes
- ▶ Different color and wheel size option available

MODELL HIGHLIGHTS

- ▶ Rock Shox YARI Federgabel
- ▶ Magura MT 5, 4/4-Kolbenbremsen
- ▶ Mit Farb- und Laufradoption

Hybride TERU AL	Shimano XT SL-M8000	Formula DC-711 15x110 mm	Bosch Power Pack 500 Wh
Rock Shox YARI RC Debon Air 120 mm	FSA CK-745 15T	Formula DC 22 QR	Bosch Charger 4 Ah
GHOSH MTB Dia. 31.8 mm	Shimano SLX CS-M7000 11-46	GHOSH Light DC 1 31.6 mm	16012
GHOSH Low Rizer MTB 740 mm Rise 25 mm Dia. 31.8 mm	Magura MT 5 4/4 Piston 203 mm Disc	Ergon SM-30	E21954
Shimano XT RD-M8000 Shadow Plus 11-S	Schwalbe Nobby Nic Performance Addix 29x2.35 // Schwalbe Nobby Nic Performance Addix 29x2.35	Bosch Purion	S-M-L-XL
Rodri Tryp 622x25 mm 32H // Rodri Tryp 622x25 mm 32H	Bosch Performance CX		

SIZE	ARTICLENUMBER	NOTES
SIZE S	18YT2025	
SIZE M	18YT2026	
SIZE L	18YT2027	
SIZE XL	18YT2028	

























MODEL HIGHLIGHTS

- ▶ Rock Shox YARI fork
- ▶ Magura MT 5 4/4-piston disc brakes
- ▶ Different color and wheel size option available

MODELL HIGHLIGHTS

- ▶ Rock Shox YARI Federgabel
- ▶ Magura MT 5 4/4-Kolbenbremsen
- ▶ Mit Farb- und Laufradoption

 Hybride TERU AL	 Shimano XT SL-M8000	 Formula DC-711 15x110 mm	 Bosch Power Pack 500 Wh
 Rock Shox YARI RC Debon Air 120 mm	 FSA CK-745 15T	 Formula DC 22 QR	 Bosch Charger 4 Ah
 GHOST MTB Dia. 31.8 mm	 Shimano SLX CS-M7000 11-46	 GHOST Light DC 1 31.6 mm	 16012
 GHOST Low Rizer MTB 740 mm Rise 25 mm Dia. 31.8 mm	 Magura MT 5 4/4 Piston 203 mm Disc	 Ergon SM-30	 EZ1954
 Shimano XT RD-M8000 Shadow Plus 11-S	 Schwalbe Nobby Nic Performance Addix 29x2.35 // Schwalbe Nobby Nic Performance Addix 29x2.35	 Bosch Purion	 S-M-L-XL
 -	 Rodi Tryp 622x25 mm 32H // Rodi Tryp 622x25 mm 32H	 Bosch Performance CX	

SIZE	ARTICLENUMBER	NOTES
SIZE S	18Y12031	
SIZE M	18Y12032	
SIZE L	18Y12033	
SIZE XL	18Y12034	



FLAT // star white / night black / neon pink

TERU B5.7+
HYBRIDE



MODEL HIGHLIGHTS

- ▶ Bosch Performance CX motor
- ▶ Shimano XT 11-speed drivetrain
- ▶ Custom contact points for women

MODELL HIGHLIGHTS

- ▶ Bosch Performance CX Motor
- ▶ Shimano XT 11-fach Schaltung
- ▶ Frauenspezifische Kontaktpunkte

Hybride TERU AL	Shimano SLX SL-M7000	Formula DC-711 15x110 mm	Bosch Power Pack 500 Wh
SR Suntour Raidon 34 LOR DS AIR 120 mm	FSA CK-745 15T	Formula EHL-148S 12x148 mm	Bosch Charger 4 Ah
GHOST MTB Dia. 31.8 mm	Shimano SLX CS-M7000 11-46	GHOST Light DC 1 31.6 mm	16012
GHOST Low Rizer MTB 740 mm Rise 25 mm Dia. 31.8 mm	Tektro HD-M805 Slate 4K 4/4 Piston 203 mm Disc	Ergon SFC-30	FRHG0022
Shimano XT RD-M8000 Shadow Plus 11-S	Schwalbe Nobby Nic Apex Addix Speedgrip 27.5x2.6 // Schwalbe Nobby Nic Apex Addix Speedgrip 27.5x2.6	Bosch Purion	XS-S-M-L
Rodri Tryp 584x30 mm 32H // Rodri Tryp 584x30 mm 32H	Bosch Performance CX		

SIZE	ARTICLENUMBER	NOTES
SIZE XS	18YT3019	
SIZE S	18YT3020	
SIZE M	18YT3021	
SIZE L	18YT3022	

























MODEL HIGHLIGHTS

- ▶ Bosch Performance CX motor
- ▶ Shimano XT 11-speed drivetrain
- ▶ Different color and wheel size option available

MODELL HIGHLIGHTS

- ▶ Bosch Performance CX Motor
- ▶ Shimano XT 11-fach Schaltung
- ▶ Mit Farb- und Laufradoption

 Hybride TERU AL	 Shimano SLX SL-M7000	 Formula DC-711 15x110 mm	 Bosch Power Pack 500 Wh
 SR Suntour Raidon 34 LOR DS AIR 120 mm	 FSA CK-745 15T	 Formula EHL-148S 12x148 mm	 Bosch Charger 4 Ah
 GHOST MTB Dia. 31.8 mm	 Shimano SLX CS-M7000 11-46	 GHOST Light DC 1 31.6 mm	 16012
 GHOST Low Rizer MTB 740 mm Rise 25 mm Dia. 31.8 mm	 Tektro HD-M805 Slate 4K 4/4 Piston 203 mm Disc	 Selle Italia X-Base	 FRHG0022
 Shimano XT RD-M8000 Shadow Plus 11-S	 Schwalbe Nobby Nic Apex Addix Speedgrip 27.5x2.6 // Schwalbe Nobby Nic Apex Addix Speedgrip 27.5x2.6	 Bosch Purion	 S-M-L-XL
 -	 Rodi Tryp 584x30 mm 32H // Rodi Tryp 584x30 mm 32H	 Bosch Performance CX	

SIZE	ARTICLENUMBER	NOTES
SIZE S	18YT1019	
SIZE M	18YT1020	
SIZE L	18YT1021	
SIZE XL	18YT1022	



MODEL HIGHLIGHTS

- ▶ Bosch Performance CX motor
- ▶ Shimano XT 11-speed drivetrain
- ▶ Custom contact points for women

MODELL HIGHLIGHTS

- ▶ Bosch Performance CX Motor
- ▶ Shimano XT 11-fach Schaltung
- ▶ Frauenspezifische Kontaktpunkte

Hybride TERU AL	Shimano SLX SL-M7000	Formula DC-711 15x110 mm	Bosch Power Pack 500 Wh
SR Suntour Raidon 34 LOR DS AIR 120 mm	FSA CK-745 15T	Formula EHL-148S 12x148 mm	Bosch Charger 4 Ah
GHOST MTB Dia. 31.8 mm	Shimano SLX CS-M7000 11-46	GHOST Light DC 1 31.6 mm	16012
GHOST Low Rizer MTB 740 mm Rise 25 mm Dia. 31.8 mm	Tektro HD-M805 Slate 4K 4/4 Piston 203 mm Disc	Ergon SFC-30	FRHG0022
Shimano XT RD-M8000 Shadow Plus 11-S	Schwalbe Nobby Nic Apex Addix Speedgrip 27.5x2.6 // Schwalbe Nobby Nic Apex Addix Speedgrip 27.5x2.6	Bosch Purion	XS-S-M-L
Rodri Tryp 584x30 mm 32H // Rodri Tryp 584x30 mm 32H	Bosch Performance CX		

SIZE	ARTICLENUMBER	NOTES
SIZE XS	18YT3013	
SIZE S	18YT3014	
SIZE M	18YT3015	
SIZE L	18YT3016	

























MODEL HIGHLIGHTS

- ▶ Bosch Performance CX motor
- ▶ Shimano XT 11-speed drivetrain
- ▶ Different color and wheel size option available

MODELL HIGHLIGHTS

- ▶ Bosch Performance CX Motor
- ▶ Shimano XT 11-fach Schaltung
- ▶ Mit Farb- und Laufradoption

 Hybride TERU AL	 Shimano SLX SL-M7000	 Formula DC-711 15x110 mm	 Bosch Power Pack 500 Wh
 SR Suntour Raidon 34 LOR DS AIR 120 mm	 FSA CK-745 15T	 Formula EHL-148S 12x148 mm	 Bosch Charger 4 Ah
 GHOST MTB Dia. 31.8 mm	 Shimano SLX CS-M7000 11-46	 GHOST Light DC 1 31.6 mm	 16012
 GHOST Low Rizer MTB 740 mm Rise 25 mm Dia. 31.8 mm	 Tektro HD-M805 Slate 4K 4/4 Piston 203 mm Disc	 Selle Italia X-Base	 FRHG0022
 Shimano XT RD-M8000 Shadow Plus 11-S	 Schwalbe Nobby Nic Apex Addix Speedgrip 27.5x2.6 // Schwalbe Nobby Nic Apex Addix Speedgrip 27.5x2.6	 Bosch Purion	 S-M-L-XL
 Rodi Tryp 584x30 mm 32H // Rodi Tryp 584x30 mm 32H	 Bosch Performance CX		

SIZE	ARTICLENUMBER	NOTES
SIZE S	18Y11013	
SIZE M	18Y11014	
SIZE L	18Y11015	
SIZE XL	18Y11016	



MODEL HIGHLIGHTS

- ▶ Bosch Performance CX motor
- ▶ Shimano XT 11-speed drivetrain
- ▶ Different color and wheel size option available

MODELL HIGHLIGHTS

- ▶ Bosch Performance CX Motor
- ▶ Shimano XT 11-fach Schaltung
- ▶ Mit Farb- und Laufradoption

Hybride TERU AL	Shimano SLX SL-M7000	Formula DC-711 15x110 mm	Bosch Power Pack 500 Wh
SR Suntour Raidon 34 LOR DS AIR 120 mm	FSA CK-745 15T	Formula DC 22 QR	Bosch Charger 4 Ah
GHOSH MTB Dia. 31.8 mm	Shimano SLX CS-M7000 11-46	GHOSH Light DC 1 31.6 mm	16012
GHOSH Low Rizer MTB 740 mm Rise 25 mm Dia. 31.8 mm	Tektro HD-M805 Slate 4K 4/4 Piston 203 mm Disc	Selle Italia X-Base	EZ1954
Shimano XT RD-M8000 Shadow Plus 11-S	Schwalbe Nobby Nic Performance Addix 29x2.25 // Schwalbe Nobby Nic Performance Addix 29x2.25	Bosch Purion	S-M-L-XL
Rodri Blackrock 622x21 mm 32H // Rodri Blackrock 622x21 mm 32H	Bosch Performance CX		

SIZE	ARTICLENUMBER	NOTES
SIZE S	18YT2019	
SIZE M	18YT2020	
SIZE L	18YT2021	
SIZE XL	18YT2022	



MODEL HIGHLIGHTS

- ▶ Bosch Performance CX motor
- ▶ Shimano XT 11-speed drivetrain
- ▶ Different color and wheel size option available

MODELL HIGHLIGHTS

- ▶ Bosch Performance CX Motor
- ▶ Shimano XT 11-fach Schaltung
- ▶ Mit Farb- und Laufradoption

Hybride TERU AL	Shimano SLX SL-M7000	Formula DC-711 15x110 mm	Bosch Power Pack 500 Wh
SR Suntour Raidon 34 LOR DS AIR 120 mm	FSA CK-745 15T	Formula DC 22 QR	Bosch Charger 4 Ah
GHOST MTB Dia. 31.8 mm	Shimano SLX CS-M7000 11-46	GHOST Light DC 1 31.6 mm	16012
GHOST Low Rizer MTB 740 mm Rise 25 mm Dia. 31.8 mm	Tektro HD-M805 Slate 4K 4/4 Piston 203 mm Disc	Selle Italia X-Base	E21954
Shimano XT RD-M8000 Shadow Plus 11-S	Schwalbe Nobby Nic Performance Addix 29x2.25 // Schwalbe Nobby Nic Performance Addix 29x2.25	Bosch Purion	S-M-L-XL
-	Rodi Blackrock 622x21 mm 32H // Rodi Blackrock 622x21 mm 32H	Bosch Performance CX	

SIZE	ARTICLENUMBER	NOTES
SIZE S	18Y12013	
SIZE M	18Y12014	
SIZE L	18Y12015	
SIZE XL	18Y12016	



FLAT // night black / neon yellow

27.5" AL **TERU** B2.7+
HYBRIDE



MODEL HIGHLIGHTS

- ▶ Bosch Performance CX motor
- ▶ Sturdy suspension fork catering higher demands
- ▶ Different color and wheel size option available

MODELL HIGHLIGHTS

- ▶ Bosch Performance CX Motor
- ▶ Steife Federgabel für höhere Belastungen
- ▶ Mit Farb- und Laufradoption

Hybride TERU AL	Shimano Deore SL-M6000	Formula DC-511 15x110 mm	Bosch Power Pack 500 Wh
SR Suntour XCR 34 LOR 120 mm	FSA CK-310 15T	Formula EHL-148S 12x148 mm	Bosch Charger 4 Ah
GHOST MTB Dia. 31.8 mm	Shimano CS-HG500-10 11-42	GHOST Light DC 1 31.6 mm	16012
GHOST Low Rizer MTB 740 mm Rise 25 mm Dia. 31.8 mm	Tektro HD-M285 2/2 Piston 203/180 mm Disc	Selle Italia X-Base	FRH60022
Shimano Deore RD-M6000 Shadow Plus 10-S	Schwalbe Smart Sam K-Guard 27.5x2.6 // Schwalbe Smart Sam K-Guard 27.5x2.6	Bosch Purion	S-M-L-XL
Rodri Tryp 584x30 mm 32H // Rodri Tryp 584x30 mm 32H	Bosch Performance CX		

SIZE	ARTICLENUMBER	NOTES
SIZE S	18YT1001	
SIZE M	18YT1002	
SIZE L	18YT1003	
SIZE XL	18YT1004	

























MODEL HIGHLIGHTS

- ▶ Bosch Performance CX motor
- ▶ Shimano Deore 10-speed drivetrain
- ▶ Custom contact points for women

MODELL HIGHLIGHTS

- ▶ Bosch Performance CX Motor
- ▶ Shimano Deore 10-fach Schaltung
- ▶ Frauenspezifische Kontaktpunkte

 Hybride TERU AL	 Shimano Deore SL-M6000	 Formula DC-511 15x110 mm	 Bosch Power Pack 500 Wh
 SR Suntour XCR 34 LOR 120 mm	 FSA CK-310 15T	 Formula EHL-148S 12x148 mm	 Bosch Charger 4 Ah
 GHOST MTB Dia. 31.8 mm	 Shimano CS-HG500-10 11-42	 GHOST Light DC 1 31.6 mm	 16012
 GHOST Low Rizer MTB 740 mm Rise 25 mm Dia. 31.8 mm	 Tektro HD-M285 2/2 Piston 203/180 mm Disc	 Ergon SFC-30	 FRHG0022
 Shimano Deore RD-M6000 Shadow Plus 10-S	 Schwalbe Smart Sam K-Guard 27.5x2.6 // Schwalbe Smart Sam K-Guard 27.5x2.6	 Bosch Purion	 XS-S-M-L
 Rodri Tryp 584x30 mm 32H // Rodri Tryp 584x30 mm 32H		 Bosch Performance CX	

SIZE	ARTICLENUMBER	NOTES
SIZE XS	18Y13001	
SIZE S	18Y13002	
SIZE M	18Y13003	
SIZE L	18Y13004	



NEON FLAT // neon green / night black

TERU B2.7+
HYBRIDE



MODEL HIGHLIGHTS

- ▶ Bosch Performance CX motor
- ▶ Sturdy suspension fork catering higher demands
- ▶ Different color and wheel size option available

MODELL HIGHLIGHTS

- ▶ Bosch Performance CX Motor
- ▶ Steife Federgabel für höhere Belastungen
- ▶ Mit Farb- und Laufradoption

Hybride TERU AL	Shimano Deore SL-M6000	Formula DC-511 15x110 mm	Bosch Power Pack 500 Wh
SR Suntour XCR 34 LOR 120 mm	FSA CK-310 15T	Formula EHL-148S 12x148 mm	Bosch Charger 4 Ah
GHOST MTB Dia. 31.8 mm	Shimano CS-HG500-10 11-42	GHOST Light DC 1 31.6 mm	16012
GHOST Low Rizer MTB 740 mm Rise 25 mm Dia. 31.8 mm	Tektro HD-M285 2/2 Piston 203/180 mm Disc	Selle Italia X-Base	FRH60022
Shimano Deore RD-M6000 Shadow Plus 10-S	Schwalbe Smart Sam K-Guard 27.5x2.6 // Schwalbe Smart Sam K-Guard 27.5x2.6	Bosch Purion	S-M-L-XL
Rodi Tryp 584x30 mm 32H // Rodi Tryp 584x30 mm 32H	Bosch Performance CX		

SIZE	ARTICLENUMBER	NOTES
SIZE S	18YT1007	
SIZE M	18YT1008	
SIZE L	18YT1009	
SIZE XL	18YT1010	

























MODEL HIGHLIGHTS

- ▶ Bosch Performance CX motor
- ▶ Shimano Deore 10-speed drivetrain
- ▶ Custom contact points for women

MODELL HIGHLIGHTS

- ▶ Bosch Performance CX Motor
- ▶ Shimano Deore 10-fach Schaltung
- ▶ Frauenspezifische Kontaktpunkte

 Hybride TERU AL	 Shimano Deore SL-M6000	 Formula DC-511 15x110 mm	 Bosch Power Pack 500 Wh
 SR Suntour XCR 34 LOR 120 mm	 FSA CK-310 15T	 Formula EHL-148S 12x148 mm	 Bosch Charger 4 Ah
 GHOSH MTB Dia. 31.8 mm	 Shimano CS-HG500-10 11-42	 GHOSH Light DC 1 31.6 mm	 16012
 GHOSH Low Rizer MTB 740 mm Rise 25 mm Dia. 31.8 mm	 Tektro HD-M285 2/2 Piston 203/180 mm Disc	 Ergon SFC-30	 FRHG0022
 Shimano Deore RD-M6000 Shadow Plus 10-S	 Schwalbe Smart Sam K-Guard 27.5x2.6 // Schwalbe Smart Sam K-Guard 27.5x2.6	 Bosch Purion	 XS-S-M-L
 Rodri Tryp 584x30 mm 32H // Rodri Tryp 584x30 mm 32H		 Bosch Performance CX	

SIZE	ARTICLENUMBER	NOTES
SIZE XS	18Y13007	
SIZE S	18Y13008	
SIZE M	18Y13009	
SIZE L	18Y13010	



MODEL HIGHLIGHTS

- ▶ Bosch Performance CX motor
- ▶ Sturdy suspension fork catering higher demands
- ▶ Different color and wheel size option available

MODELL HIGHLIGHTS

- ▶ Bosch Performance CX Motor
- ▶ Steife Federgabel für höhere Belastungen
- ▶ Mit Farb- und Laufradoption

Hybride TERU AL	Shimano Deore SL-M6000	Formula DC-511 15x110 mm	Bosch Power Pack 500 Wh
SR Suntour XCR 34 LOR 120 mm	FSA CK-310 15T	Formula DC 22 QR	Bosch Charger 4 Ah
GHOSH MTB Dia. 31.8 mm	Shimano CS-HG500-10 11-42	GHOSH Light DC 1 31.6 mm	16012
GHOSH Low Rizer MTB 740 mm Rise 25 mm Dia. 31.8 mm	Tektro HD-M285 2/2 Piston 203/180 mm Disc	Selle Italia X-Base	EZ1954
Shimano Deore RD-M6000 Shadow Plus 10-S	Michelin Country Race R 29x2.10 // Michelin Country Race R 29x2.10	Bosch Purion	S-M-L-XL
Rodri Blackrock 622x21 mm 32H // Rodri Blackrock 622x21 mm 32H	Bosch Performance CX		

SIZE	ARTICLENUMBER	NOTES
SIZE S	18YT2001	
SIZE M	18YT2002	
SIZE L	18YT2003	
SIZE XL	18YT2004	



MODEL HIGHLIGHTS

- ▶ Bosch Performance CX motor
- ▶ Sturdy suspension fork catering higher demands
- ▶ Different color and wheel size option available

MODELL HIGHLIGHTS

- ▶ Bosch Performance CX Motor
- ▶ Steife Federgabel für höhere Belastungen
- ▶ Mit Farb- und Laufradoption

Hybride TERU AL	Shimano Deore SL-M6000	Formula DC-511 15x110 mm	Bosch Power Pack 500 Wh
SR Suntour XCR 34 LOR 120 mm	FSA CK-310 15T	Formula DC 22 QR	Bosch Charger 4 Ah
GHOST MTB Dia. 31.8 mm	Shimano CS-HG500-10 11-42	GHOST Light DC 1 31.6 mm	16012
GHOST Low Rizer MTB 740 mm Rise 25 mm Dia. 31.8 mm	Tektro HD-M285 2/2 Piston 203/180 mm Disc	Selle Italia X-Base	E21954
Shimano Deore RD-M6000 Shadow Plus 10-S	Michelin Country Race R 29x2.10 // Michelin Country Race R 29x2.10	Bosch Purion	S-M-L-XL
-	Rodi Blackrock 622x21 mm 32H // Rodi Blackrock 622x21 mm 32H	Bosch Performance CX	

SIZE	ARTICLENUMBER	NOTES
SIZE S	18Y12007	
SIZE M	18Y12008	
SIZE L	18Y12009	
SIZE XL	18Y12010	



// TOUR / TOUR

FEATURES



CHARACTERISTICS

- ▶ 500 Wh integrated battery, motor with up to 75 Nm torque
- ▶ Carrier and fender mounting points

CHARAKTERISTIK

- ▶ 500 Wh Akku, Motor mit bis zu 75 Nm Drehmoment
- ▶ Gepäckträger- und Schutzblechaufnahmen

TARGET GROUP

- ▶ Attractively priced E-mountain bike, ideal for beginners

ZIELGRUPPE

- ▶ Preisgünstiges E-Mountainbike speziell für Einsteiger



// GEOMETRY AND DATA CHARTS / GEOMETRIE UND TECHNISCHE DATEN

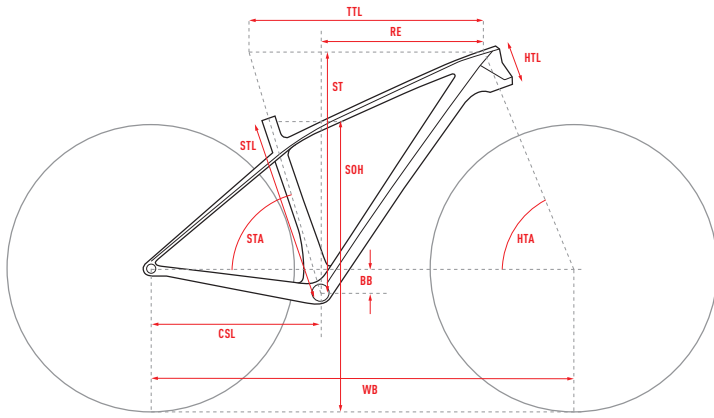

ALL DIMENSIONS IN MM (EXCEPT HTA AND STA IN °)

ALLE MASSE IN MM (AUSNAHME HTA UND STA IN °)

- STL** SEAT TUBE LENGTH
SITZROHRLÄNGE
- CSL** CHAINSTAY LENGTH
KETTENSTREBENLÄNGE
- TTL** TOP TUBE LENGTH
OBERROHRLÄNGE
- HTL** HEADTUBE LENGTH
STEUERROHRLÄNGE
- HTA** HEADTUBE ANGLE
STEUERROHRWINKEL
- STA** SEATTUBE ANGLE
SITZROHRWINKEL
- BB** BB DROP
TRETLAGERABSENKUNG
- WB** WHEELBASE
RADSTAND
- ST** STACK
STACK
- RE** REACH
REACH
- SOH** STANDOVER HEIGHT
ÜBERSTANDSHÖHE
- HEAD SET DIAMETER (UPPER / LOWER)**
STEUERSATZDURCHMESSER (OBEN / UNTEN)
- AXLE STANDARD (REAR / FRONT)**
ACHSENSTANDARD (HINTEN / VORNE)
- BOTTOM BRACKET STANDARD**
TRETLAGERSTANDARD
- SEAT POST DIAMETER**
SITZSTÜTZENDURCHMESSER
- SHOCK HARDWARE (Ø 8MM)**
DÄMPFERBUCHSENMASSE (Ø 8MM)
- SHOCK LENGTH**
DÄMPFEREINBAULÄNGE
- SHOCK TRAVEL**
DÄMPFERHUB
- FRONT FORK TRAVEL**
FEDERWEG VORNE
- REAR WHEEL TRAVEL**
FEDERWEG HINTEN
- MIN SADDLE HEIGHT**
MIN SITZTELHÖHE
- MAX SADDLE HEIGHT**
MAX SITZTELHÖHE
- MIN INSEAM**
MIN SCHRITTLÄNGE
- MAX INSEAM**
MAX SCHRITTLÄNGE
- STEM LENGTH**
VORBAULÄNGE
- HANDLEBAR WIDTH**
LENKERBREITE
- CRANK LENGTH**
KURBELLÄNGE
- SEAT TUBE BOTTLE MOUNT**
FLASCHE SATTELROHR
- DOWN TUBE BOTTLE MOUNT**
FLASCHE UNTERROHR

STL CSL TTL HTL HTA STA BB WB ST RE SOH ST DT

HYBRIDE TERU B3.7 AL U

	STL	CSL	TTL	HTL	HTA	STA	BB	WB	ST	RE	SOH																		
S	420	465	585	110	68	73	41	1136	600	400	698	ZS44/ZS56	135/100	/	31.6	/	/	/	120	/	75	720	175	/	/				
M	460	465	600	120	68	73	41	1152	610	412.5	733	ZS44/ZS56	135/100	/	31.6	/	/	/	120	/	90	720	175	/	/				
L	500	465	620	130	68	73	41	1172.5	620	430	765	ZS44/ZS56	135/100	/	31.6	/	/	/	120	/	105	720	175	/	/				



SHINY // microchip gray / night black / riot red

TERU SPECIAL B3.7
HYBRIDE



MODEL HIGHLIGHTS

- ▶ Bosch Performance CX motor
- ▶ 27" wheels for playful handling
- ▶ The beginners' choice

MODELL HIGHLIGHTS

- ▶ Bosch Performance CX Motor
- ▶ 27" Bereifung für agile Handhabung
- ▶ Ideal für Einsteiger

Hybride TERU AL	Shimano Deore SL-M590	Shimano HB-TX505 OR	Bosch Power Pack 500 Wh
SR Suntour SF 15 XCM-DS-27,5 120 mm	Miranda Delta 15T	Shimano FH-RM33 OR	Bosch Charger 2 Ah
GHOST MTB Dia. 31.8 mm	Shimano CS-HG300-9 12-36	GHOST SP-719 31.6 mm	16012
GHOST Low Rizer MTB 720 mm Rise 10 mm Dia. 31.8 mm	Shimano BR-M315 2/2 Piston 180 mm	GHOST VLI353	E21954
Shimano Deore RD-M592 9-S Shadow Design	Schwalbe Smart Sam 2.25 // Schwalbe Smart Sam 2.25	Bosch Purion	S-M-L
Rodri Blackrock 584x21 mm 32H // Rodri Blackrock 584x21 mm 32H	Bosch Performance CX		

SIZE	ARTICLENUMBER	NOTES
SIZE S	18HY5900	
SIZE M	18HY5901	
SIZE L	18HY5902	

⚡ **SQUARE**^{CROSS}



// CROSS / FITNESS

FEATURES



CHARACTERISTICS

- ▶ 500 Wh battery with 4 Ah charger
- ▶ 29" components for a sporty and safe ride similar to a mountainbike
- ▶ Athletic, new looks and equipment

CHARAKTERISTIK

- ▶ 500 Wh Akku mit 4 Ah Ladegerät
- ▶ 29" Komponenten für sicheres und sportliches Fahren wie beim Mountainbike
- ▶ Sportive, neue Optik und Ausstattung

TARGET GROUP

- ▶ Bikers that need a comfortable E-bike adapting well to all types of terrain

ZIELGRUPPE

- ▶ Fahrer, die ein komfortables, universelles E-Bike suchen, das sich auf allen Strecken wohlfühlt



// GEOMETRY AND DATA CHARTS / GEOMETRIE UND TECHNISCHE DATEN

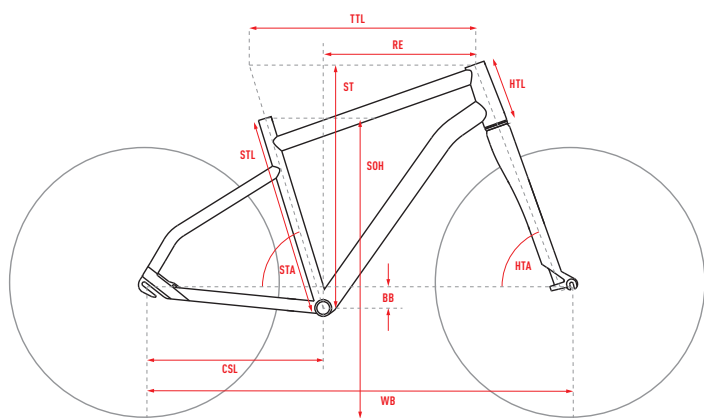

ALL DIMENSIONS IN MM (EXCEPT HTA AND STA IN °)

ALLE MASSE IN MM (AUSNAHME HTA UND STA IN °)

- STL** SEAT TUBE LENGTH
SITZROHRLÄNGE
- CSL** CHAINSTAY LENGTH
KETTENSTREBENLÄNGE
- TTL** TOP TUBE LENGTH
OBERROHRLÄNGE
- HTL** HEADTUBE LENGTH
STEUERROHRLÄNGE
- HTA** HEADTUBE ANGLE
STEUERROHRWINKEL
- STA** SEATTUBE ANGLE
SITZROHRWINKEL
- BB** BB DROP
TRETLAGERABSSENKUNG
- WB** WHEELBASE
RADSTAND
- ST** STACK
STACK
- RE** REACH
REACH
- SOH** STANDOVER HEIGHT
ÜBERSTANDSHÖHE
- HEAD SET DIAMETER (UPPER / LOWER)
STEUERSATZDURCHMESSER (OBEN / UNTEN)
- AXLE STANDARD (REAR / FRONT)
ACHSENSTANDARD (HINTEN / VORNE)
- BOTTOM BRACKET STANDARD
TRETLAGERSTANDARD
- SEAT POST DIAMETER
SITZSTÜTZENDURCHMESSER
- SHOCK HARDWARE (Ø 8MM)
DÄMPFERBUCHSENMASSE (Ø 8MM)
- SHOCK LENGTH
DÄMPFEREINBAULÄNGE
- SHOCK TRAVEL
DÄMPFERHUB
- FRONT FORK TRAVEL
FEDERWEG VORNE
- REAR WHEEL TRAVEL
FEDERWEG HINTEN
- MIN SADDLE HEIGHT
MIN SITZELHÖHE
- MAX SADDLE HEIGHT
MAX SITZELHÖHE
- MIN INSEAM
MIN SCHRITTLÄNGE
- MAX INSEAM
MAX SCHRITTLÄNGE
- STEM LENGTH
VORBAULÄNGE
- HANDLEBAR WIDTH
LENKERBREITE
- CRANK LENGTH
KURBELLENGE
- SEATTUBE BOTTLE MOUNT
FLASCHE SATTELROHR
- DOWNTUBE BOTTLE MOUNT
FLASCHE UNTERROHR

STL CSL TTL HTL HTA STA BB WB ST RE SOH

HYBRIDE SQUARE CROSS B4.9 / B2.9 AL U

	STL	CSL	TTL	HTL	HTA	STA	BB	WB	ST	RE	SOH																			
S	470	470	580	160	70	73.5	60	1120	636	391	735	ZS44/ZS56	135/100	/	31.6	/	/	/	60	/	80	680	170	0.75	/					
M	520	470	595	165	70	72.5	60	1123	641	393	770	ZS44/ZS56	135/100	/	31.6	/	/	/	60	/	80	680	170	0.75	/					
L	570	470	610	185	71	72.5	60	1127	664	400	815	ZS44/ZS56	135/100	/	31.6	/	/	/	60	/	80	680	170	0.75	/					
XL	620	470	625	205	71	72	60	1136	683	403	855	ZS44/ZS56	135/100	/	31.6	/	/	/	60	/	80	680	170	0.75	/					

HYBRIDE SQUARE CROSS B4.9 / B2.9 AL W

	STL	CSL	TTL	HTL	HTA	STA	BB	WB	ST	RE	SOH																			
XS	420	470	560	150	70.5	73	60	1088	629	368	630	ZS44/ZS56	135/100	/	31.6	/	/	/	60	/	80	680	170	/	/					
S	470	470	575	155	70.5	72	60	1091	634	369	625	ZS44/ZS56	135/100	/	31.6	/	/	/	60	/	80	680	170	/	/					
M	520	470	590	170	70.5	72	60	1106	648	379	625	ZS44/ZS56	135/100	/	31.6	/	/	/	60	/	80	680	170	/	/					
L	560	470	610	185	70.5	72	60	1127	662	395	625	ZS44/ZS56	135/100	/	31.6	/	/	/	60	/	80	680	170	/	/					



MODEL HIGHLIGHTS

- ▶ Powerful Bosch Performance CX motor
- ▶ Equipped with air suspension fork
- ▶ Shimano XT rear derailleur

MODELL HIGHLIGHTS

- ▶ Starker Bosch Performance CX Motor
- ▶ Mit Luftfedergabel
- ▶ Shimano XT Schaltwerk

Hybride SQUARE Cross AL	Shimano SLX SL-M7000	Formula DC 20 QR	Bosch Power Pack 500 Wh
RST Viv Air TNL 60 mm	FSA CK-310 15T	Formula DC 22 QR	Bosch Charger 4 Ah
Satori HL STEALTH 6 Dia. 31.8 mm	Sunrace MS8-E 11-46	Satori HL Comet 31.6 mm	16012
Satori Deviant Bow 680 mm Rise 12 mm Dia. 31.8 mm	Tektro HD-M285 2/2 Piston 180 mm Disc	Justek 3050 HRN	EZ1954
Shimano XT RD-M8000 Shadow Plus 11-S	Schwalbe Smart Sam Dual Compund 29x2.10 // Schwalbe Smart Sam Dual Compund 29x2.10	Bosch Intuvia	S-M-L-XL
Rodri Excalibur XC 622x19 mm 32H // Rodri Excalibur XC 622x19 mm 32H	Bosch Performance CX		

SIZE	ARTICLENUMBER	NOTES
SIZE S	18YS5013	
SIZE M	18YS5014	
SIZE L	18YS5015	
SIZE XL	18YS5016	

























MODEL HIGHLIGHTS

- ▶ Powerful Bosch Performance CX motor
- ▶ Equipped with air suspension fork
- ▶ Shimano XT rear derailleur

MODELL HIGHLIGHTS

- ▶ Starker Bosch Performance CX Motor
- ▶ Mit Luftfedergabel
- ▶ Shimano XT Schaltwerk

 Hybride SQUARE Cross AL	 Shimano SLX SL-M7000	 Formula DC 20 QR	 Bosch Power Pack 500 Wh
 RST Viv Air TNL 60 mm	 FSA CK-310 15T	 Formula DC 22 QR	 Bosch Charger 4 Ah
 Satori HL STEALTH 6 Dia. 31.8 mm	 Sunrace MS8-E 11-46	 Satori HL Comet 31.6 mm	 16012
 Satori Deviant Bow 680 mm Rise 12 mm Dia. 31.8 mm	 Tektro HD-M285 2/2 Piston 180 mm Disc	 Justek 3050 DRN	 EZ1954
 Shimano XT RD-M8000 Shadow Plus 11-S	 Schwalbe Smart Sam Dual Compound 29x2.10 // Schwalbe Smart Sam Dual Compound 29x2.10	 Bosch Intuvia	 XS-S-M-L
 Rodi Excalibur XC 622x19 mm 32H // Rodi Excalibur XC 622x19 mm 32H	 Bosch Performance CX		

SIZE	ARTICLENUMBER	NOTES
SIZE XS	18YS6013	
SIZE S	18YS6014	
SIZE M	18YS6015	
SIZE L	18YS6016	



FLAT // urban gray / night black / neon yellow

SQUARE^{CROSS} B2.9



MODEL HIGHLIGHTS

- ▶ Performance motor with 500 Wh battery
- ▶ 29" for a more athletic riding style
- ▶ Color option available

MODELL HIGHLIGHTS

- ▶ Performance Motor mit 500 Wh Batterie
- ▶ 29" für sportlicheres Fahren
- ▶ Mit Farboption

Hybride SQUARE Cross AL	Shimano Altus SL-M2000	Formula DC 20 QR	Bosch Power Pack 500 Wh
RST Nova MLO 60 mm	FSA CK-310 15T	Formula DC 22 QR	Bosch Charger 4 Ah
GHOST SQUARE Dia. 31.8 mm	Shimano CS-HG-200-9 11-36	GHOST SP-DC1 31.6 mm	16012
GHOST Low Rizer 680 mm Rise 15 mm Dia. 31.8 mm	Tektro HD-M285 2/2 Piston 180 mm Disc	Justek 3050 HRN	EZ1954
Shimano Altus RD-M2000 9-S Shadow Design	Impac Ridgepac 29x2.10 // Impac Ridgepac 29x2.10	Bosch Purion	S-M-L-XL
Rodri Excalibur XC 622x19 mm 32H // Rodri Excalibur XC 622x19 mm 32H	Bosch Performance Cruise		

SIZE	ARTICLENUMBER	NOTES
SIZE S	18YS001	
SIZE M	18YS002	
SIZE L	18YS003	
SIZE XL	18YS004	

























MODEL HIGHLIGHTS

- ▶ Performance motor with 500 Wh battery
- ▶ 29" for a more athletic riding style
- ▶ Color option available

MODELL HIGHLIGHTS

- ▶ Performance Motor mit 500 Wh Batterie
- ▶ 29" für sportlicheres Fahren
- ▶ Mit Farboption

 Hybride SQUARE Cross AL	 Shimano Altus SL-M2000	 Formula DC 20 QR	 Bosch Power Pack 500 Wh
 RST Nova MLO 60 mm	 FSA CK-310 15T	 Formula DC 22 QR	 Bosch Charger 4 Ah
 GHOST SQUARE Dia. 31.8 mm	 Shimano CS-HG-200-9 11-36	 GHOST SP-DC1 31.6 mm	 16012
 GHOST Low Rizer 680 mm Rise 15 mm Dia. 31.8 mm	 Tektro HD-M285 2/2 Piston 180 mm Disc	 Justek 3050 DRN	 E21954
 Shimano Altus RD-M2000 9-S Shadow Design	 Impac Ridgepac 29x2.10 // Impac Ridgepac 29x2.10	 Bosch Purion	 XS-S-M-L
 -	 Rodi Excalibur XC 622x19 mm 32H // Rodi Excalibur XC 622x19 mm 32H	 Bosch Performance Cruise	

SIZE	ARTICLENUMBER	NOTES
SIZE XS	18YS6001	
SIZE S	18YS6002	
SIZE M	18YS6003	
SIZE L	18YS6004	



FLAT // star white / night black / vibrant blue

SQUARE^{CROSS} B2.9



MODEL HIGHLIGHTS

- ▶ Performance motor with 500 Wh battery
- ▶ 29" for a more athletic riding style
- ▶ Color option available

MODELL HIGHLIGHTS

- ▶ Performance Motor mit 500 Wh Batterie
- ▶ 29" für sportlicheres Fahren
- ▶ Mit Farboption

Hybride SQUARE Cross AL	Shimano Altus SL-M2000	Formula DC 20 QR	Bosch Power Pack 500 Wh
RST Nova MLO 60 mm	FSA CK-310 15T	Formula DC 22 QR	Bosch Charger 4 Ah
GHOST SQUARE Dia. 31.8 mm	Shimano CS-HG-200-9 11-36	GHOST SP-DC1 31.6 mm	16012
GHOST Low Rizer 680 mm Rise 15 mm Dia. 31.8 mm	Tektro HD-M285 2/2 Piston 180 mm Disc	Justek 3050 HRN	E21954
Shimano Altus RD-M2000 9-S Shadow Design	Impac Ridgepac 29x2.10 // Impac Ridgepac 29x2.10	Bosch Purion	S-M-L-XL
Rodri Excalibur XC 622x19 mm 32H // Rodri Excalibur XC 622x19 mm 32H	Bosch Performance Cruise		

SIZE	ARTICLENUMBER	NOTES
SIZE S	18YS5007	
SIZE M	18YS5008	
SIZE L	18YS5009	
SIZE XL	18YS5010	

























MODEL HIGHLIGHTS

- ▶ Performance motor with 500 Wh battery
- ▶ 29" for a more athletic riding style
- ▶ Color option available

MODELL HIGHLIGHTS

- ▶ Performance Motor mit 500 Wh Batterie
- ▶ 29" für sportlicheres Fahren
- ▶ Mit Farboption

 Hybride SQUARE Cross AL	 Shimano Altus SL-M2000	 Formula DC 20 QR	 Bosch Power Pack 500 Wh
 RST Nova MLO 60 mm	 FSA CK-310 15T	 Formula DC 22 QR	 Bosch Charger 4 Ah
 GHOST SQUARE Dia. 31.8 mm	 Shimano CS-HG-200-9 11-36	 GHOST SP-DC1 31.6 mm	 16012
 GHOST Low Rizer 680 mm Rise 15 mm Dia. 31.8 mm	 Tektro HD-M285 2/2 Piston 180 mm Disc	 Justek 3050 DRN	 E21954
 Shimano Altus RD-M2000 9-S Shadow Design	 Impac Ridgepac 29x2.10 // Impac Ridgepac 29x2.10	 Bosch Purion	 XS-S-M-L
 -	 Rodi Excalibur XC 622x19 mm 32H // Rodi Excalibur XC 622x19 mm 32H	 Bosch Performance Cruise	

SIZE	ARTICLENUMBER	NOTES
SIZE XS	18YS6007	
SIZE S	18YS6008	
SIZE M	18YS6009	
SIZE L	18YS6010	



// TREKKING / LEISURE

FEATURES



CHARACTERISTICS

- ▶ 500 Wh battery with 4 Ah charger
- ▶ Modern looks with subtle colors
- ▶ New: completely reworked carrier

CHARAKTERISTIK

- ▶ 500 Wh Akku mit 4 Ah Ladegerät
- ▶ Modernere Optik mit dezenten Farben
- ▶ Neu: komplett überarbeiteter Gepäckträger

TARGET GROUP

- ▶ Comfort-oriented trekking riders with a sense of appreciation for design

ZIELGRUPPE

- ▶ Komfortorientierte Trekkingfahrer mit Sinn für Design

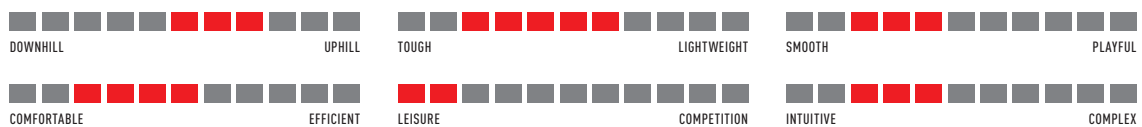



MODEL HIGHLIGHTS

- ▶ Powerful Bosch Performance CX motor
- ▶ High-end Bosch Nyon display
- ▶ Magura MT Thirty2 4/2-piston brake for safe stopping

MODELL HIGHLIGHTS

- ▶ Starker Bosch Performance CX Motor
- ▶ Hochwertiges Bosch Nyon Display
- ▶ Magura MT Thirty2 4/2-Kolbenbremse: sicher bremsen

Hybride SQUARE Trekking AL	FSA CK-310 15T	Satori Sorata Fury 31.6 mm	Bosch Nyon
SR Suntour Mobie 45 LOR DS Air 60 mm	Shimano SLX CS-M7000 11-42	Justek 3050 HRN	Bosch Performance CX
Satori HL STEALTH 6 Dia. 31.8 mm	Magura MT Thirty2 4/2 Piston 203/180 mm Disc	GHOST SQUARE Trekking Carrier	Bosch Power Pack 500 Wh
Satori Deviant Bow 680 mm Rise 12 mm Dia. 31.8 mm	Continental Contact Cruiser 50-622 // Continental Contact Cruiser 50-622	GHOST RG50	Bosch Charger 4 Ah
Shimano XT RD-M8000 Shadow Plus 11-S	Rudi Blackrock 622x21 mm 32H // Rudi Blackrock 622x21 mm 32H	Pletscher	16012
-	Formula DC-51 15 x 100 mm	Supernova E3 E-Bike V6s 6 V DC	EZ1954
Shimano XT SL-M8000	Formula DC 22 QR	Supernova Tail Light	S-M-L-XL

SIZE	ARTICLENUMBER	NOTES
SIZE S	18YS3007	
SIZE M	18YS3008	
SIZE L	18YS3009	
SIZE XL	18YS3010	































MODEL HIGHLIGHTS

- ▶ Powerful Bosch Performance CX motor
- ▶ High-end Bosch Nyon display
- ▶ Magura MT Thirty2 4/2-piston brake for safe stopping

MODELL HIGHLIGHTS

- ▶ Starker Bosch Performance CX Motor
- ▶ Hochwertiges Bosch NYON Display
- ▶ Magura MT Thirty2 4/2-Kolbenbremse: sicher bremsen

 Hybride SQUARE Trekking AL	 FSA CK-310 15T	 Satori Sorata Fury 31.6 mm	 Bosch Nyon
 SR Suntour Mobie 45 LOR DS Air 60 mm	 Shimano SLX CS-M7000 11-42	 Justek 3050 DRN	 Bosch Performance CX
 Satori HL STEALTH 6 Dia. 31.8 mm	 Magura MT Thirty2 4/2 Piston 203/180 mm Disc	 GHOST SQUARE Trekking Carrier	 Bosch Power Pack 500 Wh
 Satori Deviant Bow 680 mm Rise 12 mm Dia. 31.8 mm	 Continental Contact Cruiser 50-622 // Continental Contact Cruiser 50-622	 GHOST R650	 Bosch Charger 4 Ah
 Shimano XT RD-M8000 Shadow Plus 11-S	 Rodi Blackrock 622x21 mm 32H // Rodi Blackrock 622x21 mm 32H	 Pletscher	 16012
 -	 Formula DC-51 15 x 100 mm	 Supernova E3 E-Bike V6s 6 V DC	 EZ1954
 Shimano XT SL-M8000	 Formula DC 22 QR	 Supernova Tail Light	 XS-S-M-L

SIZE	ARTICLENUMBER	NOTES
SIZE XS	18YS4007	
SIZE S	18YS4008	
SIZE M	18YS4009	
SIZE L	18YS4010	



FLAT // classic green / night black / palladium silver

SQUARE TREKKING B6.8



MODEL HIGHLIGHTS

- ▶ GHOST SQUARE rigid fork
- ▶ SRAM GX1 1x11 drivetrain
- ▶ Magura MT Thirty2 4/2-piston brake for safe stopping

MODELL HIGHLIGHTS

- ▶ GHOST SQUARE Starrgabel
- ▶ SRAM GX1 1x11-Antrieb
- ▶ Magura MT Thirty2 4/2-Kolbenbremse: sicher bremsen

Hybride SQUARE Trekking AL	FSA CK-200 40T	Satori Sorata Fury 31.6 mm	Bosch Intuvia
GHOST AL Rigid	SRAM PG-1130 11-42	Justek 3050 HRN	Bosch Active Line Plus
Satori HL STEALTH 6 Dia. 31.8 mm	Magura MT Thirty2 4/2 Piston 180 mm Disc	GHOST SQUARE Trekking Carrier	Bosch Power Pack 500 Wh
Satori Deviant Bow 680 mm Rise 12 mm Dia. 31.8 mm	Continental Contact Cruiser 50-622 // Continental Contact Cruiser 50-622	GHOST RG50	Bosch Charger 4 Ah
SRAM GX1 11-S	Rudi Blackrock 622x21 mm 32H // Rudi Blackrock 622x21 mm 32H	Pletscher	16012
-	Formula DC 20 QR	Supernova V521S E-Bike 5-21V DC	EZ1954
SRAM NX	Formula DC 22 QR	Supernova Tail Light	S-M-L-XL

SIZE	ARTICLENUMBER	NOTES
SIZE S	18YS1019	
SIZE M	18YS1020	
SIZE L	18YS1021	
SIZE XL	18YS1022	



MODEL HIGHLIGHTS

- ▶ GHOST SQUARE rigid fork
- ▶ SRAM GX1 1x11 drivetrain
- ▶ Magura MT Thirty2 4/2-piston brake for safe stopping
- ▶ Supernova lights

MODELL HIGHLIGHTS

- ▶ GHOST SQUARE Starrgabel
- ▶ SRAM GX1 1x11-Antrieb
- ▶ Magura MT Thirty2 4/2-Kolbenbremse: sicher bremsen
- ▶ Supernova Beleuchtung

Hybride SQUARE Trekking AL	FSA CK-200 40T	Satori Sorata Fury 31.6 mm	Bosch Intuvia
GHOST AL Rigid	SRAM PG-1130 11-42	Justek 3050 DRN	Bosch Active Line Plus
Satori HL STEALTH 6 Dia. 31.8 mm	Magura MT Thirty2 4/2 Piston 180 mm Disc	GHOST SQUARE Trekking Carrier	Bosch Power Pack 500 Wh
Satori Deviant Bow 680 mm Rise 12 mm Dia. 31.8 mm	Continental Contact Cruiser 50-622 // Continental Contact Cruiser 50-622	GHOST R650	Bosch Charger 4 Ah
SRAM GX1 11-S	Rodi Blackrock 622x21 mm 32H // Rodi Blackrock 622x21 mm 32H	Pletscher	16012
-	Formula DC 20 QR	Supernova V521S E-Bike 5-21V DC	EZ1954
SRAM NX	Formula DC 22 QR	Supernova Tail Light	XS-S-M-L

SIZE	ARTICLENUMBER	NOTES
SIZE XS	18YS0019	
SIZE S	18YS0020	
SIZE M	18YS0021	
SIZE L	18YS0022	



FLAT // paltadium silver / night black



MODEL HIGHLIGHTS

- ▶ Bosch Performance Cruise motor
- ▶ Lightweight air spring fork
- ▶ Shimano Deore 10-speed rear derailleur

MODELL HIGHLIGHTS

- ▶ Bosch Performance Cruise Motor
- ▶ Leichte Luftfedergabel
- ▶ Shimano Deore 10-fach Schaltwerk

Hybride SQUARE Trekking AL	FSA CK-310 15T	Satori Sorata Fury 31.6 mm	Bosch Intuvia
RST Viv Air TNL 60 mm	Shimano CS-HG500-10 11-42	Justek 3050 HRN	Bosch Performance Cruise
Satori HL STEALTH 6 Dia. 31.8 mm	Tektro HD-T 285 2/2 Piston 180 mm Disc	GHOST SQUARE Trekking Carrier	Bosch Power Pack 500 Wh
Satori Deviant Bow 680 mm Rise 12 mm Dia. 31.8 mm	Continental Contact Cruiser 50-622 // Continental Contact Cruiser 50-622	GHOST RG50	Bosch Charger 4 Ah
Shimano Deore RD-M6000 Shadow Plus 10-S	Rudi Blackrock 622x21 mm 32H // Rudi Blackrock 622x21 mm 32H	Pletscher	16012
-	Formula DC 20 QR	Busch & Müller Lumotec Avy DC 12 V	EZ1954
Shimano Deore SL-M6000	Formula DC 22 QR	Busch & Müller Toplight View DC 5 - 15 V	S-M-L-XL

SIZE	ARTICLENUMBER	NOTES
SIZE S	18YS3001	
SIZE M	18YS3002	
SIZE L	18YS3003	
SIZE XL	18YS3004	



MODEL HIGHLIGHTS

- ▶ Bosch Performance Cruise motor
- ▶ Lightweight air spring fork
- ▶ Shimano Deore 10-speed rear derailleur

MODELL HIGHLIGHTS

- ▶ Bosch Performance Cruise Motor
- ▶ Leichte Luftfedergabel
- ▶ Shimano Deore 10-fach Schaltwerk

Hybride SQUARE Trekking AL	FSA CK-310 15T	Satori Sorata Fury 31.6 mm	Bosch Intuvia
RST Viv Air TNL 60 mm	Shimano CS-HG500-10 11-42	Justek 3050 DRN	Bosch Performance Cruise
Satori HL STEALTH 6 Dia. 31.8 mm	Tektro HD-T 285 2/2 Piston 180 mm Disc	GHOST SQUARE Trekking Carrier	Bosch Power Pack 500 Wh
Satori Deviant Bow 680 mm Rise 12 mm Dia. 31.8 mm	Continental Contact Cruiser 50-622 // Continental Contact Cruiser 50-622	GHOST R650	Bosch Charger 4 Ah
Shimano Deore RD-M6000 Shadow Plus 10-S	Rodi Blackrock 622x21 mm 32H // Rodi Blackrock 622x21 mm 32H	Pletscher	16012
-	Formula DC 20 QR	Busch & Müller Lumotec Avy DC 12 V	EZ1954
Shimano Deore SL-M6000	Formula DC 22 QR	Busch & Müller Toplight View DC 5 - 15 V	XS-S-M-L

SIZE	ARTICLENUMBER	NOTES
SIZE XS	18YS4001	
SIZE S	18YS4002	
SIZE M	18YS4003	
SIZE L	18YS4004	



FLAT // classic red / night black / palladium silver



SQUARE TREKKING B4.8



MODEL HIGHLIGHTS

- ▶ Powerful lighting system by Busch & Müller
- ▶ Shimano Deore 10-speed rear derailleur
- ▶ New Bosch Active plus motor

MODELL HIGHLIGHTS

- ▶ Starke Busch & Müller Beleuchtung
- ▶ Shimano Deore 10-fach Schaltwerk
- ▶ Neuer Bosch Active plus Motor

Hybride SQUARE Trekking AL	FSA CK-200 40T	Satori HL Comet 31,6 mm	Bosch Intuvia
RST Viv Air TNL 60 mm	Shimano CS-HG500-10 11-42	Justek 3050 HRN	Bosch Active Line Plus
Satori HL STEALTH 6 Dia. 31.8 mm	Tektro HD-T 285 2/2 Piston 180 mm Disc	GHOST SQUARE Trekking Carrier	Bosch Power Pack 500 Wh
Satori Deviant Bow 680 mm Rise 12 mm Dia. 31.8 mm	Continental Contact Cruiser 50-622 // Continental Contact Cruiser 50-622	GHOST RG50	Bosch Charger 4 Ah
Shimano Deore RD-M6000 Shadow Plus 10-S	Rudi Blackrock 622x21 mm 32H // Rudi Blackrock 622x21 mm 32H	Pletscher	16012
-	Formula DC 20 QR	Busch & Müller Lumotec Avy DC 12 V	EZ1954
Shimano Deore SL-M6000	Formula DC 22 QR	Busch & Müller Toplight View DC 5 - 15 V	S-M-L-XL

SIZE	ARTICLENUMBER	NOTES
SIZE S	18YS1013	
SIZE M	18YS1014	
SIZE L	18YS1015	
SIZE XL	18YS1016	



MODEL HIGHLIGHTS

- ▶ Lightweight air spring fork
- ▶ Shimano Deore 10-speed rear derailleurs
- ▶ New Bosch Active plus motor

MODELL HIGHLIGHTS

- ▶ Leichte Luftfedergabel
- ▶ Shimano Deore 10-fach Schaltwerk
- ▶ Neuer Bosch Active plus Motor

Hybride SQUARE Trekking AL	FSA CK-200 40T	Satori HL Comet 31.6 mm	Bosch Intuvia
RST Viv Air TNL 60 mm	Shimano CS-HG500-10 11-42	Justek 3050 DRN	Bosch Active Line Plus
Satori HL STEALTH 6 Dia. 31.8 mm	Tektro HD-T 285 2/2 Piston 180 mm Disc	GHOST SQUARE Trekking Carrier	Bosch Power Pack 500 Wh
Satori Deviant Bow 680 mm Rise 12 mm Dia. 31.8 mm	Continental Contact Cruiser 50-622 // Continental Contact Cruiser 50-622	GHOST R650	Bosch Charger 4 Ah
Shimano Deore RD-M6000 Shadow Plus 10-S	Rodi Blackrock 622x21 mm 32H // Rodi Blackrock 622x21 mm 32H	Pletscher	16012
-	Formula DC 20 QR	Busch & Müller Lumotec Avy DC 12 V	EZ1954
Shimano Deore SL-M6000	Formula DC 22 QR	Busch & Müller Toplight View DC 5 - 15 V	XS-S-M-L

SIZE	ARTICLENUMBER	NOTES
SIZE XS	18YS0013	
SIZE S	18YS0014	
SIZE M	18YS0015	
SIZE L	18YS0016	



FLAT // titanium gray / night black / palladium silver

 **SQUARE** TREKKING B3.8































MODEL HIGHLIGHTS

- ▶ Bosch Active Line Plus motor
- ▶ 500 Wh battery pack for longer rides
- ▶ Continental Contact Cruiser trekking specific tires

MODELL HIGHLIGHTS

- ▶ Bosch Active Line Plus Motor
- ▶ 500 Wh Akku für größere Reichweite
- ▶ Continental Contact Cruiser Trekking-Bereifung

 Hybride SQUARE Trekking AL	 FSA CK-200 40T	 GHOST SP-DC1 31.6 mm	 Bosch Intuvia
 RST Nova MLO 60 mm	 Shimano CS-HG-200-9 11-36	 Justek 3050 HRN	 Bosch Active Line Plus
 GHOST SQUARE Dia. 31.8 mm	 Tektro HD-T 285 2/2 Piston 180 mm Disc	 GHOST SQUARE Trekking Carrier	 Bosch Power Pack 500 Wh
 GHOST Low Rizer 680 mm Rise 15 mm Dia. 31.8 mm	 Continental Contact Cruiser 50-622 // Continental Contact Cruiser 50-622	 GHOST RG50	 Bosch Charger 4 Ah
 Shimano XT RD-M772 9-S Shadow Profile	 Rudi Blackrock 622x21 mm 32H // Rudi Blackrock 622x21 mm 32H	 Pletscher	 16012
 -	 Formula DC 20 QR	 Busch & Müller Lumotec Lyt B DC 12V	 EZ1954
 Shimano Altus SL-M2000	 Formula DC 22 QR	 Busch & Müller Toplight View DC 5 - 15 V	 S-M-L-XL

SIZE	ARTICLENUMBER	NOTES
SIZE S	18YS1007	
SIZE M	18YS1008	
SIZE L	18YS1009	
SIZE XL	18YS1010	



MODEL HIGHLIGHTS

- ▶ Bosch Active Line Plus motor
- ▶ 500 Wh battery pack for longer rides
- ▶ Continental Contact Cruiser trekking specific tires

MODELL HIGHLIGHTS

- ▶ Bosch Active Line Plus Motor
- ▶ 500 Wh Akku für größere Reichweite
- ▶ Continental Contact Cruiser Trekking-Bereifung

Hybride SQUARE Trekking AL	FSA CK-200 40T	GHOST SP-DC1 31.6 mm	Bosch Intuvia
RST Nova MLO 60 mm	Shimano CS-HG-200-9 11-36	Justek 3050 DRN	Bosch Active Line Plus
GHOST SQUARE Dia. 31.8 mm	Tektro HD-T 285 2/2 Piston 180 mm Disc	GHOST SQUARE Trekking Carrier	Bosch Power Pack 500 Wh
GHOST Low Rizer 680 mm Rise 15 mm Dia. 31.8 mm	Continental Contact Cruiser 50-622 // Continental Contact Cruiser 50-622	GHOST R650	Bosch Charger 4 Ah
Shimano XT RD-M772 9-S Shadow Profile	Rodi Blackrock 622x21 mm 32H // Rodi Blackrock 622x21 mm 32H	Pletscher	16012
-	Formula DC 20 QR	Busch & Müller Lumotec Lyt B DC 12V	EZ1954
Shimano Altus SL-M2000	Formula DC 22 QR	Busch & Müller Toplight View DC 5 - 15 V	XS-S-M-L

SIZE	ARTICLENUMBER	NOTES
SIZE XS	18YS0007	
SIZE S	18YS0008	
SIZE M	18YS0009	
SIZE L	18YS0010	



FLAT // teal blue / night black / palladium silver

SQUARE TREKKING B2.8



MODEL HIGHLIGHTS

- ▶ Stronger 500 Wh battery pack
- ▶ Shimano XT 9-speed rear derailleur
- ▶ Bosch Performance cruise motor

MODELL HIGHLIGHTS

- ▶ Größerer 500 Wh Akku
- ▶ Shimano XT 9-fach Schaltwerk
- ▶ Bosch Performance Cruise Motor

Hybride SQUARE Trekking AL	FSA CK-310 15T	GHOST SP-DC1 31.6 mm	Bosch Purion
SR Suntour NEX-E25 63 mm	Shimano CS-HG-200-9 11-36	Justek 3050 HRN	Bosch Performance Cruise
GHOST SQUARE Dia. 31.8 mm	Tektro HD-T 285 2/2 Piston 180 mm Disc	GHOST SQUARE Trekking Carrier	Bosch Power Pack 500 Wh
GHOST Low Rizer 680 mm Rise 15 mm Dia. 31.8 mm	Schwalbe Impac Bigpac 50-622 // Schwalbe Impac Bigpac 50-622	GHOST RG50	Bosch Charger 4 Ah
Shimano XT RD-M772 9-S Shadow Profile	Rudi Blackrock 622x21 mm 32H // Rudi Blackrock 622x21 mm 32H	Pletscher	16012
-	Formula DC 20 QR	Spanninga Brio XE 6V	EZ1954
Shimano Altus SL-M2000	Formula DC 22 QR	Spanninga Vivo XE 6V	S-M-L-XL

SIZE	ARTICLENUMBER	NOTES
SIZE S	18YS3037	
SIZE M	18YS3038	
SIZE L	18YS3039	
SIZE XL	18YS3040	































MODEL HIGHLIGHTS

- ▶ Stronger 500 Wh battery pack
- ▶ Shimano XT 9-speed rear derailleur

MODELL HIGHLIGHTS

- ▶ Größerer 500 Wh Akku
- ▶ Shimano XT 9-fach Schaltwerk

 Hybride SQUARE Trekking AL	 FSA CK-310 15T	 GHOST SP-DC1 31.6 mm	 Bosch Purion
 SR Suntour NEX-E25 63 mm	 Shimano CS-HG-200-9 11-36	 Justek 3050 DRN	 Bosch Performance Cruise
 GHOST SQUARE Dia. 31.8 mm	 Tektro HD-T 285 2/2 Piston 180 mm Disc	 GHOST SQUARE Trekking Carrier	 Bosch Power Pack 500 Wh
 GHOST Low Rizer 680 mm Rise 15 mm Dia. 31.8 mm	 Schwalbe Impac Bigpac 50-62Z // Schwalbe Impac Bigpac 50-62Z	 GHOST R650	 Bosch Charger 4 Ah
 Shimano XT RD-M772 9-S Shadow Profile	 Rodi Blackrock 622x21 mm 32H // Rodi Blackrock 622x21 mm 32H	 Pletscher	 16012
 -	 Formula DC 20 QR	 Spanninga Brio XE 6V	 EZ1954
 Shimano Altus SL-M2000	 Formula DC 22 QR	 Spanninga Vivo XE 6V	 XS-S-M-L

SIZE	ARTICLENUMBER	NOTES
SIZE XS	18YS4019	
SIZE S	18YS4020	
SIZE M	18YS4021	
SIZE L	18YS4022	



FLAT // paltadium silver / night black

SQUARE TREKKING B1.8



MODEL HIGHLIGHTS

- ▶ Affordable entry with Bosch Performance Cruise motor
- ▶ 400 Wh battery pack with capable 4 Ah charger
- ▶ Bosch Purion display

MODELL HIGHLIGHTS

- ▶ Günstiger Einstieg mit Bosch Performance Cruise Motor
- ▶ 400 Wh Akku mit 4 Ah Ladegerät
- ▶ Bosch Purion Display

Hybride SQUARE Trekking AL	FSA CK-310 15T	GHOST SP-DC1 31.6 mm	Bosch Purion
SR Suntour NEX-E25 63 mm	Shimano CS-HG-200-9 11-36	Justek 3050 HRN	Bosch Performance Cruise
GHOST SQUARE Dia. 31.8 mm	Tektro HD-T 285 2/2 Piston 180 mm Disc	GHOST SQUARE Trekking Carrier	Bosch Power Pack 400 Wh
GHOST Low Rizer 680 mm Rise 15 mm Dia. 31.8 mm	Schwalbe Impac Bigpac 50-62Z // Schwalbe Impac Bigpac 50-62Z	GHOST RG50	Bosch Charger 4 Ah
Shimano Altus RD-M2000 9-S Shadow Design	Rudi Blackrock 622x21 mm 32H // Rudi Blackrock 622x21 mm 32H	Pletscher	16012
-	Formula DC 20 QR	Spanninga Brio XE 6V	EZ1954
Shimano Altus SL-M2000	Formula DC 22 QR	Spanninga Vivo XE 6V	S-M-L-XL

SIZE	ARTICLENUMBER	NOTES
SIZE S	18YS3031	
SIZE M	18YS3032	
SIZE L	18YS3033	
SIZE XL	18YS3034	































MODEL HIGHLIGHTS

- ▶ Affordable entry with Bosch Performance Cruise motor
- ▶ 400 Wh battery pack with capable 4 Ah charger
- ▶ Bosch Purion display

MODELL HIGHLIGHTS

- ▶ Günstiger Einstieg mit Bosch Performance Cruise Motor
- ▶ 400 Wh Akku mit 4 Ah Ladegerät
- ▶ Bosch Purion Display

 Hybride SQUARE Trekking AL	 FSA CK-310 15T	 GHOST SP-DC1 31.6 mm	 Bosch Purion
 SR Suntour NEX-E25 63 mm	 Shimano CS-HG-200-9 11-36	 Justek 3050 DRN	 Bosch Performance Cruise
 GHOST SQUARE Dia. 31.8 mm	 Tektro HD-T 285 2/2 Piston 180 mm Disc	 GHOST SQUARE Trekking Carrier	 Bosch Power Pack 400 Wh
 GHOST Low Rizer 680 mm Rise 15 mm Dia. 31.8 mm	 Schwalbe Impac Bigpac 50-62Z // Schwalbe Impac Bigpac 50-62Z	 GHOST R650	 Bosch Charger 4 Ah
 Shimano Altus RD-M2000 9-S Shadow Design	 Rodi Blackrock 622x21 mm 32H // Rodi Blackrock 622x21 mm 32H	 Pletscher	 16012
 -	 Formula DC 20 QR	 Spanninga Brio XE 6V	 EZ1954
 Shimano Altus SL-M2000	 Formula DC 22 QR	 Spanninga Vivo XE 6V	 XS-S-M-L

SIZE	ARTICLENUMBER	NOTES
SIZE XS	18YS4013	
SIZE S	18YS4014	
SIZE M	18YS4015	
SIZE L	18YS4016	

A photograph of two cyclists riding on a paved road that winds through a rocky, mountainous landscape. The cyclist in the foreground is wearing a white and black cycling jersey with red accents, a white helmet, and sunglasses. The cyclist behind him is also in similar attire. The road is flanked by a metal guardrail on the right and a steep, rocky cliff on the left. The sky is bright with scattered clouds. The number '18' is overlaid on the right side of the image.

18

GHOST

XS - XXL **ADIDAS TEAM REPLICA JERSEY SHORT**



night black / star white / riot red

adidas®

**ENG
DETAILS**

- ▶ One back pocket with elastic top; one concealed zip pocket on back left
- ▶ Jacquard upper back panel and mesh ventilation
- ▶ Folded cuffs with with 3 stripes

**GER
DETAILS**

- ▶ Tasche auf der Rückseite mit elastischem Abschluss; verdeckte Tasche links auf der Rückseite
- ▶ Jacquard- und Mesh-Einsätze im oberen Rückenbereich
- ▶ Umgeschlagene Bündchen mit 3 Streifen

● night black / star white / riot red

100 % Polyester

↑ Slim Fit

DESCRIPTION	DETAILS	ART.-NR.
Adidas Team Replica Jersey Short	XS	17173
Adidas Team Replica Jersey Short	S	17174
Adidas Team Replica Jersey Short	M	17175
Adidas Team Replica Jersey Short	L	17176
Adidas Team Replica Jersey Short	XL	17177
Adidas Team Replica Jersey Short	XXL	17178



S - XXL **AM VENT JERSEY 3/4**



night black / star white / riot red

**ENG
DETAILS**

- ▶ Laser-cut hole panel at back
- ▶ Wicking and fast drying MTB jersey
- ▶ Mesh inserts at side and neck for additional ventilation

**GER
DETAILS**

- ▶ Laserperforation am Rücken
- ▶ Feuchtigkeitsableitendes und schnell trocknendes MTB-Jersey
- ▶ Mesh-Einsätze an der Seite und am Hals für zusätzliche Belüftung

● night black / star white / riot red

Main: 100 % Polyester
Mesh Inserts: 95 % Polyester, 5 % Elastane

↑ Regular Fit

DESCRIPTION	DETAILS	ART.-NR.
AM Vent Jersey 3/4	S	16097
AM Vent Jersey 3/4	M	16098
AM Vent Jersey 3/4	L	16099
AM Vent Jersey 3/4	XL	16100
AM Vent Jersey 3/4	XXL	16101





night black / star white / riot red

S-XXL AM VENT JERSEY LONG

ENG DETAILS

- ▶ Laser-cut hole panel at back
- ▶ Wicking and fast drying MTB jersey
- ▶ Mesh inserts at back and neck for additional ventilation

GER DETAILS

- ▶ Laserperforation am Rücken
- ▶ Feuchtigkeitsableitendes und schnell trocknendes MTB-Jersey
- ▶ Mesh-Einsätze an der Seite und am Hals für zusätzliche Belüftung

● night black / star white / riot red

Main: 100 % Polyester
Mesh Inserts: 95 % Polyester, 5 % Elastane

↑ Regular Fit



DESCRIPTION	DETAILS	ART.-NR.
AM Vent Jersey long	S	16102
AM Vent Jersey long	M	16103
AM Vent Jersey long	L	16104
AM Vent Jersey long	XL	16105
AM Vent Jersey long	XXL	16106



night black / riot blue / riot red

S-XXL AM JERSEY LONG

ENG DETAILS

- ▶ Crew neck
- ▶ Wicking and fast drying MTB jersey
- ▶ Raglan sleeves

GER DETAILS

- ▶ Rundhals-Ausschnitt
- ▶ Feuchtigkeitsableitendes und schnell trocknendes MTB-Jersey
- ▶ Raglan-Ärmel

● night black / riot blue / riot red

100 % Polyester

↑ Regular Fit



DESCRIPTION	DETAILS	ART.-NR.
AM Jersey long	S	16112
AM Jersey long	M	16113
AM Jersey long	L	16114
AM Jersey long	XL	16115
AM Jersey long	XXL	16116

S-XXL **AM JERSEY 3/4**



night black / tan / riot red



**ENG
DETAILS**

- ▶ V-neck
- ▶ Wicking and fast drying MTB jersey
- ▶ Fit accomodates protectors underneath

**GER
DETAILS**

- ▶ V-Ausschnitt
- ▶ Feuchtigkeitsableitendes und schnell trocknendes MTB-Jersey
- ▶ Passform geeignet zum Tragen von Protektoren

● night black / tan / riot red

100 % Polyester

↑ Regular Fit

DESCRIPTION	DETAILS	ART.-NR.
AM Jersey 3/4	S	17131
AM Jersey 3/4	M	17132
AM Jersey 3/4	L	17133
AM Jersey 3/4	XL	17134
AM Jersey 3/4	XXL	17135

S-XXL **AM SHORTS**



night black / reef blue / riot red



**ENG
DETAILS**

- ▶ Light and quick drying fabric
- ▶ One zippered front pocket
- ▶ Large GHOST print on back

**GER
DETAILS**

- ▶ Leichtes und schnell trocknendes Material
- ▶ Eine Reißverschluss-Tasche vorne
- ▶ Großer GHOST Logo-Druck hinten

● night black / reef blue / riot red

90 % Polyester, 10 % Elastane

↑ Regular Fit

DESCRIPTION	DETAILS	ART.-NR.
AM Shorts	S	16122
AM Shorts	M	16123
AM Shorts	L	16124
AM Shorts	XL	16125
AM Shorts	XXL	16126



night black / forest green / riot red

S-3XL BIKE SHIRT LONG

ENG DETAILS

- ▶ Mesh inserts at underarm and back
- ▶ Snap buttons with wind protection on front
- ▶ Chest pocket with zipper

GER DETAILS

- ▶ Mesh-Unterarm- und Rückenbelüftung
- ▶ Druckknöpfe mit Windschutzleiste vorne
- ▶ Brusttasche mit Reißverschluss

- night black/forest green/riot red
- # Main: 60 % Polyester, 40 % Cotton, Inserts: 100 % Polyester
- ↑ Regular Fit

DESCRIPTION	DETAILS	ART.-NR.
Bike Shirt long	S	17019
Bike Shirt long	M	17020
Bike Shirt long	L	17021
Bike Shirt long	XL	17022
Bike Shirt long	XXL	17023
Bike Shirt long	3XL	17024



titanium gray / night black

S-XXL BIKE TEE GHOST

drirelease® FRESHGUARD®

ENG DETAILS

- ▶ Moisture wicking; regulates skin temperature
- ▶ Fast drying
- ▶ With FreshGuard® to control odor

GER DETAILS

- ▶ Feuchtigkeitstransport; reguliert die Hauttemperatur
- ▶ Schnell trocknend
- ▶ FreshGuard® Geruchsneutralisierung

- titanium gray / night black
- # 85 % Polyester, 15 % Cotton (dri-release®)
- ↑ Regular Fit

DESCRIPTION	DETAILS	ART.-NR.
Bike Tee GHOST	S	17096
Bike Tee GHOST	M	17097
Bike Tee GHOST	L	17098
Bike Tee GHOST	XL	17099
Bike Tee GHOST	XXL	17100



S-XXL **BIKE TEE GHOST**

drirelease FRESHGUARD®



night black / riot red



**ENG
DETAILS**

- ▶ Moisture wicking; regulates skin temperature
- ▶ Fast drying
- ▶ With FreshGuard® to control odor

**GER
DETAILS**

- ▶ Feuchtigkeitstransport; reguliert die Hauttemperatur
- ▶ Schnell trocknend
- ▶ FreshGuard® Geruchsneutralisierung

● night black / riot red

85 % Polyester, 15 % Cotton (dri-release®)

↑ Regular Fit

DESCRIPTION	DETAILS	ART.-NR.
Bike Tee GHOST	S	17101
Bike Tee GHOST	M	17102
Bike Tee GHOST	L	17103
Bike Tee GHOST	XL	17104
Bike Tee GHOST	XXL	17105

S-XXL **TEE CIRCLE**



smoke white / star white



**ENG
DETAILS**

- ▶ Circle crack print
- ▶ Classic crew-neck design
- ▶ 100% cotton

**GER
DETAILS**

- ▶ Circle Crack-Druck
- ▶ Klassischer Rundhals-Ausschnitt
- ▶ 100% Baumwolle

● smoke white / star white

100 % Cotton

↑ Fitted

DESCRIPTION	DETAILS	ART.-NR.
Tee CIRCLE	S	16242
Tee CIRCLE	M	16243
Tee CIRCLE	L	16244
Tee CIRCLE	XL	16245
Tee CIRCLE	XXL	16246



night black / riot red

128-176 TEE RIOT KID

ENG DETAILS

- ▶ RIOT KID print
- ▶ Classic crew-neck design
- ▶ 100% cotton

GER DETAILS

- ▶ RIOT KID-Druck
- ▶ Klassischer Rundhals-Ausschnitt
- ▶ 100% Baumwolle

● night black/riot red

■ 100% Cotton

↑ Regular Fit

DESCRIPTION	DETAILS	ART.-NR.
Tee RIOT Kid	128	16177
Tee RIOT Kid	140	16178
Tee RIOT Kid	152	16179
Tee RIOT Kid	164	16180
Tee RIOT Kid	176	16181



star white / fuchsia pink

128-176 TEE GIRL KID

ENG DETAILS

- ▶ Glitter logo print
- ▶ Classic crew-neck design
- ▶ 100% Cotton

GER DETAILS

- ▶ Glitzer Logo-Druck
- ▶ Klassischer Rundhals-Ausschnitt
- ▶ 100% Baumwolle

● star white/fuchsia pink

■ 100% Cotton

↑ Regular Fit

DESCRIPTION	DETAILS	ART.-NR.
Tee Girl Kid	128	16187
Tee Girl Kid	140	16188
Tee Girl Kid	152	16189
Tee Girl Kid	164	16190
Tee Girl Kid	176	16191



XS - XL CROSS JERSEY SHORT WOMEN



night black / riot green / dark fuchsia pink



ENG DETAILS

- ▶ Excellent moisture management and wicking qualities
- ▶ 3 open back pockets
- ▶ Silicone gripper at bottom

GER DETAILS

- ▶ Hohe Atmungsaktivität und sehr guter Feuchtigkeitsabtransport
- ▶ Drei Rückentaschen hinten
- ▶ Silikonabschluss am Saum

🌑 night black / riot green / dark fuchsia pink

🏴󠁧󠁢󠁥󠁮󠁧󠁿 100 % Polyester

👤 Slim Fit

DESCRIPTION	DETAILS	ART.-NR.
Cross Jersey Short Women	XS	17081
Cross Jersey Short Women	S	17082
Cross Jersey Short Women	M	17083
Cross Jersey Short Women	L	17084
Cross Jersey Short Women	XL	17085

XS - XL AM JERSEY 3/4 WOMEN



titanium gray / riot red / monarch orange



ENG DETAILS

- ▶ Trendy V-neck
- ▶ Wicking and fast-drying MTB jersey
- ▶ Raglan sleeves

GER DETAILS

- ▶ Modischer V-Ausschnitt
- ▶ Feuchtigkeitsableitendes und schnell trocknendes MTB-Jersey
- ▶ Raglan-Ärmel

🌑 titanium gray / riot red / monarch orange

🏴󠁧󠁢󠁥󠁮󠁧󠁿 100 % Polyester

👤 Regular Fit

DESCRIPTION	DETAILS	ART.-NR.
AM Jersey 3/4 Women	XS	17086
AM Jersey 3/4 Women	S	17087
AM Jersey 3/4 Women	M	17088
AM Jersey 3/4 Women	L	17089
AM Jersey 3/4 Women	XL	17090



titanium gray / night black

XS - XL BIKE TEE GHOST WOMEN

drirelease[®] FRESHGUARD[®]

ENG DETAILS

- ▶ Moisture wicking; regulates skin temperature
- ▶ Fast drying
- ▶ With FreshGuard[®] to control odor

GER DETAILS

- ▶ Feuchtigkeitsabtransport; reguliert die Hauttemperatur
- ▶ Schnell trocknend
- ▶ FreshGuard[®] Geruchsneutralisierung

titanium gray / night black

85 % Polyester, 15 % Cotton (dri-release[®])

Slim Fit

DESCRIPTION	DETAILS	ART.-NR.
Bike Tee GHOST Women	XS	17106
Bike Tee GHOST Women	S	17107
Bike Tee GHOST Women	M	17108
Bike Tee GHOST Women	L	17109
Bike Tee GHOST Women	XL	17110



night black / riot red

XS - XL BIKE TEE GHOST WOMEN

drirelease[®] FRESHGUARD[®]

ENG DETAILS

- ▶ Moisture wicking; regulates skin temperature
- ▶ Fast drying
- ▶ With FreshGuard[®] to control odor

GER DETAILS

- ▶ Feuchtigkeitsabtransport; reguliert die Hauttemperatur
- ▶ Schnell trocknend
- ▶ FreshGuard[®] Geruchsneutralisierung

night black / riot red

85 % Polyester, 15 % Cotton (dri-release[®])

Slim Fit

DESCRIPTION	DETAILS	ART.-NR.
Bike Tee GHOST Women	XS	17111
Bike Tee GHOST Women	S	17112
Bike Tee GHOST Women	M	17113
Bike Tee GHOST Women	L	17114
Bike Tee GHOST Women	XL	17115



XS - XL CASUAL SHORTS WOMEN

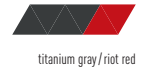

titanium gray / riot red



ENG DETAILS

- ▶ Casual style
- ▶ Premium-quality material
- ▶ Two front and back pockets

GER DETAILS

- ▶ Casual Shorts
- ▶ Hochwertiges Material
- ▶ Zwei Taschen vorne und hinten

● titanium gray / riot red

99 % Cotton, 1 % Elastane

↑ Regular Fit

DESCRIPTION	DETAILS	ART.-NR.
Casual Shorts Women	XS	17125
Casual Shorts Women	S	17126
Casual Shorts Women	M	17127
Casual Shorts Women	L	17128
Casual Shorts Women	XL	17129

XS - XL CASUAL SHORTS WOMEN



fuchsia pink / night black



ENG DETAILS

- ▶ Casual style
- ▶ Premium-quality material
- ▶ Two front and back pockets

GER DETAILS

- ▶ Casual Shorts
- ▶ Hochwertiges Material
- ▶ Zwei Taschen vorne und hinten

● fuchsia pink / night black

99 % Cotton, 1 % Elastane

↑ Regular Fit

DESCRIPTION	DETAILS	ART.-NR.
Casual Shorts Women	XS	17071
Casual Shorts Women	S	17072
Casual Shorts Women	M	17073
Casual Shorts Women	L	17074
Casual Shorts Women	XL	17075



riot red / night black

54-61 HELMET ALLTRACK BY CRATONI

ENG DETAILS

- ▶ In-mold technology for increased safety
- ▶ Multifunctional camera mounting with safety release
- ▶ 17 Air vents, 320 gram

GER DETAILS

- ▶ In-Mold Technologie für erhöhte Sicherheit
- ▶ Multifunktionale Kamerafixierung mit Sicherheitsauslösung
- ▶ 17 Ventilationsöffnungen, 320 Gramm

riot red / night black

DESCRIPTION	DETAILS	ART.-NR.
Helmet AllTrack by Cratoni	54-58 cm	18002
Helmet AllTrack by Cratoni	58-61 cm	18003



titanium gray / night black / riot red

54-62 HELMET CLASSIC PLUS

ENG DETAILS

- ▶ Double In-Mold technology
- ▶ MIPS® Multidirectional Impact Protection System for additional protection
- ▶ 23 Vents

GER DETAILS

- ▶ Double In-Mold-Technologie
- ▶ MIPS®, Multidirectional Impact Protection System für zusätzlichen Schutz
- ▶ 23 Ventilationsöffnungen

titanium gray / night black / riot red

DESCRIPTION	DETAILS	ART.-NR.
Helmet Classic Plus	54-58 cm	17055
Helmet Classic Plus	58-62 cm	17056



54 - 62 **HELMET CLASSIC PLUS**



tan / night black / riot red



**ENG
DETAILS**

- ▶ Double In-Mold technology
- ▶ MIPS®, Multidirectional Impact Protection System for additional protection
- ▶ 23 Vents

**GER
DETAILS**

- ▶ Double In-Mold-Technologie
- ▶ MIPS®, Multidirectional Impact Protection System für zusätzlichen Schutz
- ▶ 23 Ventilationsöffnungen

tan / night black / riot red

DESCRIPTION	DETAILS	ART.-NR.
Helmet Classic Plus	54-58 cm	17057
Helmet Classic Plus	58-62 cm	17058

53 - 63 **HELMET CLASSIC**



reef blue / monarch orange



**ENG
DETAILS**

- ▶ In-Mold technology for increased safety
- ▶ Lightweight and sturdy
- ▶ 21 Vents, 280 gram

**GER
DETAILS**

- ▶ In-Mold-Technologie für erhöhte Sicherheit
- ▶ Leicht und stabil
- ▶ 21 Ventilationsöffnungen, 280 Gramm

reef blue / monarch orange

DESCRIPTION	DETAILS	ART.-NR.
Helmet Classic	53-58 cm	17059
Helmet Classic	58-63 cm	17060



night blue / reef blue

53-63 HELMET CLASSIC

ENG DETAILS

- ▶ In-Mold technology for increased safety
- ▶ Lightweight and sturdy
- ▶ 21 Vents, 280 gram

GER DETAILS

- ▶ In-Mold-Technologie für erhöhte Sicherheit
- ▶ Leicht und stabil
- ▶ 21 Ventilationsöffnungen, 280 Gramm

🕒 night blue / reef blue

DESCRIPTION	DETAILS	ART.-NR.
Helmet Classic	53-58 cm	17061
Helmet Classic	58-63 cm	17062



night black / riot green

53-63 HELMET CLASSIC

ENG DETAILS

- ▶ In-Mold technology for increased safety
- ▶ Lightweight and sturdy
- ▶ 21 Vents, 280 gram

GER DETAILS

- ▶ In-Mold-Technologie für erhöhte Sicherheit
- ▶ Leicht und stabil
- ▶ 21 Ventilationsöffnungen, 280 Gramm

🕒 night black / riot green

DESCRIPTION	DETAILS	ART.-NR.
Helmet Classic	53-58 cm	17063
Helmet Classic	58-63 cm	17064



53 - 63 **HELMET CLASSIC**



star white / violet



**ENG
DETAILS**

- ▶ In-Mold technology for increased safety
- ▶ Lightweight and sturdy
- ▶ 21 Vents, 280 gram

**GER
DETAILS**

- ▶ In-Mold-Technologie für erhöhte Sicherheit
- ▶ Leicht und stabil
- ▶ 21 Ventilationsöffnungen, 280 Gramm

● star white / violet

DESCRIPTION	DETAILS	ART.-NR.
Helmet Classic	53-58 cm	17065
Helmet Classic	58-63 cm	17066

53 - 63 **HELMET CLASSIC**



night black / dark fuchsia pink



**ENG
DETAILS**

- ▶ In-Mold technology for increased safety
- ▶ Lightweight and sturdy
- ▶ 21 Vents, 280 gram

**GER
DETAILS**

- ▶ In-Mold-Technologie für erhöhte Sicherheit
- ▶ Leicht und stabil
- ▶ 21 Ventilationsöffnungen, 280 Gramm

● night black / dark fuchsia pink

DESCRIPTION	DETAILS	ART.-NR.
Helmet Classic	53-58 cm	17067
Helmet Classic	58-63 cm	17068



titanium gray / monarch orange

53-63 HELMET CLASSIC

ENG DETAILS

- ▶ In-Mold technology for increased safety
- ▶ Lightweight and sturdy
- ▶ 21 Vents, 280 gram

GER DETAILS

- ▶ In-Mold-Technologie für erhöhte Sicherheit
- ▶ Leicht und stabil
- ▶ 21 Ventilationsöffnungen, 280 Gramm

🕒 titanium gray / monarch orange



DESCRIPTION	DETAILS	ART.-NR.
Helmet Classic	53-58 cm	17069
Helmet Classic	58-63 cm	17070



night black / riot red

AMR BIKEPACKING SET HARDTAIL

ENG DETAILS

- ▶ Durable Cordura Fabric
- ▶ Removable drybags
- ▶ Recycled materials

GER DETAILS

- ▶ Haltbares Cordura Material
- ▶ Herausnehmbare Drybags
- ▶ Hergestellt aus recyceltem Material

● night black / riot red

⚡ 100 % Polyester (Cordura® 3000 / 6000 Ripstop EcoMade)



DESCRIPTION	DETAILS	ART.-NR.
Amr Bikepacking Set Hardtail	night black / riot red	17141



night black / riot red

AMR BIKEPACKING SET FULLY

ENG DETAILS

- ▶ Durable Cordura Fabric
- ▶ Removable drybags
- ▶ Recycled materials

GER DETAILS

- ▶ Haltbares Cordura Material
- ▶ Herausnehmbare Drybags
- ▶ Hergestellt aus recyceltem Material

● night black / riot red

⚡ 100 % Polyester (Cordura® 3000 / 6000 Ripstop EcoMade)



DESCRIPTION	DETAILS	ART.-NR.
AMR Bikepacking Set Fully	night black / riot red	17130

AMR BIKEPACKING



night black / riot red



HINWEIS: Die AMR Accessory Pocket (Handlebar) lässt sich nur zusammen mit der AMR Front Pack montieren
NOTE: The AMR Accessory Pocket (Handlebar) can only be mounted in combination with the AMR Front Pack

ENG DETAILS

- ▶ Durable Cordura® Fabric
- ▶ Removable drybags
- ▶ Recycled materials

GER DETAILS

- ▶ Haltbares Cordura® Material
- ▶ Herausnehmbare Drybags
- ▶ Hergestellt aus recyceltem Material

●	night black / riot red
#	100 % Polyester (Cordura® 3000 / 6000 Ripstop EcoMade)

DESCRIPTION	DETAILS	ART.-NR.
1. AMR Accessory Pocket (Handlebar)	night black / riot red	17002
2. AMR Front Pack	night black / riot red	17001
3. AMR Frame Pack Hardtail	night black / riot red	17116
4. AMR Frame Pack Fully	night black / riot red	17003
5. AMR Rear Pack	night black / riot red	17000

AMR BACKPACK



night black



ENG DETAILS

- ▶ SAS-TEC certified back protector
- ▶ Multiple pockets to fit your organization style
- ▶ Integrated helmet holder and rain cover

GER DETAILS

- ▶ SAS-Tech-zertifizierter Rückenprotektor
- ▶ Verschiedene Taschen für perfektes Packen
- ▶ Integrierte Helmhalterung und Regenabdeckung

●	night black
#	100 % Polyester (Cordura 3000 / 6000 Ripstop EcoMade)

DESCRIPTION	DETAILS	ART.-NR.
AMR Backpack	15L	17004



night black / riot red

BIKE SADDLEBAG SMALL

ENG DETAILS

- ▶ Fast and simple Velcro straps
- ▶ Rear light holder
- ▶ With double-G print

GER DETAILS

- ▶ Schnelle, einfache Klettbefestigung
- ▶ Rücklichtaufnahme
- ▶ Double-G-Aufdruck

● night black / riot red

100 % Polyester



DESCRIPTION	DETAILS	ART.-NR.
Bike Saddlebag small	0.5l	16280



night black / riot red

BIKE SADDLEBAG BIG

ENG DETAILS

- ▶ Fast and simple Velcro straps
- ▶ Rear light holder
- ▶ With double-G print

GER DETAILS

- ▶ Schnelle, einfache Klettbefestigung
- ▶ Rücklichtaufnahme
- ▶ Double-G-Aufdruck

● night black / riot red

100 % Polyester



DESCRIPTION	DETAILS	ART.-NR.
Bike Saddlebag Big	1.0l + 0.2l	16281

TRAVELBAG SMALL



riot red / star white



ENG DETAILS

- ▶ Extendable telescope handle
- ▶ Padded comfort grips
- ▶ 2 smooth rollers

GER DETAILS

- ▶ Ausziehbarer Teleskopgriff
- ▶ Gepolsterte Teleskopgriffe
- ▶ Zwei leichtlaufende Rollen

● riot red / star white

100 % Polyester

DESCRIPTION	DETAILS	ART.-NR.
Travelbag small	40L + 5l	14046

WASH CENTER



riot red / star white



ENG DETAILS

- ▶ Large main compartment for easy access with all around zipper
- ▶ Net inner pockets
- ▶ Hanger hooks

GER DETAILS

- ▶ Großes, leicht zugängliches Hauptfach mit Rundum-Reißverschluss
- ▶ Netzinnetaschen
- ▶ Haken zum Aufhängen

● riot red / star white

100 % Polyester

DESCRIPTION	DETAILS	ART.-NR.
Wash Center		14047



microchip gray / night black

BEANIE AMR

● micro chip gray / night black

⚡ 50% Wool, 50% Acrylic

DESCRIPTION	DETAILS	ART.-NR.
Beanie AMR	one size	17033



night black / riot red

CAP RIOT

ENG DETAILS

- ▶ Snapback Cap
- ▶ 3D RIOT embroidery
- ▶ One size fits all

GER DETAILS

- ▶ Snapback Cap
- ▶ 3D RIOT Stickerei
- ▶ Einheitsgröße

● night black / riot red

⚡ 80% Polyacrylic, 20% Wool

DESCRIPTION	DETAILS	ART.-NR.
Cap RIOT	One Size	16347



CAP ASKET



ENG DETAILS

- ▶ Classic snapback
- ▶ ASKET embroidery
- ▶ Pre-curved brim

GER DETAILS

- ▶ Klassische Snapback Cap
- ▶ ASKET Stickerei
- ▶ Gebogener Schirm

● night black / star white / riot red

80% Polyacrylic, 20% Wool

DESCRIPTION	DETAILS	ART.-NR.
Cap ASKET	One Size	16349

CAP LECTOR



ENG DETAILS

- ▶ Snapback Cap
- ▶ 3D LECTOR embroidery
- ▶ Six-panel construction

GER DETAILS

- ▶ Snapback Cap
- ▶ 3D LECTOR Stickerei
- ▶ 6-teilige Konstruktion

● night black / riot red

80% Polyacrylic, 20% Wool

DESCRIPTION	DETAILS	ART.-NR.
Cap LECTOR	One Size	16348

CAP DOUBLE-G

☞ Main: 100 % Cotton, Front Panel: 100 % Polyester

DESCRIPTION	DETAILS	ART.-NR.
Cap double-G	night black / reef blue / monarch orange	17136
Cap Double-G	night black / titanium gray / riot red	17137



CAP TRUCKER

☞ Main: 100 % Polyester, Visor 100 % Cotton

DESCRIPTION	DETAILS	ART.-NR.
Cap Trucker	night black / titanium gray / amber yellow	17138
Cap Trucker	night black / arctic blue / amber yellow	17139



GHOST MUFFLER



ENG DETAILS

- ▶ Lightweight, ultra-versatile tubular headwear
- ▶ Seamless, stretchy polyester microfiber, can be worn in many different styles

GER DETAILS

- ▶ Leichtes und vielseitig tragbares Schlauchtuch
- ▶ Nahtlos, dehnbare Mikrofasermaterial, verschiedene Tragevarianten

100 % Polyester

DESCRIPTION	DETAILS	ART.-NR.
Muffler RIOT	night black / riot red	16262
Muffler AMR	night black / riot blue	16261
Muffler AMR	night black / tan / riot red	17036
Muffler LECTOR	night blue / reed blue	17117
Muffler LECTOR	monarch orange / night black	17118

S-XXL GLOVES SHORT



ENG DETAILS

- ▶ Easy slip-on wrist cuff fits comfortably
- ▶ Stretchable and abrasion resistant material at top of hand for maximum comfort and breathability
- ▶ Soft absorbent terry thumb

GER DETAILS

- ▶ Elastischer Slip-on-Bundabschluss
- ▶ Elastisches, abriebfestes Oberhandmaterial mit Oberhandmaterial mit hoher Atmungsaktivität und Tragekomfort
- ▶ Saugfähiges Frottee am Daumen

night black / riot red

Backhand: 100 % Polyamide
 Palm: 60 % Polyamide, 40 % Polyester
 Insert: 100 % Polyamide, contains non-textile parts of animal origin

DESCRIPTION	DETAILS	ART.-NR.
Gloves short	S	16337
Gloves short	M	16338
Gloves short	L	16339
Gloves short	XL	16340
Gloves short	XXL	16341



night black / riot red

S-XXL **GLOVES AM**

ENG DETAILS

- ▶ Easy slip-on wrist cuff fits comfortably
- ▶ Backhand in mesh for more breathability
- ▶ Soft absorbent terry sthumb

GER DETAILS

- ▶ Elastischer Slip-on-Bundabschluss
- ▶ Atmungsaktives Meshoberhandmaterial
- ▶ Saugfähiges Frottee am Daumen

● night black / riot red



Backhand: 100 % Polyamide
Palm: 60 % Polyamide / 40 % Polyester
Insert: 100 % Polyamide; contains non-textile parts of animal origin

DESCRIPTION	DETAILS	ART.-NR.
Gloves AM	S	16342
Gloves AM	M	16343
Gloves AM	L	16344
Gloves AM	XL	16345
Gloves AM	XXL	16346





night black / silver gray

MULTITOOL

ENG DETAILS

- ▶ Torx and Allen wrench
- ▶ GHOST branding

GER DETAILS

- ▶ Torx- und Inbusschlüssel
- ▶ GHOST Branding

DESCRIPTION	COLOR	ART.-NR.
Multitool	night black / silver gray	15359



GHOST MUD FLAP

ENG DETAILS

- ▶ Extra strong for perfect stiffness and durability; made of recyclable polypropylene
- ▶ Wheel size 20", 24", 26", 26"+, 27,5", 27,5"+, 29", 29"+
- ▶ With 33 g the fender is a real lightweight and recommended for all forms of racing use

GER DETAILS

- ▶ Extra stark für perfekte Steifigkeit und Dauerhaltbarkeit, hergestellt aus recyclefähigem Polypropylen (PP)
- ▶ Passende Laufradgrößen: 20", 24", 26", 26"+, 27,5", 27,5"+, 29", 29"+
- ▶ Mit 33 g ist der Fender ein echtes Leichtgewicht und für alle Formen des Raceeinsatzes empfehlenswert

DESCRIPTION	ART.-NR.
GHOST Mud Flap by Riesel design	FEF0017



PEDALS FLAT

night black / silver gray



ENG DETAILS

- ▶ CRO-Mo axle, sealed bearings
- ▶ Perfect grip, replaceable pins
- ▶ Lightweight, 300 g

GER DETAILS

- ▶ CRO-MO Achse, abgedichtete Lager
- ▶ Perfekter Grip, austauschbare Pins
- ▶ Sehr leicht, 300 g

DESCRIPTION	COLOR	ART.-NR.
Pedals Flat	night black / silver gray	16013

GRIP



DESCRIPTION	COLOR	ART.-NR.
Grip with end plugs without screw	night black	16002
Grip with end plugs without screw	night black	16003
Ergo Grip with screw	night black / white	15046
Ergo Grip with screw	White / night black	15047
Grip with plugs without screw	night black / gray	14057
Grip with plugs without screw	night black / green	14059
Grip with plugs without screw	night black / white	14060
Grip with plugs without screw	night black / red	14061
Grip with plugs and screws	night black / gray	14063
Grip with plugs and screws	night black / green	14066
Grip with plugs and screws	night black / white	14065
Grip with plugs and screws	night black / red	14464
Grip RIOT	green	15042
Grip RIOT	blue	15043
Grip RIOT	red	15044
Grip RIOT	night black	15045

AM HANDLEBAR

DESCRIPTION	COLOR	ART.-NR.
AM Rizer Handlebar 780 mm Rise 15° Back 9° 35 mm	night black	16006
AM Rizer Handlebar 780 mm Rise 15° Back 9° 35 mm	red	16007
AM Rizer Handlebar 780 mm Rise 15° Back 9° 35 mm	blue	16008
AM Rizer Handlebar 780 mm Rise 15° Back 9° 35 mm	green	16009
AM Rizer Handlebar Light 740 mm Rise 15° Back 9° 31.8 mm	night black	14142
AM Rizer Handlebar Light 720 mm Rise 10° Back 9° 31.8 mm	night black	14143
AM Rizer Handlebar Light 720 mm Rise 0° Back 9° 31.8 mm	night black	14144
AM Rizer Handlebar Light 740 mm Rise 10° Back 9° 31.8 mm	red	15030
AM Rizer Handlebar Light 740 mm Rise 10° Back 9° 31.8 mm	blue	15031
AM Rizer Handlebar Light 740 mm Rise 10° Back 9° 31.8 mm	green	15032

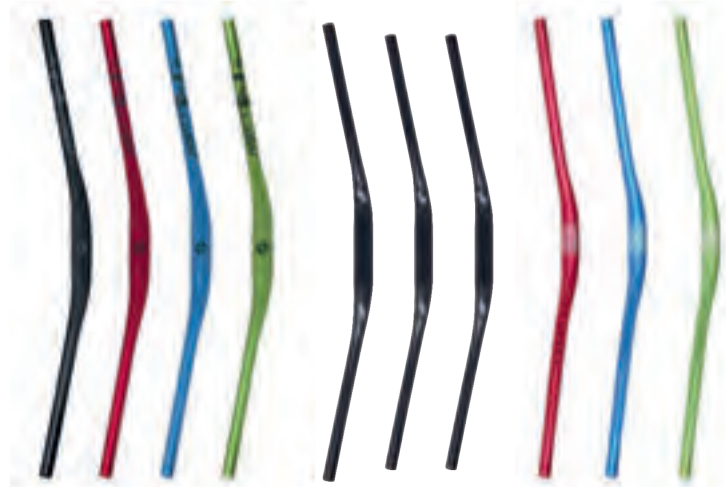

night black

STEM

ENG DETAILS

- ▶ Super strong
- ▶ Super light
- ▶ Stem Light GH1 and AM Stem RIOT with GHOST Branding

GER DETAILS

- ▶ Verwindungssteif
- ▶ Extra Leicht
- ▶ Stem Light GH1 und AM Stem RIOT mit GHOST Branding



DESCRIPTION	COLOR	ART.-NR.
Stem Light AS-M04 35mm 0° 35mm	night black	16004
Stem Light AS-M04 55mm 0° 35mm	night black	16005
Stem Light GH1 60 mm +/- 7° 31.8 mm	night black	14134
Stem Light GH1 80 mm +/- 7° 31.8 mm	night black	14135
Stem Light GH1 100 mm +/- 7° 31.8 mm	night black	14136
Stem Light AS-029 60 mm +/- 7° 31.8 mm	night black	14137
Stem Light AS-029 80 mm +/- 7° 31.8 mm	night black	14138
Stem Light AS-029 100 mm +/- 7° 31.8 mm	night black	14139
AM Stem RIOT 1 1/8 50 mm 31.8 mm	night black	15033
AM Stem RIOT 1 1/8 60 mm 31.8 mm	night black	15034
AM Stem RIOT 1 1/8 70 mm 31.8 mm	night black	15035

SADDLE



ENG DETAILS

- ▶ Men and women models for comfortable riding
- ▶ GHOST branding
- ▶ Available in two colors

GER DETAILS

- ▶ Verschiedene Modelle für Männer und Frauen für optimalen Komfort
- ▶ GHOST Branding
- ▶ In zwei Farben erhältlich

DESCRIPTION	COLOR	ART.-NR.
Saddle Comfort Lady	night black / gray	14085
Saddle Comfort Lady	white / gray	14086
Saddle Comfort Men	night black / gray	14159
Saddle Comfort Men	white / gray	14160

AM SEATPOST



ENG DETAILS

- ▶ Super light
- ▶ GHOST branding

GER DETAILS

- ▶ Extra leicht
- ▶ GHOST Branding

DESCRIPTION	COLOR	ART.-NR.
AM Seatpost Alloy Super Light 31.6 400 mm	night black	16010
AM Seatpost Alloy Super Light 27.2 400 mm	night black	14146
AM Seatpost Carbon Super Light 31.6 mm	night black	14147
AM Seatpost Carbon Super Light 27.2 mm	night black	14148

WATER BOTTLE

ENG DETAILS

- ▶ BPA-free
- ▶ Dishwasher safe
- ▶ Squeezable

GER DETAILS

- ▶ BPA-frei
- ▶ Spülmaschinenfest
- ▶ Leicht zu drücken

DESCRIPTION	COLOR	ART.-NR.
Water Bottle - 0,75 l	titanium gray / night black / riot red	16282
Water Bottle - 0,75 l	transparent / night black	17143
Water Bottle - 0,75 l	titanium gray / night black / riot red	17144
Water Bottle Small - 0,5 l	transparent / night black	16322
Water Bottle Small - 0,5 l	transparent / night black	17142



WATER BOTTLE CAGE

ENG DETAILS

- ▶ Lightweight
- ▶ Easy to use
- ▶ Fits your GHOST bike perfectly

GER DETAILS

- ▶ Leicht
- ▶ Einfach zu benutzen
- ▶ Passt perfekt zu deinem GHOST Bike

DESCRIPTION	COLOR	ART.-NR.
Water bottle cage Alloy	night black	15048
Water bottle cage Plastic	night black / red	14089
Water bottle cage Plastic	night black / green	14090
Water bottle cage Plastic	white / gray	14091
Water bottle cage Plastic	night black / gray	14108
Water bottle cage Plastic	riot blue	15037
Water bottle cage Plastic	riot green	15038
Water bottle cage Plastic	riot red	15039



FRAME PROTECTION



ENG DETAILS

- ▶ Fits perfectly onto your GHOST Bike
- ▶ Easy to mount

GER DETAILS

- ▶ Perfekter Sitz auf deinem GHOST Bike
- ▶ Leicht zu montieren

DESCRIPTION	COLOR	ART.-NR.
Chainstay protector size small	night black	14092
Chainstay protector size medium	night black	14093
Chainstay protector size large	night black	14094
RIOT protection sticker set	night black / carbon	15040
Protection kit	clear	15041

KICK STAND



ENG DETAILS

- ▶ Fits perfectly to your GHOST Bike
- ▶ Easy to mount

GER DETAILS

- ▶ Passt perfekt zu deinem GHOST Bike
- ▶ Leicht zu montieren

DESCRIPTION	COLOR	ART.-NR.
Kick Stand Center	night black	14162
Kick Stand Center black	night black	14161
Kick Stand Rear black (compatible with all SQUARE-models)	night black	15444
Kick Stand Rear black (compatible with all models, except SQUARE-models)	night black	15036

HEADSET

ENG DETAILS

- ▶ Complete headset
- ▶ Available in different sizes

GER DETAILS

- ▶ Komplettes Headset
- ▶ In verschiedenen Größen erhältlich

DESCRIPTION	ART.-NR.
Acros Headset fully integrated 44/56 mm	16011
Acros Headset fully integrated 44/56 mm	16012
Prestine PT-F2A Headset alloy, heavy duty, 1.5"	14102
Prestine PT-F2A Headset alloy AL6061T6 1 1/8", tapered 44/55, semi integrated	14103
Prestine PT-F-11BHS reducer Headset steel, 1 1/8", tapered 44/55, bottom 1 1/8" semi integrated	14104
Prestine PT-F-11BH Headset steel, 1 1/8" tapered, tapered 44/55, 1 1/8" semi integrated	14105
Prestine PT-1806H Headset steel, 1 1/8", 28.6x1, 1 1/8" 44/44 semi integrated	14106
Prestine PT-F-11S reducer Headset alloy AL6061T6, Tapered 44/55 bottom 1 1/8" semi integrated	14107



GHOST BIKE RACK

DESCRIPTION	ART.-NR.
GHOST Aluminium Bike Rack	18004



HANGER

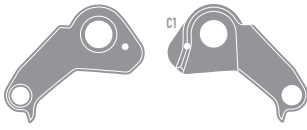

OUTSIDE / AUSSEN INSIDE / INNEN
Hanger for SRAM & Shimano standard

FITS

LECTOR UC 29 (9, 10, WC) '17, '18 | LECTOR UC X 29 (X8) '17, '18

ART.-NR.	DESCRIPTION	COLOR
FRHG0001	Hanger GHM11-001	black matt
FRSC0026	Screw CGR16-026 M3 x 21mm	



OUTSIDE / AUSSEN INSIDE / INNEN
Hanger for SRAM & Shimano standard

FITS

LECTOR UC 29 (9, 10, WC) '17, '18 | LECTOR UC X 29 (X8) '17, '18

ART.-NR.	DESCRIPTION	COLOR
FRHG0002	Hanger GHM11-002	black matt
FRSC0026	Screw CGR16-026 M3 x 21mm	

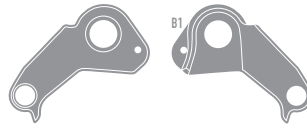

OUTSIDE / AUSSEN INSIDE / INNEN
Hanger for SRAM & Shimano standard

FITS

LECTOR LC KID 26 '17, '18 | LECTOR LC 29/27.5 '17, '18 | ASKET LC 27.5 '17, '18 | ASKET AL 29/27.5 '17, '18 | ROKET AL 27.5+ '17, '18 | HYBRIDE LANAQ AL 29/27.5+ '17, '18 | HYBRIDE KATO AL 29/27.5+ '17, '18 | HYBRIDE TERU X 27.5+ '18 | KATO X '18

ART.-NR.	DESCRIPTION	COLOR
FRHG0022	Hanger GHM09-022	black matt
FRSC0060	Screw GHT12-060 M4 x 18mm	

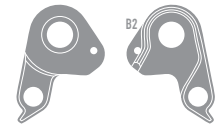

OUTSIDE / AUSSEN INSIDE / INNEN
Hanger for SRAM & Shimano standard

FITS

LECTOR LC KID 26 '17, '18 | LECTOR LC 29/27.5 '17, '18 | ASKET LC 27.5 '17, '18 | ASKET AL 29/27.5 '17, '18 | ROKET AL 27.5+ '17, '18 | HYBRIDE LANAQ AL 29/27.5+ '17, '18 | HYBRIDE KATO AL 29/27.5+ '17, '18 | HYBRIDE TERU X 27.5+ '18 | KATO X '18

ART.-NR.	DESCRIPTION	COLOR
FRHG0021	Hanger GHM09-021	black matt
FRSC0060	Screw GHT12-060 M4 x 18mm	



OUTSIDE / AUSSEN INSIDE / INNEN
Hanger dummy for Pinion

FITS

HAMR X '17, '18 | ROKET X '17, '18

ART.-NR.	DESCRIPTION	COLOR
FRHG0059	Hanger GHT12-059	black matt
FRSC0060	Screw GHT12-060 M4 x 18mm	

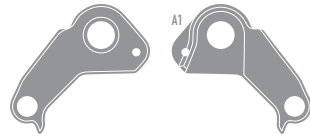

OUTSIDE / AUSSEN INSIDE / INNEN
Hanger for Shimano Direct Mount only

FITS

DREAMR '17 | SLAMR AL '17, '18 | SLAMR LC '17, '18 | SLAMR X AL '17, '18 | SLAMR X LC '17, '18 | FRAMR AL '17, '18 | FRAMR LC '17 | HAMR AL '17, '18 | HAMR LC '17, '18 | RIOT '17, '18 | PATH RIOT '17, '18 | HYBRIDE LANAQ FS '17, '18 | HYBRIDE KATO FS '17, '18 | KATO FS X '18

ART.-NR.	DESCRIPTION	COLOR
FRHG0058	Hanger GHT12-058	black matt
FRSC0060	Screw GHT12-060 M4 x 18mm	

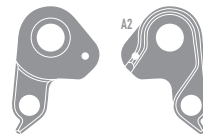

OUTSIDE / AUSSEN INSIDE / INNEN
Hanger for SRAM & Shimano standard

FITS

DREAMR '17 | SLAMR AL '17, '18 | SLAMR LC '17, '18 | SLAMR X AL '17, '18 | SLAMR X LC '17, '18 | FRAMR AL '17, '18 | FRAMR LC '17 | HAMR AL '17, '18 | HAMR LC '17, '18 | RIOT '17, '18 | PATH RIOT '17, '18 | HYBRIDE LANAQ FS '17, '18 | HYBRIDE KATO FS '17, '18 | KATO FS X '18

ART.-NR.	DESCRIPTION	COLOR
FRHG0057	Hanger GHT12-057	black matt
FRSC0060	Screw GHT12-060 M4 x 18mm	

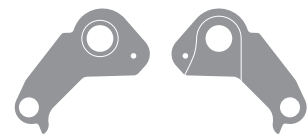

OUTSIDE / AUSSEN INSIDE / INNEN
Hanger for Shimano Direct Mount only

FITS

RIOT '14, '15, '16 | RIOT LT '15 | PATH RIOT '16 | SLAMR '16 | SLAMR X '16 | FRAMR '16 | DREAMR '16

ART.-NR.	DESCRIPTION	COLOR
EZ2038	Hanger GHT-12-001	black matt
SM1373	Screw GHO-AMR16SC-PM318	



OUTSIDE / AUSSEN INSIDE / INNEN
Hanger for SRAM & Shimano standard

FITS

RIOT '14, '15, '16 | RIOT LT '15 | PATH RIOT '16 | SLAMR '16 | SLAMR X '16 | FRAMR '16 | DREAMR '16

ART.-NR.	DESCRIPTION	COLOR
EZ2037	Hanger GHT-12-031	black matt
SM1373	Screw GHO-AMR16SC-PM318	

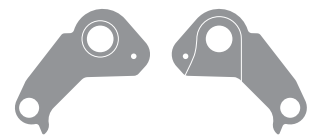

OUTSIDE / AUSSEN INSIDE / INNEN
Hanger for Shimano Direct Mount only

FITS

LECTOR '16 | ASKET '16

ART.-NR.	DESCRIPTION	COLOR
EZ2131	Hanger GHM09-010	black matt
SM1373	Screw GHO-AMR16SC-PM318	



OUTSIDE / AUSSEN INSIDE / INNEN
Hanger for SRAM & Shimano standard

FITS

LECTOR '16 | ASKET '16

ART.-NR.	DESCRIPTION	COLOR
EZ2132	Hanger GHM09-020	black matt
SM1373	Screw GHO-AMR16SC-PM318	

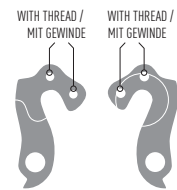

OUTSIDE / AUSSEN INSIDE / INNEN

FITS

TREKKING '12, '13 (5100-7500), '14 (5100-7500) | CROSS '12, '13, '14 | SPEEDLINE ALU* '12, '13, '14 (5700-7500), '15 (3, 4) | HTX 29" incl. Lector 29" '12, '13, '14 | 4X Team '12, '13 | 4X Comp '12, '13, '14 | SE '13, '14 (2000-8000) | MISS '13, '14 (2000-8000) | SE 29 '13, '14 (inkl. EBS) | HTX* '13, '14 | E-HYBRIDE Trekking (man/lady) '13, '14 | E-HYBRIDE Wave '13, '14 | E-HYBRIDE Cross (man/lady) '13, '14 | E-HYBRIDE SE 29 '13, '14 | LANAQ incl. PRO '15, '16 | KATO incl. PRO '15, '16 | TACANA incl. PRO '15, '16 | PANAMAQ '15 (5, 6, 7) | PANAMAQ X '15 (5, 6, 7, 8) | THE HOOD '15 | ANDASOL incl. LADY '15 (4, 6), '16 | ANDASOL X incl. LADY '15 (5, 7, 9), '16 (Cross) | HTX '15, '16 | NILA '15, '16 | KATO FS '16, '17, '18 | LANAQ FS '16, '17, '18 | SQUARE TREKKING '16, '17, '18 | SQUARE CROSS, CROSS X '16, '17, '18 | SQUARE URBAN, URBAN X '16 | KATO 29/27.5 '17, '18 | KATO X 29 '17, '18 | LANAQ 29/27.5 '17, '18 | ANDASOL CROSS, TREKKING, WAVE '17 | HYBRIDE KATO 29 '17 (2) | HYBRIDE LANAQ 29 '17 (2) | TERU incl. MISS '15, '16, '17 | HYBRIDE TERU X 29, '18 | HYBRIDE SQUARE CROSS, TREKKING '17, '18

PARTIALLY FITS

MISS '12 | SE '12 | PANAMAQ X '15 (2, 3, 4)

ART.-NR.	DESCRIPTION	COLOR
EZ1954	Hanger GRH-21bl	night black
FRSC0054	Screw 2x M4 x 8mm T20 black	

*Aluminium = no carbon (LECTOR), no Actinium, no Scandium

HANGER

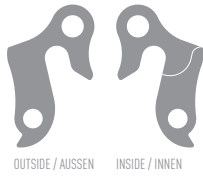

FITS

SE '14 (1100-1800) | MISS '14 (1100-1800) | LAWU '15, '16 | SONA '15, '16 | POWERKID 20 '15, '16 | POWERKID 24 '15, '16 | KATO 26 '17, '18 | LANAQ 26 '17, '18 | KATO KID 24 '17, '18 | LANAQ KID 24 '17, '18 | KATO KID 20 '17, '18 | LANAQ KID 20 '17, '18

ART.-NR.	DESCRIPTION	COLOR
EZ2036	Hanger GRH-24bl	night black
FRSC0052	Screw 69-035-090 Hex 5mm Inbus	
FRNT0052	Screw nut 69-035-090	

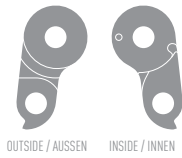

FITS

Road Rage '18 | Fire Road Rage '18 | Endless Road Rage '18 | Violent Road Rage '18

ART.-NR.	DESCRIPTION	COLOR
FRHG0003	Hanger RD 156	black matt
FRSC0003	Screw Hex 2,5 Inbus M3 x 6mm	



FITS

NIVOLET X '17, '18

ART.-NR.	DESCRIPTION	COLOR
FRHG0023	Hanger CGR16-023	black matt
FRSC0026	Screw CGR16-026 M3 x 21mm	

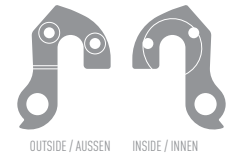

FITS

NIVOLET '15 (9, EBS) | NIVOLET TOUR LC '16 | NIVOLET RACE LC '16 | NIVOLET LC/UC '17, '18

ART.-NR.	DESCRIPTION	COLOR
EZ1859	Hanger GRH-26bl	night black
FRSC0054	Screw 2x M4 x 8mm T20 black	

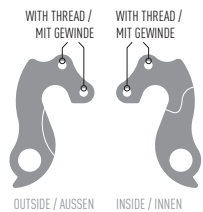

FITS

NIVOLET '15 (2) | NIVOLET Tour '16 (2,3) | NIVOLET AL '17, '18

ART.-NR.	DESCRIPTION	COLOR
EZ1858	Hanger GRH-25bl	night black
FRSC0054	Screw 2x M4 x 8mm T20 black	

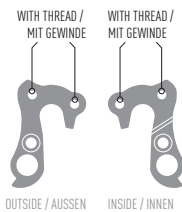

FITS

Race Lector '13 (Pro, 700D), '14 | Nivolet LC '15 (4, 5, 6, 7, 8) | Nivolet Tour Disc LC '16

ART.-NR.	DESCRIPTION	COLOR
EZ2010	Hanger GRH-23si	silver
EZ2011	Hanger GRH-23bl	night black
FRSC0054	Screw 2x M4 x 8mm T20 black	

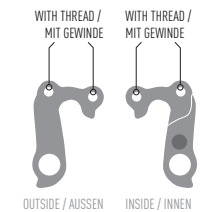

FITS

EBS RACE Lector '10, '11, '12 | RACE Lector '11, '12, '13 (Red) | RACE Lector Pro / SL '09, '10

ART.-NR.	DESCRIPTION	COLOR
EZ1566	Hanger GRH-15si	silver
FRSC0054	Screw 2x M4 x 8mm T20 black	

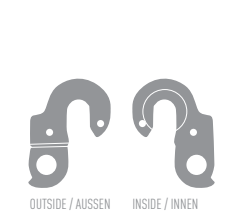

FITS

EBS RACE Alu* '07, '08, '09, '10, '11, '12, '13 | RACE Alu* '04, '05, '06, '07, '08, '09, '10, '11, '12, '13, '14 | RACE Scandium '05, '06 | RACE-LINE '09 | SPEEDLINE '07, '08, '09, '10, '11, '12, '14 (1800), '15 (2)

ART.-NR.	DESCRIPTION	COLOR
EZ1337	Hanger GRH-03si	silver
EZ1851	Hanger GRH-03bl	night black
FRSC0054	Screw 2x M4 x 8mm T20 black	

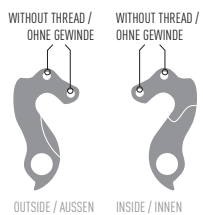

FITS

SPEEDLINE Lector '12, '13, '14

ART.-NR.	DESCRIPTION	COLOR
EZ1956	Hanger GRH-22si / bl	silver / black matt
FRSC0054	Screw 2x M4 x 8mm T20 black	

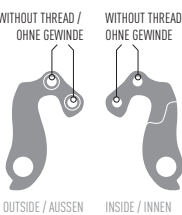

FITS

4X Team '11 | CROSS incl. Lady '11, '15 | EBS Alu* '10, '11, '12 | EBS HTX Lector '07, '08, '09, '10 | HTX Actinum '10, '11, '12 | HTX Lector '07, '08, '09, '10 | MISS Hardtail '10, '11, '12 | RACE Actinum '07, '08 | SE Alu* '10, '11, '12 | SE Lector '10 | PANAMA X '15 (2, 3, 4) - running change to EZ1954 from within

ART.-NR.	DESCRIPTION	COLOR
EZ1412	Hanger GRH-07bl	night black
FRSC0054	Screw 2x M4 x 8mm T20 black	

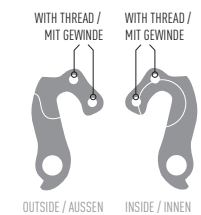

FITS

AMR Alu* '11, '12, '13 | AMR Lector '11, '12, '13 | MISS AMR '11, '12, '13, '14 | RT Actinum '11, '12, '13 | RT Lector '11, '12, '13 | HTX Lector '11, '12, '13 | EBS HTX Lector '11, '12, '13 | AMR 29 '13, '14 | ASX 650B '14 | MISS ASX 650B '14 | KATO FS incl. E. | '15 | LANAQ FS '15

ART.-NR.	DESCRIPTION	COLOR
AMR Alu* '10 AMR Lector '10 MISS AMR '10		
EZ1822	Hanger GRH-19bl	night black
FRSC0054	Screw 2x M4 x 8mm T20 black	

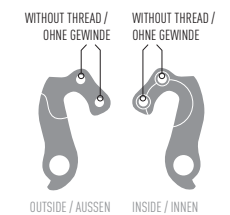

FITS

AMR Alu* '10 | AMR Lector '10 | MISS AMR '10

PARTIALLY FITS

AMR Alu* '11 | AMR Lector '11 | MISS AMR '11 | RZ Actinum '11 | RT Lector '11 | HTX Lector '11

ART.-NR.	DESCRIPTION	COLOR
EZ1621	Hanger GRH-18bl	night black
FRSC0054	Screw 2x M4 x 8mm T20 black	

*Aluminium = no carbon (LECTOR), no Actinum, no Scandium

HANGER

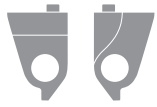

OUTSIDE / AUSSEN INSIDE / INNEN

FITS

AMR Plus Alu* '10, '11, '12, '13, '14 | AMR Plus Lector '10, '11, '12, '13, '14 | AMR Square '09 | DOWNHILL '11, '12, '13, '14, '15 | NORTHSHORE '11, '12, '13, '14, '15 | CAGUA (26") '12, '13 | CAGUA (27.5") '13, '14, '15 | AMR (27.5") Alu* '14, '15 | AMR incl. LT '15, incl. X '16 | TERU FS incl. LT '15, '16 | THE HOOD PRO '15, '16 | THE HOOD FS '15, '16 | AMR '16

ART.-NR.	DESCRIPTION	COLOR
EZ1567	Hanger GRH-14bl	night black
FRSC0053	Screw DTAMM6-30 M6 x30mm Torx Black	



OUTSIDE / AUSSEN INSIDE / INNEN

FITS

ASX '06, '07, '08 | RACE Alu* '99, '00, '01 | HYB ANDASOL WAVE, '18

ART.-NR.	DESCRIPTION	COLOR
EZ1338	Hanger GRH-04si	silver
FRSC0052	Screw 69-035-090 Hex 5mm Inbus	
FRNT0052	Screw Hex 69-035-090	



OUTSIDE / AUSSEN INSIDE / INNEN

FITS

AMR Alu* '06, '07, '08, '09 | AMR Lector '08, '09 | AMR Plus / LT (Long Travel) Alu* '08, '09 | AMR Plus Lector '09 | ASX '07 (only for frames with frame-no. A...) | ASX '09, '10, '11, '12, '13 | ASX Plus '10, '11 | ERT '06, '07, '08, '09 | FR Northshore '03, '04, '05, '06, '07, '08, '09 | HTX Actinum '07, '08, '09 | HTX Alu* '01, '02, '03, '04, '05, '06, '07 | MISS AMR '08, '09 | MISS Hardtail 5700 '06, '07 | MISS RT '04, '05, '06, '07, '08, '09, '10, '11, '12, '13, '14 | RT Actinum '07, '08, '09, '10 | RT Alu* '03, '04, '05, '06, '07 | RT Lector '08, '09, '10 | TR incl. Lady '08, '09, '10, '11, '13 (1300-1800), '14 (1100-1800, EBS) | PANAMA0 '15 (2, 3)

ART.-NR.	DESCRIPTION	COLOR
EZ1352	Hanger GRH-06bl	night black
FRSC0052	Screw 69-035-090 Hex 5 mm Inbus	
FRNT0052	Screw nut 69-035-090	



OUTSIDE / AUSSEN INSIDE / INNEN

FITS

4X '09, '10 | 4X Pro / Comp '11 | CROSS incl. Lady '04, '05, '06, '07, '08, '09, '10 | DUAL Comp / Pro '06, '07, '08 | EBS 1/2 Alu* '06, '07, '08, '09 | HTX Scandium '06 | HTX Team Edition '05, '06, '07 | MISS Hardtail '08, '09 | MISS Hardtail 3300 '07 | MISS Hardtail 4500 / 5100 '06, '07 | POWERKID 24" / MISSY 24" '06, '07, '08, '09, '10, '11, '12, '13, '14 | SE '05, '06, '07, '08, '09 | TR incl. Lady '04, '05, '06, '07

ART.-NR.	DESCRIPTION	COLOR
EZ1852	Hanger GRH-02bl	night black
FRSC0052	Screw 69-035-090 Hex 5mm Inbus	
FRNT0052	Screw nut 69-035-090	



OUTSIDE / AUSSEN INSIDE / INNEN

FITS

E-Hybride Trail '11, '12, '13, '14

ART.-NR.	DESCRIPTION	COLOR
EZ1855	Hanger GRH-20si	silver
FRSC0052	Screw 69-035-090 5mm Inbus	
FRNT0052	Screw nut 69-035-090	

RANGE OF USE // EINSATZBEREICHE

Each bicycle is designed for a specific range of use.
This section explains those ranges and the weight limits.

The **total weight (A)** equals the weight of the bicycle plus fully geared rider plus luggage.

The **riders weight (B)** equals the weight of the fully geared rider plus luggage.

Jedes Fahrrad wurde für einen bestimmten Gebrauch beziehungsweise Einsatzbereich entwickelt und gebaut. Dieser Abschnitt erklärt diese Einsatzbereiche und gibt Auskunft über das maximal zulässige Gesamtgewicht bzw. Fahrergewicht.

Das **Gesamtgewicht (A)** setzt sich zusammen aus dem Gewicht des Fahrrads, des fahrfertig bekleideten Fahrers und des Gepäcks.

Das **Fahrergewicht (B)** setzt sich zusammen aus dem Gewicht des fahrfertig bekleideten Fahrers und des Gepäcks.

A MAX. ALLOWED TOTAL WEIGHT //
MAXIMAL ZULÄSSIGES GESAMTGEWICHT

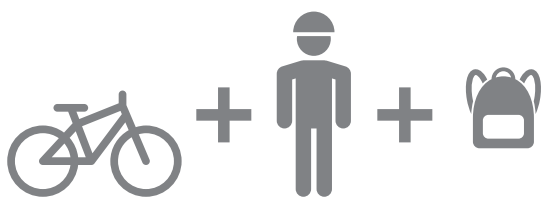

B MAX. ALLOWED RIDER'S WEIGHT //
MAXIMAL ZULÄSSIGES FAHRERGEWICHT

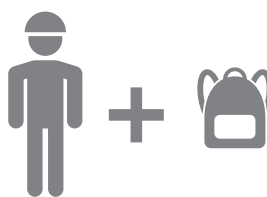

WARNING

Bikes always have to be used within and according to their range of use. If a bike is exposed to more stress than intended in its specific range of use, the bicycle and/or its parts may be damaged or break. A damaged or broken bike may be difficult or impossible to control and may cause severe crashes.

Always pay attention to the operating manual of the respective bicycle as well.

ACHTUNG







Fahrräder sind stets entsprechend ihrem zugelassenen Einsatzbereich zu verwenden. Wird ein Fahrrad höheren Belastungen ausgesetzt, als von uns in der jeweiligen Kategorie empfohlen, kann das zu Beschädigungen des Materials und sogar zum Bruch führen. Ein beschädigtes Fahrrad kann unkontrollierbar werden und dadurch schwere Stürze verursachen..

Beachten Sie auch die Betriebsanleitung des jeweiligen Fahrrads.







RANGE OF USE // EINSATZBEREICHE

MODEL // MODELL	RANGE OF USE CATEGORY // KATEGORIE EINSATZBEREICH	MAX. ALLOWED TOTAL WEIGHT (*max. allowed riders weight) // MAX. ZULÄSSIGES GESAMTGEWICHT (*max. zulässiges Fahrergewicht)
PATHRIOT	4	120 kg
RIOT	4	120 kg
H AMR X	4	120 kg
H AMR others / sonstige	4	120 kg
FR AMR	4	120 kg
SL AMR X	4	120 kg
SL AMR others / sonstige	4	120 kg
LECTOR WC 9 UC U	3	103,7 kg
LECTOR others / sonstige	3	120 kg
ASKET 4.6	3	120 kg
ASKET others / sonstige	4	120 kg
ROKET X	3	120 kg
ROKET others / sonstige	3	120 kg
KATO FS	3	120 kg
KATO X	3	120 kg
KATO others / sonstige	3	120 kg
LANAO FS	3	120 kg
LANAO X	3	120 kg
LANAO others / sonstige	3	120 kg
ROAD RAGE	2	120 kg
NIVOLET X	1	120 kg
NIVOLET others / sonstige	1	120 kg
SQUARE Speedline	2	140 kg
SQUARE Times	2	140 kg
SQUARE Urban	2	140 kg
SQUARE Cross X	2	140 kg
SQUARE Cross others / sonstige	2	140 kg
SQUARE Trekking	2	140 kg
KATO Kid 2.0 / R1.0	2	60 kg
KATO Kid D4.4 / 2.4	2	60 kg
LANAO Kid 2.0 / R1.0	2	60 kg
LANAO Kid D4.4 / 2.4	2	60 kg
POWERKID 16	0	36 kg*
POWERKID 12	0	36 kg*
POWERKIDDY 12	0	36 kg*
Hybride SLAMR X	4	140 kg
Hybride SLAMR others / sonstige	4	140 kg
Hybride LECTOR S 8.7+	3	120 kg
Hybride LECTOR others / sonstige	3	140 kg
Hybride KATO FS	3	140 kg
Hybride KATO others / sonstige	3	140 kg
Hybride LANA O FS	3	140 kg
Hybride LANA O others / sonstige	3	140 kg
Hybride TERU X	3	140 kg
Hybride TERU others / sonstige	3	140 kg
Hybride SQUARE Cross	2	140 kg
Hybride SQUARE Trekking	2	140 kg

RANGE OF USE // EINSATZBEREICHE

Symbol	Cycle category	Use
	<p>Category 0 cycles are generally 12" balance bikes and 12" or 16" children's bikes.</p>	<p>CATEGORY 0:</p> <ul style="list-style-type: none"> - For children aged 3 years and up - Only for use under the supervision of a parent or guardian - Not permitted on the road - Not permitted in competitions - Not suitable for jumps or acrobatics
	<p>Category 1 cycles are generally bikes, pedelecs and S-pedelecs in the style of racing bikes or fitness bikes (urban bikes).</p>	<p>CATEGORY 1:</p> <ul style="list-style-type: none"> - Solely for asphalt, concrete or paved roads and paths - Wheels must be kept in permanent contact with the ground - Permitted in competitions - Not suitable for drops, jumps or acrobatics
	<p>Category 2 cycles are generally bikes, pedelecs and S-pedelecs in the style of city, trekking, cross-trekking or cargo bikes, as well as 20" children's bikes and 24" junior bikes.</p>	<p>CATEGORY 2:</p> <ul style="list-style-type: none"> - Includes category 1, plus surfaced and naturally firm paths with moderate inclines - Can be ridden down steps of up to 15 cm / 5.9", e.g. kerbs - Not permitted in competitions - Not suitable for jumps or acrobatics
	<p>Category 3 cycles are generally bikes, pedelecs and S-pedelecs in the style of mountain bikes designed for cross-country, marathon and touring use, plus bikes in the cyclo-cross and all-track segments.</p>	<p>CATEGORY 3:</p> <ul style="list-style-type: none"> - Includes categories 1 and 2, plus rough trails with small obstacles, and unsurfaced routes that require good riding technique - Permitted in competitions - Drops and jumps permitted up to a max. height of 60 cm / 23.6" (with appropriate riding technique) - Not suitable for acrobatics
	<p>Category 4 cycles are generally bikes, pedelecs and S-pedelecs in the style of mountain bikes designed for all-mountain use.</p>	<p>CATEGORY 4:</p> <ul style="list-style-type: none"> - Includes categories 1, 2 and 3 - Larger obstacles and higher speeds require increased riding skills - Permitted in competitions - Drops and jumps permitted up to a max. height of 120 cm / 47.2" (with appropriate riding technique) - Not suitable for acrobatics
	<p>Category 5 cycles are generally bikes, pedelecs and S-pedelecs in the style of mountain bikes designed for enduro/freeride/downhill use.</p>	<p>CATEGORY 5:</p> <ul style="list-style-type: none"> - Includes categories 1, 2, 3 and 4, plus very fast and very demanding terrain with extreme inclines - Very high demands on riding skill - Permitted in competitions - Long drops and jumps permitted (with appropriate riding technique) - Not suitable for acrobatics

RANGE OF USE // EINSATZBEREICHE

Symbol	Fahrzeugkategorie	Nutzung
	<p>Fahrzeuge der Kategorie 0 sind in der Regel Kinderspielräder 12" und Kinderräder 12" und 16".</p>	<p>KATEGORIE 0:</p> <ul style="list-style-type: none"> - Für Kinder ab 3 Jahren - Verwendung nur unter Aufsicht Erziehungsberechtigter - Teilnahme an dem Straßenverkehr ist nicht gestattet - Teilnahme an Wettkämpfen ist nicht gestattet - Nicht für Sprünge und akrobatische Handlungen geeignet
	<p>Fahrzeuge der Kategorie 1 sind in der Regel Fahrräder, Pedelecs und S-Pedelecs des Typs Rennrad oder Fitness Bike (Urban Bike).</p>	<p>KATEGORIE 1:</p> <ul style="list-style-type: none"> - Ausschließlich für asphaltierte, betonierte oder gepflasterte Straßen und Wege - Permanenter Bodenkontakt der Laufräder muss gewährleistet sein - Die Teilnahme an Wettkämpfen ist gestattet - Nicht für Drops, Sprünge und akrobatische Handlungen geeignet
	<p>Fahrzeuge der Kategorie 2 sind in der Regel Fahrräder, Pedelecs und S-Pedelecs des Typs City-, Trekking-, Cross-Trekking- oder Lastenrad, außerdem Kinderräder 20" und Jugendräder 24".</p>	<p>KATEGORIE 2:</p> <ul style="list-style-type: none"> - Beinhaltet Kategorie 1 sowie befestigte und naturfeste Wege mit moderaten Steigungen - Absätze von bis zu 15 cm, z. B. Bordsteinkanten, können hinunter gefahren werden - Die Teilnahme an Wettkämpfen ist nicht gestattet - Nicht für Sprünge und akrobatische Handlungen geeignet
	<p>Fahrzeuge der Kategorie 3 sind in der Regel Fahrräder, Pedelecs und S-Pedelecs des Typs Mountainbike mit Einsatzzweck Cross Country, Marathon und Tour, sowie Fahrräder aus den Bereichen Cyclo-Cross und All Track.</p>	<p>KATEGORIE 3:</p> <ul style="list-style-type: none"> - Beinhaltet Kategorien 1 und 2 sowie raue Trails mit kleineren Hindernissen und unbefestigte Strecken, die eine gute Fahrtechnik erfordern - Die Teilnahme an Wettkämpfen ist gestattet - Drops und Sprünge bis zu einer Höhe von max. 60 cm sind zulässig (unter der Voraussetzung entsprechender Fahrtechnik) - Nicht für akrobatische Handlungen geeignet
	<p>Fahrzeuge der Kategorie 4 sind in der Regel Fahrräder, Pedelecs und S-Pedelecs des Typs Mountainbike mit Einsatzzweck Allmountain.</p>	<p>KATEGORIE 4:</p> <ul style="list-style-type: none"> - Beinhaltet Kategorien 1, 2 und 3 - Größere Hindernisse und höhere Geschwindigkeiten setzen gesteigertes fahrerisches Können voraus - Die Teilnahme an Wettkämpfen ist gestattet - Drops und Sprünge bis zu einer Höhe von max. 120 cm sind zulässig (unter der Voraussetzung entsprechender Fahrtechnik) - Nicht für akrobatische Handlungen geeignet
	<p>Fahrzeuge der Kategorie 5 sind in der Regel Fahrräder, Pedelecs und S-Pedelecs des Typs Mountainbike mit Einsatzzweck Enduro/Freeride/Downhill.</p>	<p>KATEGORIE 5:</p> <ul style="list-style-type: none"> - Beinhaltet Kategorien 1, 2, 3 und 4 sowie sehr schnell gefahrenes und sehr anspruchsvolles Gelände mit extremen Steigungen - Sehr hohe Ansprüche an das fahrerische Können - Die Teilnahme an Wettkämpfen ist gestattet - Weite Sprünge und Drops sind zulässig (unter der Voraussetzung entsprechender Fahrtechnik) - Nicht für akrobatische Handlungen geeignet

NEON COLORS // NEON FARBEN



PLEASE NOTE – NEON COLORS

Dear dealer and customer,

Neon colors truly do let our bikes stand out. Nevertheless, please be aware that neon colors may lose part of their intensity when exposed to direct sunlight over a longer period of time.

Therefore, we suggest to not expose the bikes unnecessarily to direct sunlight.

Should the bikes be on display, it is recommended either to use UV sun protection foil for the display windows or not to put them in a sunny place.

We ask for your understanding that warranty does not apply to color fading

NEON FARBEN – BITTE BEACHTEN

Sehr geehrter Händler und Kunde,

Neonfarben bringen unsere Räder richtig zum Strahlen. Wir bitten Sie daher zu beachten, dass Neonfarben unter längerer Einwirkung von Sonnenstrahlung dazu neigen, ihre Farbkraft zu verlieren.

Wir empfehlen daher, die Räder nicht unnötig lange direkter Sonnenstrahlung auszusetzen.

Sollten die Räder ausgestellt werden, ist es daher ratsam, die Schaufenster entweder mit UV-Schutzfolie zu versehen, oder die Räder an sonnengeschützten Stellen zu positionieren.

Wir bitten Sie um Verständnis, dass Garantieansprüche wegen Farbausbleichung nicht anerkannt werden können.

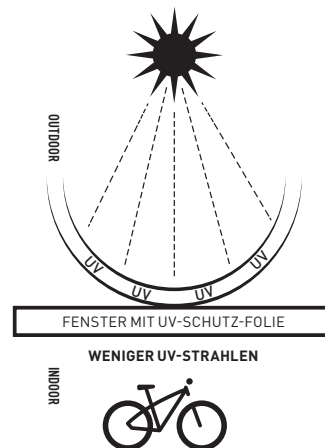
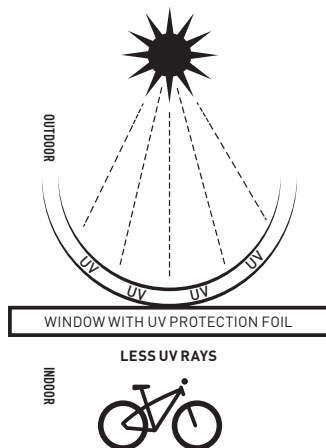

IMPRINT

PHOTOS

Jan Kasl

THANKS TO

All employees of GHOST-Bikes – to each one of you in our unique company who was a part of this long and sometimes difficult development process of our 2018 products which we now proudly present.

We are not liable for errors, changes or misprints.
Images might not represent the original.
© 2017 GHOST Bikes

Under certain circumstances, not all of the products shown in this catalogue might be available in all regions. Please contact your GHOST sales department for more information.

GHOST-Bikes GmbH

An der Tongrube 3
95652 Waldsassen
Germany

Tel: +49 (9632) 9255-0
Fax: +49 (9632) 9255-16
Email: info@GHOST-bikes.de
web: GHOST-bikes.com

Member of Accell Group

PHOTOS

Jan Kasl

DANK AN

Alle Mitarbeiter von GHOST-Bikes – jeden Einzelnen in unserer einmaligen Firma, der ein Teil dieses langen und manchmal auch harten Entwicklungsprozesses der 2018er-Produkte war, die wir nun mit Stolz präsentieren.

Irrtümer, Änderungen und Druckfehler vorbehalten.
Bilder können vom Original abweichen.
© 2017 GHOST Bikes

Unter Umständen sind nicht alle in diesem Katalog gezeigten Produkte in allen Regionen erhältlich, bitte kontaktiere dazu dein GHOST Vertriebs-Team.



GHOST-BIKES.COM

